



D

# PROGRAMM

Ab 2023





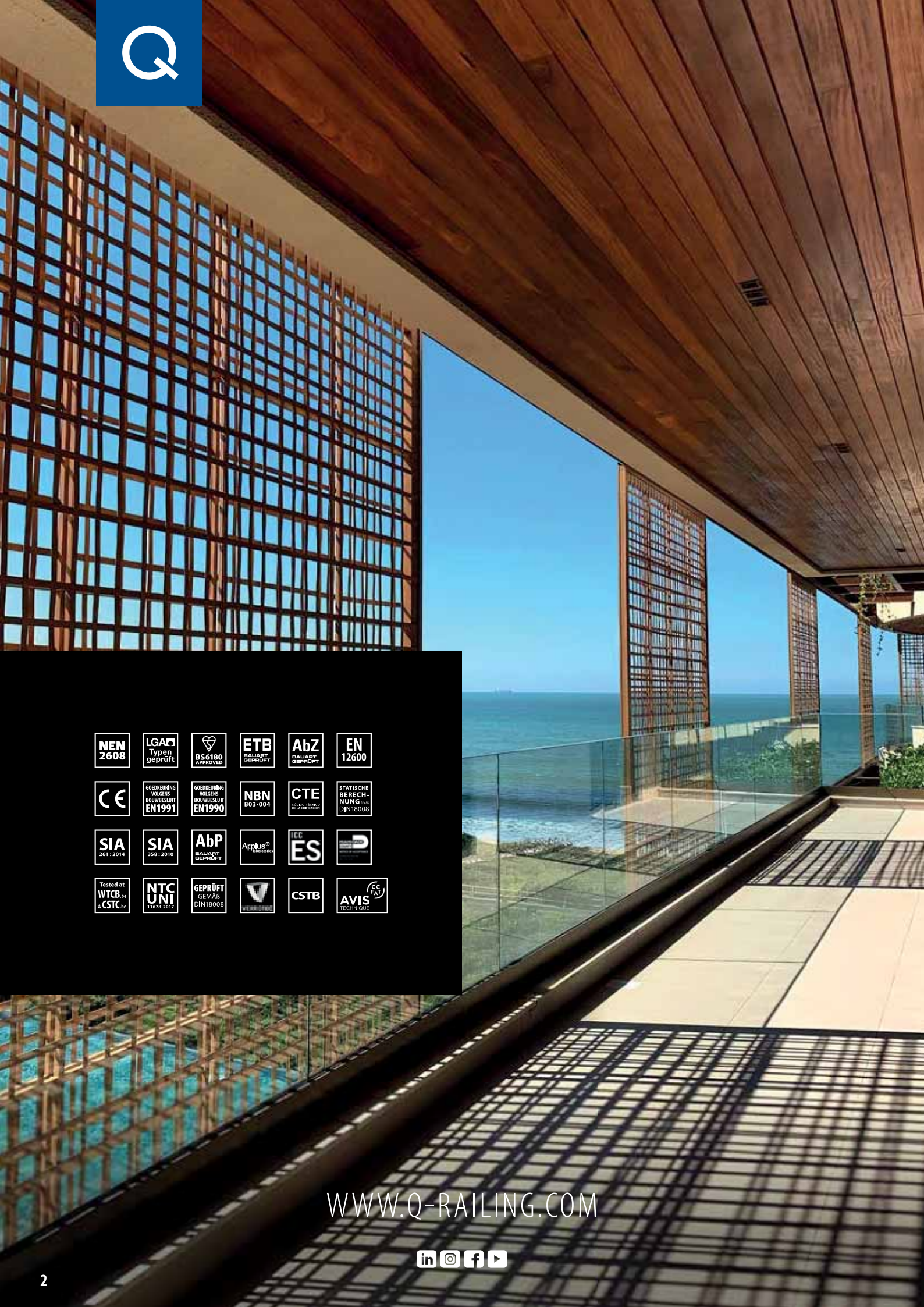

<b>NEN 2608</b>	<b>LGAM</b> Typen geprüft	<b>BS 6180</b> APPROVED	<b>ETB</b> BALAJART GEPRÜFT	<b>AbZ</b> BALAJART GEPRÜFT	<b>EN 12600</b>
<b>CE</b>	GOEDKEURING VOLGENS BOUWBESLUIT <b>EN1991</b>	GOEDKEURING VOLGENS BOUWBESLUIT <b>EN1990</b>	<b>NBN</b> B03-004	<b>CTE</b> CONFORME TECHNIQUE	STATISCHE BERECHNUNG GEMÄß <b>DIN18008</b>
<b>SIA</b> 261 : 2014	<b>SIA</b> 358 : 2010	<b>AbP</b> BALAJART GEPRÜFT	<b>AppPlus®</b> laboratoire	<b>ICC</b> <b>ES</b>	<b>D</b>
Tested at <b>WTCB</b> & <b>CSTC</b>	<b>NTC UNI</b> 11678-2017	GEPRÜFT GEMÄß <b>DIN18008</b>	<b>V</b>	<b>CSTB</b>	<b>AVIS</b> TECHNIQUE

WWW.Q-RAILING.COM





# WILLKOMMEN BEI DER PREMIUM MARKE FÜR GELÄNDERSYSTEME

Was bedeutet Premium für uns? Es bedeutet, dass wir nicht ruhen, bis wir die Perfektion erreicht haben, die Sie erwarten.

## PREMIUM IN JEDER HINSICHT

### Nur das Beste

- Gleichbleibende Qualität
- Hochwertige Materialien
- Makellose Oberflächen
- Extrem präzise Maße und minimale Toleranzen

### Erstaunlich schnell

- Alles sofort ab Lager lieferbar
- Schnelle Lieferung
- Fundierte technische Beratung
- Rund um die Uhr im Onlineshop bestellen

### Unbegrenzte Möglichkeiten

- Unzählige Produkte
- Zahlreiche Designvarianten
- Hier finden Sie alles, um ein komplettes Geländer oder Handläufe zu kreieren
- Kombinieren Sie die Komponenten nach Belieben und schaffen Sie einen individuellen Look

### 100% sicher

- Ausgiebige Tests im unternehmenseigenen Prüflabor
- Umfangreiche Prüfungen durch unabhängige, zertifizierte Prüfstellen und führende Behörden
- Testverfahren und behördliche Genehmigungen entsprechend der internationalen Bauvorschriften und Normen

### Ästhetik und Raffinesse

- Regelmäßige Produktinnovationen und Produktoptimierungen
- Vortreffliches Design
- Ausgeklügelte Details, die eine schnelle und einfache Montage ermöglichen

### Onlineangebot : [www.q-railing.com](http://www.q-railing.com)

- Montagevideos, BIM-Objekte, CAD-Zeichnungen und weitere technische Dokumente und Ausschreibungstexte
- Q-PAC (Professional Anchor Calculation) Software, mit der Sie genau den richtigen Q-railing Anker finden, den Sie benötigen
- Kataloge, Broschüren, Referenzprojekte und vieles mehr







# 1

## GANZGLAS- GELÄNDERSYSTEME

**SYSTEMÜBERSICHT**

6-7

**FINDEN SIE IHR PRODUKT**

8-9

PRODUKTE FÜR GELÄNDERBASIS

GLAS UND GLASVERBINDER

PRODUKTE FÜR HANDLÄUFE

### 26 - 185



# 2

## SYSTEME FÜR FRANZÖSISCHE BALKONE

**SYSTEMÜBERSICHT**

10-11

**FINDEN SIE IHR PRODUKT**

10-11

EASY GLASS® VIEW

EASY GLASS® MOD 6507-6508

MIT GLASKLEMMEN

MIT GLASADAPTERN

FENSTERABSTURZSTANGEN

### 186 - 231



# 3

## Q-LIGHTS SYSTEME

**SYSTEMÜBERSICHT**

12-13

**FINDEN SIE IHR PRODUKT**

12-13

SPOTLIGHT FÜR HANDLÄUFE

LINEAR LIGHT FÜR GLASLEISTENROHRE

LINEAR LIGHT FÜR HANDLÄUFE

### 232 - 265





# 4

## PFOSTENGELÄNDER-SYSTEME

<b>SYSTEMÜBERSICHT</b>	14 - 15
<b>FINDEN SIE IHR PRODUKT</b>	16 - 17
PRODUKTE FÜR GELÄNDERPFOSTEN	
PRODUKTE FÜR HANDLÄUFE	
FÜLLUNGEN	

**266 - 421**



# 5

## GLAS-BEFESTIGUNGEN

<b>FINDEN SIE IHRE GLASBEFESTIGUNG</b>	425 - 432
GLASKLEMMEN	432 - 444
GLASHALTER	446 - 447
GLASVERBINDER	448 - 450
SCHARNIERE UND TÜRRIEGEL	450 - 451
GLASADAPTER	453 - 455

**422 - 455**



# 6

## ZUBEHÖR

<b>ÜBERSICHT Q-SCREWS</b>	458
<b>FINDEN SIE DEN RICHTIGEN ANKER</b>	459 - 465
ANKER	466 - 469
SCHRAUBEN UND BEFESTIGUNGSMATERIAL	470 - 476
ERSATZMATERIAL FÜR GLASKLEMMEN UND -ADAPTER	477
BOHREN UND GEWINDESCHNEIDEN	478 - 479
MONTAGEZUBEHÖR	480 - 483
PFLEGE UND REINIGUNG	484
WERKZEUG	485 - 487
SYMBOLVERZEICHNIS	489

**456 - 489**





# 1

## GANZGLAS- GELÄNDERSYSTEME

### 26 - 185



EASY GLASS® SMART

≡ 12 - 21,52 mm ▲ ● H | IHI



EASY GLASS® SMART+

≡ 16,76 - 21,52 mm ▲ H | IHI

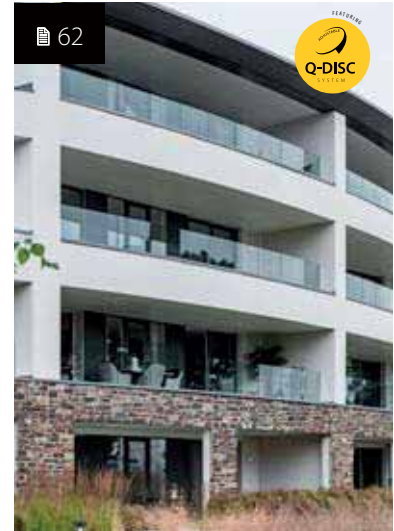

EASY GLASS® PRIME

≡ 16,76 - 25,52 mm ▲ H | IHI



EASY GLASS® MAX

≡ 19 - 31,52 mm ● IHI | IIII



EASY GLASS® UP

≡ 12 - 17,52 mm ● H | IHI



EASY GLASS® HYBRID

≡ 8 - 13,52 mm ● H | IHI



Eine optimale Nutzung von Licht und Raum ist entscheidend – egal ob es sich bei Ihrem Projekt um ein Einfamilienhaus oder ein Stadion für Tausende von Besuchern handelt.

Die Ganzglas-Geländersysteme von Q-railing helfen Ihnen dabei, maximale Transparenz und somit eine helle, offene Umgebung mit uneingeschränkter Sicht zu schaffen.



EASY GLASS® **STRONG**

≡ 21,52 - 33,04 mm ▲ | H | H | H



EASY GLASS® **SLIM**

≡ 12 - 21,52 mm ● H



EASY GLASS® **PRO**

≡ 12 - 21,52 mm ▲ ● H | H | H



EASY GLASS® **BODENGLASKLEMMEN**

≡ 12 - 21,52 mm ● H | H | H



EASY GLASS® **AIR**

≡ 15 - 21,52 mm ● H | H | H



EASY GLASS® **GLASADAPTER**

≡ 8 - 25,52 mm ▲ ● H | H | H

≡ = Glasstärke ▲ = Justierbar ● = Nicht justierbar

H = Leichte Beanspruchung | H | H = Mittlere Beanspruchung | H | H | H = Hohe Beanspruchung | H | H | H | H = Besonders hohe Beanspruchung



# 1

## GANZGLAS- GELÄNDERSYSTEME

### 26 - 185

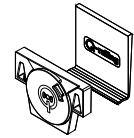
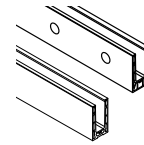

#### A

#### GELÄNDERBASIS

BODENPROFILE

GLASFIXIERUNG

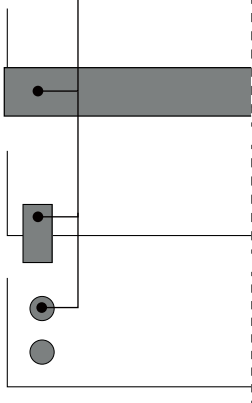

EASY GLASS® SMART	33, 36, 38, 44	31-32
EASY GLASS® SMART+	54, 55	53
EASY GLASS® PRIME	66, 68, 70, 76	65
EASY GLASS® STRONG	86, 88	85
EASY GLASS® SLIM	97, 99, 100	96
EASY GLASS® PRO	108, 110, 112, 114	106-107
EASY GLASS® MAX	119, 121, 122, 124	118
EASY GLASS® UP	130, 131	128
EASY GLASS® HYBRID	136	136
EASY GLASS® BODENGLASKLEMMEN		
EASY GLASS® AIR		
EASY GLASS® GLASADAPTER		

#### B

#### GLAS

Q-GLASS

GLASVERBINDER

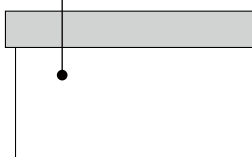

MAßGEFERTIGTES GLAS	160	162-164
GLAS AB LAGER	161	

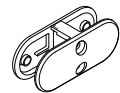

#### C

#### HANDLÄUFE

KANTENSCHUTZ

U-PROFILE

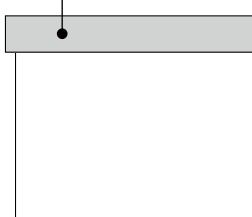

EASY GLASS® SMART	166	167
EASY GLASS® SMART+		
EASY GLASS® PRIME		
EASY GLASS® STRONG		
EASY GLASS® SLIM		
EASY GLASS® PRO		
EASY GLASS® MAX		
EASY GLASS® UP	166	167
EASY GLASS® HYBRID		
EASY GLASS® BODENGLASKLEMMEN		
EASY GLASS® AIR		
EASY GLASS® GLASADAPTER		

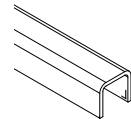
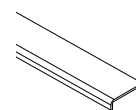



## SO FINDEN SIE GANZ EINFACH IHRE PRODUKTE

Unsere Geländersysteme bestehen in der Regel aus drei Segmenten: Geländerbasis **A**, Glas **B** und Handlauf **C**. Diese sind in verschiedene Produktgruppen unterteilt. Ermitteln Sie das Segment und die Produktgruppe - und finden Sie so auf Anhieb die gewünschten Artikel.

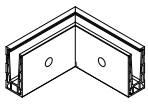
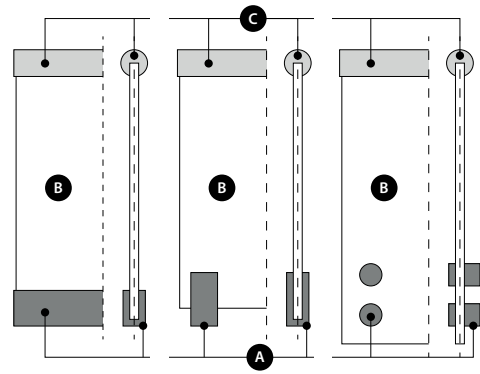

ECKEN

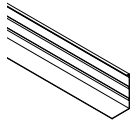

BLENDLEISTEN

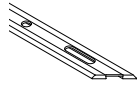

DRAINAGELEISTEN

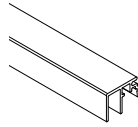

BAUANSCHLUSS-LEISTEN



BODENGLASKLEMMEN

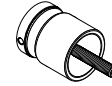

GLASADAPTER



BEFESTIGUNGS-MATERIAL

34, 37, 38, 45	42, 47	35, 41	37, 48-49			459-465
54-55	57	56	59-60			
66, 69, 70, 77	74, 79	67, 73	80-81			
86, 88	91	87, 90	92-93			
97, 99, 100	102	98				
109, 110, 112, 115	113, 115	109, 112				
123, 121, 122, 124	123, 125					
130, 131	132	133				
				142-145		
				148		
					152-159	

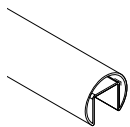

GLASLEISTENROHRE

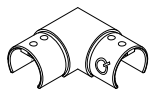

VERBINDER

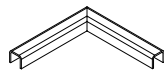

ECKEN



WANDFLANSCH



ENDSTÜCKE

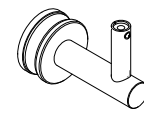

HANDLAUFSTÜTZEN

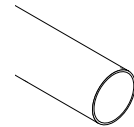

ROHRE

169-170, 174, 176, 178, 180, 182, 184	169, 171 - 173, 175, 177, 179, 181, 183, 185	166, 168, 174, 178	173, 177, 181, 182, 184	168, 169, 173, 174, 177, 178, 181, 182, 185	286, 297, 340-341, 365	285, 300, 351, 367
137-138			137-138			
169-170, 174, 176, 178, 180, 182, 184	169, 171 - 173, 175, 177, 179, 181, 183, 185 148	166, 168, 174, 178	173, 177, 181, 182, 184 149	168, 169, 173, 174, 177, 178, 181, 182, 185 149	286, 297, 340-341, 365	285, 300, 351, 367 149
	169, 171 - 173, 175, 177, 179, 181, 183, 185	166, 168, 174, 178	173, 177, 181, 182, 184	168, 169, 173, 174, 177, 178, 181, 182, 185	286, 297, 340-341, 365	285, 300, 351, 367



# 2

## SYSTEME FÜR FRANZÖSISCHE BALKONE

186 - 231



EASY GLASS® VIEW

12 - 21,52 mm



EASY GLASS® MOD 6507 / 6508

8 - 21,52 mm

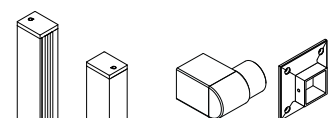

PROFILE ZUR  
WANDMONTAGE

WANDFLANSCH

### FRANZÖSISCHE BALKONE

EASY GLASS® VIEW	192-193, 195	
EASY GLASS® MOD 6507 / 6508		200-208
MIT GLASKLEMMEN		
MIT GLASADAPTERN		
FENSTERABSTURZSTANGEN		220-221, 223-230



Ein französischer Balkon bietet nicht nur ein Plus an Sicherheit, sondern verleiht der Fassade auch einen ausdrucksstarken Look. Damit Sie die passende Geländer-Lösung für Ihr Projekt finden, gibt es im Q-railing Sortiment eine große Auswahl an Komponenten für französische Balkone.



**MIT GLASKLEMMEN**

≡ 9,52 - 21,52 mm

● H | II



**MIT GLASADAPTERN**

≡ 8 - 31,52 mm

▲ H | II



**FENSTERABSTURZSTANGEN**

● H

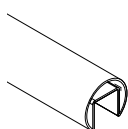

GLASLEISTENROHRE

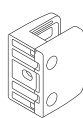

GLASKLEMMEN

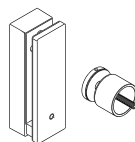

GLASADAPTER

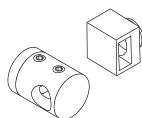

STABHALTER

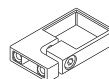

ROHRHALTER

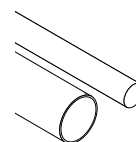

STAB UND ROHR



ENDSTÜCKE

						197
200-207, 209						
	211					
		213-217				
			219, 222	221	219-221, 223-231	219, 221-222, 225

≡ = Glasstärke   ▲ = Justierbar   ● = Nicht justierbar  
 H = Leichte Beanspruchung   II = Mittlere Beanspruchung



# 3

## Q-LIGHTS SYSTEME 232 - 265



Q-LIGHTS **SPOTLIGHT**

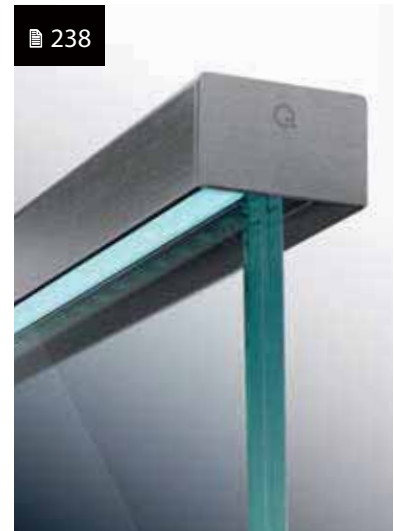

Q-LIGHTS **LINEAR LIGHT**

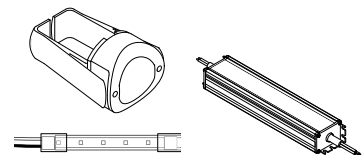

LED-BÄNDER /  
LED-SPOTLIGHTS

TRANSFORMATOREN

### PRODUKTGRUPPEN

Q-LIGHTS <b>SPOTLIGHT</b>	236	237
Q-LIGHTS <b>LINEAR LIGHT</b>	238, 245	239, 246



Schaffen Sie mit einer stilvollen Geländerbeleuchtung eine ganz besondere Atmosphäre und ein Plus an Sicherheit.

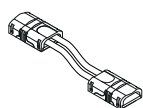

VERBINDER

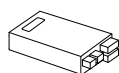

STEUERUNGSGERÄTE

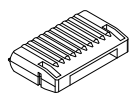

STROMVERSORGUNG

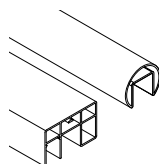

GLASLEISTENROHRE  
/ HANDLÄUFE

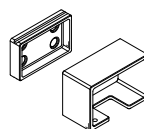

WANDFLANSCH

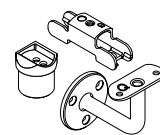

HANDLAUFSTÜTZEN  
/ -ADAPTER

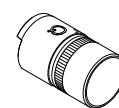

VERBINDER

			351	265	260-262	352-355
240-242, 247-251	252	252-253	254, 257, 259	254, 265	256, 258, 260-262	255, 263-264



# 4

## PFOSTENGELÄNDER-SYSTEME

266 - 421



EASY ALU



SQUARE LINE® 40x10

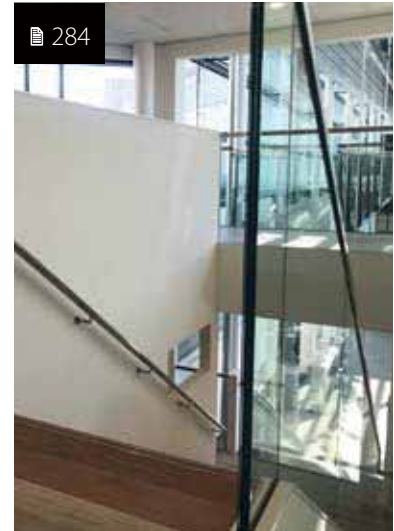

SQUARE LINE® 40x20



BARRIER LINE



Q-LINE HOCHGLANZPOLIERT



SCHWEIßTEILE



Verwenden Sie ein Pfostengeländersystem von Q-railing, um Ihrer Treppe, Ihrem Balkon oder Galerie einen besonderen Look zu verleihen. In unserem umfangreichen Sortiment finden Sie Lösungen für nahezu jede Montagesituation und Designanforderung.



288  
SQUARE LINE® 40x40



302  
SQUARE LINE® 60x30



308  
Q-LINE



384  
BENDYWOOD



386  
NATURAIL



388  
FÜLLUNGEN



# 4

## PFOSTENGELÄNDER-SYSTEME

266 - 421

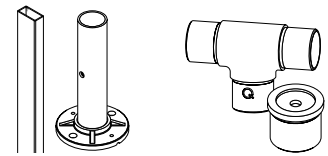

**A**

### GELÄNDERPFOSTEN

GELÄNDERPFOSTEN

VERBINDER / ADAPTER

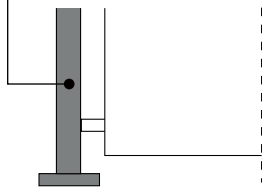

EASY ALU	270, 273	
SQUARE LINE® 40x40	290-291	296, 301
SQUARE LINE® 60x30	304	305
Q-LINE	310-314, 316, 320-322	332-333, 354, 356
BARRIER LINE	361	
Q-LINE HOCHGLANZPOLIERT	363	365, 368

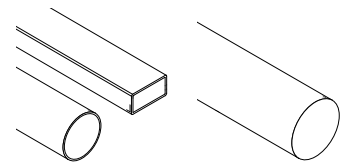

**B**

### HANDLÄUFE / WANDHANDLÄUFE

ROHRE

HOLZHANDLÄUFE

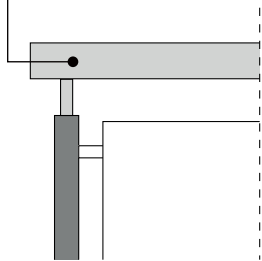

EASY ALU	275-276	
SQUARE LINE® 40x10	282	
SQUARE LINE® 40x20	285	
SQUARE LINE® 40x40	300	
SQUARE LINE® 60x30	305, 307	
Q-LINE	351	385-386
Q-LINE HOCHGLANZPOLIERT	367	
BENDYWOOD		385
NATURAIL		386

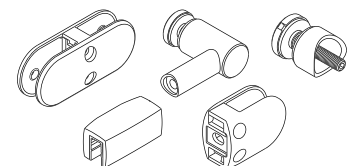

**C**

### FÜLLUNGEN

GLASBEFESTIGUNGEN

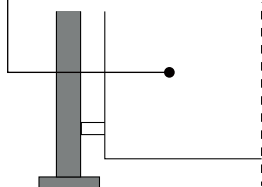

EASY ALU	
SQUARE LINE® 40x40	433-455
SQUARE LINE® 60x30	
Q-LINE	
Q-LINE HOCHGLANZPOLIERT	434-436, 440, 454-455



## SO FINDEN SIE GANZ EINFACH IHRE PRODUKTE

Unsere Geländersysteme bestehen in der Regel aus drei Segmenten: Geländerpfosten **A**, Handlauf **B** und Füllung **C**. Diese sind in verschiedene Produktgruppen unterteilt. Ermitteln Sie das Segment und die Produktgruppe - und finden Sie so auf Anhieb die gewünschten Artikel.

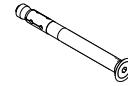
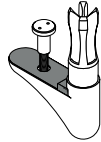
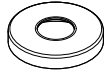
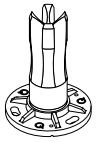
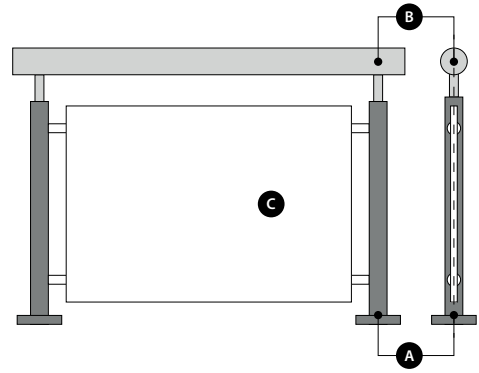

BODENFLANSCH

ABDECKKAPPEN

TREPPENFLANSCH

GELÄNDERPFOSTEN-  
HALTERUNGEN

SCHWEIßTEILE

BEFESTIGUNGS-  
MATERIAL

271	274		274		459-475
290, 292	290-292		293	374	
304	304-305		305	374	
310-312, 315-316	310-312, 315	322-323	317-319	373-374	
312	361				
			363		

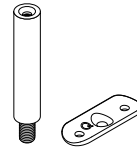
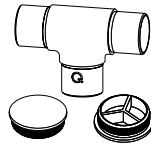
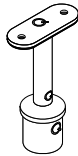
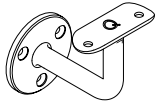

HANDLAUFSTÜTZEN

ROHRSTÜTZEN

VERBINDER /  
ENDSTÜCKE

WANDFLANSCH

HANDLAUF-  
STÜTZENTEILE

SCHWEIßTEILE

		277-279	278		375-381
282		283			
286-287		285	285		
297-299	294-295	300-301	301	296	
	306	305, 307	307	305	
338-349	324-326, 328-332, 349	352-358	359	329, 334-337	
365-366	364	367-368	368		
345-346, 349	324-326, 338, 349				
		387			

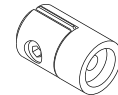
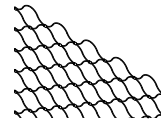
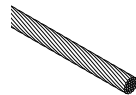
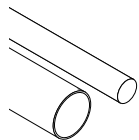
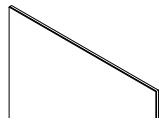
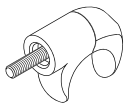

GLASRAHMENROHR

GLAS

STAB UND ROHR

DRAHTSEIL

NETZ

BLECHADAPTER

390-392	388-389	394-396, 398-399, 401, 403-405	407-413	415-416	419-421	
		394-395, 397-399, 403-405				
		369				370-371

## Easy Glass® Smart+

Suchen Sie nach einem schmalen Bodenprofil mit dem Sie auch Glasstärken bis zu 21,52 mm nicht nur problemlos installieren, sondern auch präzise ausrichten können? Dann gibt es mit Easy Glass® Smart+ jetzt die Lösung! Die neuen Bodenprofile beinhalten das justierbare Q-disc® System zur einfachen Glasmontage und -ausrichtung.

☰ 50

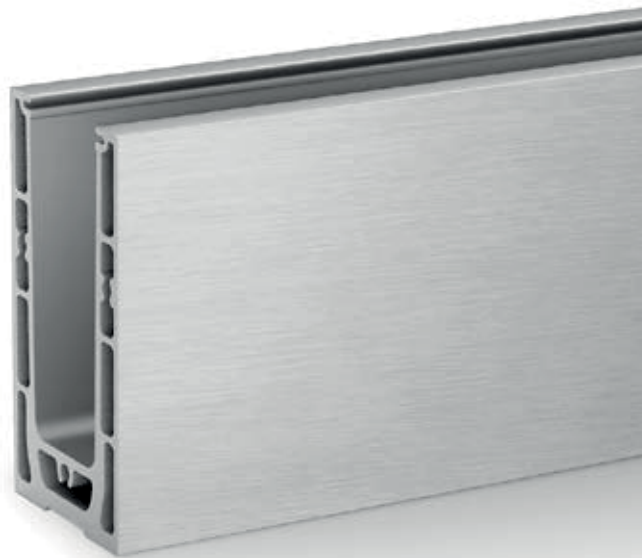

# NEU 2023



## Easy Glass® Strong

Ein extra starkes Bodenprofil plus Glasjustierung dank des innovativen Q-disc® Systems – das zeichnet das neue Glasgeländersystem Easy Glass® Strong aus. Die Kombination aus Kraft und Komfort macht es zu einer perfekten Lösung für Stadien, Flughäfen, Einkaufszentren und anderen öffentlichen Räumen.

☰ 82

## Optionen für **französische Balkone**

Entdecken Sie die Ergänzungen zum beliebten Easy Glass® View System. Mithilfe der neuen vorgebohrten Wand- und Mittelprofile können Sie französische Balkone noch schneller montieren. Neben den bekannten Systemen View und MOD 6507-6508 gibt es aber noch weitere Optionen: Schaffen Sie einen sicheren, dennoch eleganten Absturzschutz mit Glasklemmen, Glasadaptern, Absturzstangen oder Easy Alu Geländern.

☰ 188



# BLACK LINE



Das Black Line Sortiment bietet Ihnen eine breite Auswahl an schwarz pulverbeschichteten Komponenten für Pfosten- und Glasgeländer.



## Handlaufstützen

Entdecken Sie die neuen Handlaufstützen und weitere Einzelkomponenten in unseren Q-line und Square Line® Serien.

## Linear Light LED-Bänder und -Verbinder

Auch das Q-lights Linear Light Sortiment wurde erweitert – die neuen LED-Bänder, Verbinder und Transformatoren machen die Montage noch einfacher und vielseitiger. Da die neuen LED-Bänder mehr LED-Punkte pro Meter besitzen, schaffen Sie damit noch stimmungsvollere und sicherere Innenräume und Außenflächen. Fügen Sie Q-lights Linear Light oder Spotlight ganz einfach zu Ihrem gewünschten Q-railing Geländer hinzu.

238

### Farbige LED-Bänder

Sie brauchen einen Farbtupfer? Dann versehen Sie Ihre Glas- oder Pfostengeländer mit farbigen statt weißen LED-Bändern. Diese sind auf Anfrage bei uns erhältlich.



## Digitaler Katalog

Sie möchten eine digitale Version des Kataloges? Sie können den Katalog entweder direkt online durchblättern oder als PDF herunterladen und speichern: [www.q-railing.com](http://www.q-railing.com).

### Benötigen Sie Unterstützung?

Haben Sie Fragen, benötigen Sie eine Beratung oder möchten Sie ein Angebot erhalten? Wir helfen Ihnen gerne weiter. Senden Sie uns eine E-Mail oder rufen Sie uns an – wir sind für Sie da!

## QR-Codes für weitere Informationen

Scannen Sie die QR-Codes auf den Einführungsseiten der Systeme und gelangen Sie direkt zur jeweiligen Online-Systemseite mit weiteren Informationen: lassen Sie sich von Projektfotos inspirieren, sehen Sie sich Montagevideos und Installationshinweise an, laden Sie Testberichte oder CAD-Objekte herunter.

SCAN ME!





# UNSERE MATERIALIEN, FARBEN UND OBERFLÄCHEN



304

316

Edelstahl

Mit seiner Robustheit und der schönen Oberfläche ist Edelstahl eines der beliebtesten Materialien für Geländersysteme. Der Unterschied zwischen den verschiedenen Edelstahlsorten liegt in ihrer chemischen Zusammensetzung. Stahl korrodiert naturgemäß, aber verschiedene Elemente können ihm hinzugefügt werden, um ihn korrosionsbeständiger zu machen. Der Industriestandard für den Innenbereich ist Edelstahl V2A (304). Edelstahl V4A (316) enthält zusätzlich 2% Molybdän, was dazu führt, dass das Material widerstandsfähiger gegen Rissbildung, Lochfraß und Spannungsrisse ist. Daher empfehlen wir üblicherweise Edelstahl V4A (316) für den Einsatz im Außenbereich.



Kunststoff

Das von uns verwendete thermoplastische Material verfügt über eine hervorragende chemische Beständigkeit und Belastbarkeit. Unsere Kunststoff-Abdeckkappen und -Blendstopfen sind in den passenden Farben zu den dazugehörigen Edelstahl-, Aluminium- und Zinkdruckguss-Produkten erhältlich. Das Material gewährt eine ausgewogene Beständigkeit gegen Stöße, Hitze, chemische Einflüsse und Abrieb. Außerdem bietet es Dimensionsstabilität, Zugfestigkeit, Oberflächenhärte, Steifigkeit und gute elektrische Eigenschaften.



Aluminium

Aluminium ist leicht und gleichzeitig sehr robust und widerstandsfähig. Es hat eine natürlich auftretende Oxidschicht, die das Metall vor Korrosion schützt. Diese Schicht kann weiter verstärkt werden, um einen noch höheren Schutz zu bieten. Die meisten Aluminium-Produkte in diesem Katalog haben daher einen Anodisierungsprozess durchlaufen (25µ). Ist dies nicht der Fall, sprechen wir von Aluminium, roh.

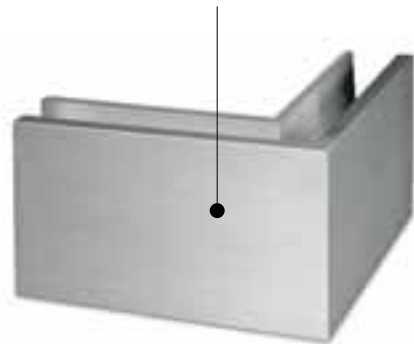

Zinkdruckguss

Zinkdruckgusserzeugnisse sind robust und preiswert, und daher eine kostengünstige Alternative zu anderen Metallen. Um dem Material eine attraktive Oberfläche zu verleihen, können Sie es mit einer Lackierung oder einer Beschichtung versehen. Viele der Zinkdruckgussprodukte von Q-railing sind bereits PVD- oder pulverbeschichtet und einbaufähig.















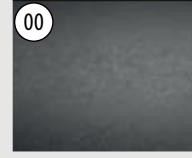
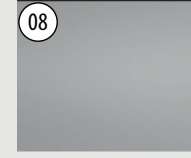

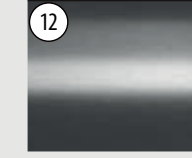







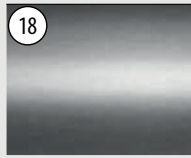

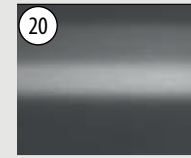
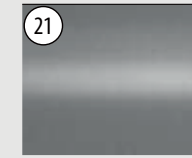
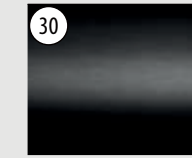



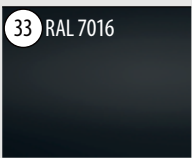

Stahl

Stahl gibt es in verschiedenen Legierungen, die jeweils für unterschiedliche Zwecke geeignet sind. Seine Stärke und Festigkeit hängen von der Kombination aus Eisen, Kohlenstoff und weiteren Zugaben ab. Stahl wertet Ihre Projekte auf, vor allem wenn die Komponenten passend zum gewünschten Farbschema pulverbeschichtet werden.

Unsere verfügbaren Farben und Oberflächenausführungen sind unten dargestellt. Bei den meisten Artikelnummern verweisen die letzten beiden Ziffern auf die entsprechende Farbe und/oder Oberfläche.

158238-36  
 133507-033-12  
 168410-050-00-82

Verfügbare Farben/Oberflächen

 00 Roh	 00 Roh	 00 Roh	 08 Mattsilbereffekt	 10 Hochglanzpoliert	 12 Gebürstet
					
 17 Glanzverchromt	 18 Gebürstet, anodisiert	 19 Edstahleffekt	 20 Edstahleffekt	 21 Edstahleffekt	 30 KTL-beschichtet*
					
 33 RAL 7016 Anthrazitgrau, matt, glatt	 36 RAL 9006 Weißaluminium, satiniert, glatt	 80 RAL 9005 Schwarz, satiniert, strukturiert	<p><b>Verfügbar für</b></p> <ul style="list-style-type: none"> <li> Edelstahl</li> <li> Aluminium</li> <li> Zinkdruckguss</li> <li> Stahl</li> <li> Kunststoff</li> </ul>		<p>*E-coat (KTL), auch elektrophoretische Beschichtung genannt, ist eine dünne Schicht (15 µ), die Stahlprodukten einen Schutzfilm (Grundierung) verleiht. Nach der E-Beschichtung ist das Produkt bereit für die finale Oberflächenbehandlung, beispielsweise eine Lackierung oder eine Pulverbeschichtung.</p>
					

## Pulverbeschichtet

 32 RAL 9016 Weiß, satiniert, glatt	 33 RAL 7016 Anthrazitgrau, matt, strukturiert	 34 RAL 7047 Telegrau 4, satiniert, glatt	 82 RAL 9005 Schwarz, matt, strukturiert	 89 RAL 9005 Schwarz, matt, glatt
				

Alle rohen/unbehandelten Komponenten, die auf -00 enden, können in jeder RAL-Farbe pulverbeschichtet werden.



# SETZEN SIE AKZENTE

ERHÄLTlich IN VERSCHIEDENEN OBERFLÄCHENAUSFÜHRUNGEN

Black Line umfasst ein vielfältiges Sortiment aus tiefschwarzen RAL 9005 Geländerkomponenten. Damit finden Sie immer die passende Lösung für Ihr nächstes Geländerprojekt – egal ob Glasklemmen, Glasadapter, Bodenprofile, Geländerpfosten oder Handläufe. Die aus hochwertigen Materialien hergestellten und perfekt verarbeiteten Komponenten sind so entwickelt, dass Sie sie leicht zusammenbauen und montieren können.





# Reinigung und Pflege



Edelstahl ist aufgrund seiner Zusammensetzung äußerst korrosions- und kratzfest. Dennoch sollte er regelmäßig gepflegt werden, insbesondere bei extremen Umwelteinflüssen. Wir empfehlen die komplette Oberfläche nach der Montage mit Q-ultra-clean zu behandeln. Dies hilft eine starke Passivschicht, dauerhaften Schutz und ein langanhaltendes, gutes Aussehen zu gewährleisten.

Verwendung	
Q-protector	Edelstahl + Aluminium
Q-ultra-clean	Edelstahl
Q-cleaner	Edelstahl (+ Aluminium)

## Q-protector

Verwenden Sie dieses Langzeit-Schutzspray direkt nach der Montage Ihrer Edelstahl- oder Aluminiumgeländer. Es entfernt nicht nur Staub und Montagereste, sondern schützt das Geländer gleichzeitig – durch die Bildung einer Schutzschicht – auch vor Fingerabdrücken, Feuchtigkeit und Witterungseinflüssen. Und das Beste: die Komponenten müssen nach der Einwirkzeit nicht mit Wasser abgespült werden. Unser Q-protector sorgt für eine längere Lebensdauer Ihrer Edelstahl- oder Aluminiumgeländer und minimiert die Reinigungsintervalle.

## Q-ultra-clean

Dieses Reinigungsspray wurde speziell für Edelstahl-Komponenten entwickelt. Es sollte direkt nach der Montage, präventiv oder bei auftretender Korrosion verwendet werden, da es hartnäckigen Schmutz und Oberflächenkorrosion entfernt. Es erneuert und stärkt außerdem die Schutz-/Passivschicht des Edelstahls.

## Q-cleaner

Q-cleaner hat eine entöhlende Wirkung und entfernt Flecken, Fingerabdrücke und Permanentmarker. Er ist ideal für den Einsatz während der Montage sowie als regelmäßiger Reiniger zur Pflege des Geländers.

Andere Materialien, die für unsere Produkte verwendet werden – zum Beispiel Stahl und Zink – können mit warmem Seifenwasser gereinigt werden.

# Anwendungsgebiete

Umgebungseinflüsse	Anwendung	Zinkdruckguss	Aluminium (gebürstet)	Aluminium (roh)	Aluminium (pulverbeschichtet)	Edelstahl (V2A)	Edelstahl (V4A)
						304	316
Niedrig	Innenbereich Nicht in Feuchträumen.	✓	✓	✓	✓	✓	✓
Moderat	Innenbereich Nicht an Orten mit nennenswerter Belastung durch Chlor- oder Schwefeldioxid (z. B. Chemiefabriken)	✓	✓	✓	✓	✓	✓
Medium	Außenbereich Orte mit mäßiger Chlor- und Schwefeldioxidbelastung (z.B. Binnenland, mindestens 25 km Entfernung zur Küste oder anderen wasserreichen Umgebungen)	!	✓	✗	✗	✗	✓
Hoch	Außenanwendung Orte mit einem hohen Grad an Korrosionsbildung durch Chlor- und/oder Schwefeldioxidbelastung, hoher Luftfeuchtigkeit oder einer Ansammlung schädlicher Substanzen (z. B. in Küstenregionen oder in direkter Umgebung von Swimmingpools).	✗	✓	✗	✗	✗	✓ 

✓ = Geeignet

! = Geeignet, erfordert aber besondere Aufmerksamkeit/Beratung

✗ = Nicht geeignet



**Jetzt  
registrieren**

# MEHR ALS NUR EIN ONLINESHOP

Profitieren Sie vom Q-railing Onlineshop: Bestellen Sie all unsere Produkte, inklusive aller Geländersysteme und Einzelkomponenten aus diesem Katalog sowie weitere Artikel, rund um die Uhr online. Zudem finden Sie im Onlineshop Informationen wie aktuelle Lagerbestände, Preisaktionen und persönlichen Rabatte.

## Highlights des Q-railing Onlineshops:

- ✓ Online bestellen
- ✓ Angebote anfragen
- ✓ Lagerbestand ansehen
- ✓ Produktinformationen erhalten
- ✓ Persönliche Rabatte einsehen
- ✓ Aktuelle Preise und Preisaktionen entdecken

### Sind Sie bereits Q-railing Kunde?

Registrieren Sie sich ganz einfach online und erhalten Sie Ihre persönlichen Login-Informationen von unserem Verkaufsteam.

### Noch kein Q-railing Kunde?

Kein Problem – registrieren Sie sich online als Neukunde. Nach der Bestätigung durch unser Verkaufsteam erhalten Sie vollen Zugang zum Onlineshop und allen Funktionen.

# PREFIX MACHT DAS LEBEN LEICHTER

Eine perfekte Vorbereitung ist der Schlüssel zum Erfolg. Nutzen Sie daher unseren zeit- und kostensparenden Vorfertigungsservice beim Kauf Ihrer Geländerlösung von Q-railing. Sie erhalten alles zu 100% montagefertig.

**PREFIX** Prefix-Optionen verfügbar.

**Biegen**  
Wir bieten 2D- und 3D-Biegearbeiten an Rohren, Glasleistenrohren, U-Profilen, Kantenschutzprofilen und sogar Easy Glass® Bodenprofilen an. Unser akkurater Service stellt sicher, dass Sie genau die Größen und Radien erhalten, die Sie benötigen.

**Zuschneiden und Fräsen**  
Maximalen Komfort bietet auch unser Zuschnittservice für Elemente aus Edelstahl, Aluminium und Holz. Dies umfasst Handläufe, Glasleistenrohre, Pfosten und Easy Glass® Bodenprofile. Wir können Ihre Produkte zudem auf Gehrung zuschneiden oder mit vorgefrästen Löchern, z.B. für LED-Spotlights, liefern.

**Bohren und Gewindeschneiden**  
Überlassen Sie uns alle notwendigen Bohrarbeiten: Nach Ihren genauen Vorgaben versehen wir Pfosten und andere Geländerelemente mit sämtlichen Löchern und Gewinden, die Sie für die Installation benötigen.

**Schweißen**  
In seltenen Fällen müssen die Standardprodukte von Q-railing geschweißt werden, um eine bestimmte Einbausituation zu erfüllen. Gerne schweißen wir Ihre maßgefertigten Produkte vor und liefern sie montagefertig an.

**Pulverbeschichtung**  
Lassen Sie Bodenprofile, Glasleistenrohre, Endkappen oder andere Geländerkomponenten in der RAL-Farbe Ihrer Wahl pulverbeschichten. Geben Sie dies einfach bei Ihrer Bestellung an und wir liefern die gewünschten Artikel farblich passend für Ihr Geländerprojekt.

**Vormontage**  
Nutzen Sie einfach unseren Prefix-Service, um Q-railing Produkte nach Ihren Wünschen vormontieren zu lassen. Erleben Sie, wie viel Zeit Sie sparen können, wenn z. B. Glasklemmen oder Querstabhalter bereits vorinstalliert sind.

**Nutzen Sie die Online-Formulare, um unseren Vorfertigungsservice zu nutzen. Oder sprechen Sie uns an - wir helfen Ihnen gerne weiter.**

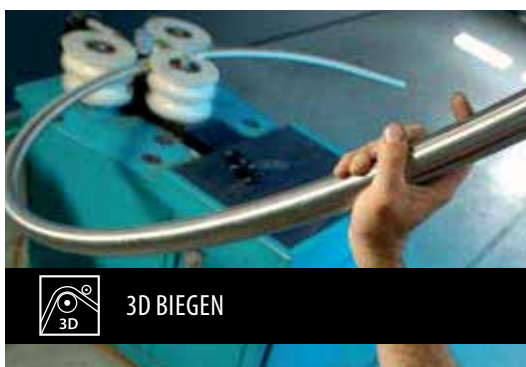







1

# GANZGLAS- GELÄNDER- SYSTEME

Easy Glass® Smart	28 - 49
Easy Glass® Smart+	50 - 61
Easy Glass® Prime	62 - 81
Easy Glass® Strong	82 - 93
Easy Glass® Slim	94 - 103
Easy Glass® Pro	104 - 115
Easy Glass® Max	116 - 125
Easy Glass® Up	126 - 133
Easy Glass® Hybrid	134 - 139
Easy Glass® Bodenglasklemmen	140 - 145
Easy Glass® Air	146 - 149
Easy Glass® Glasadapter	150 - 164



**Beanspruchung:** Leicht und mittel  
**Verwendung:** Innen- und Außenbereich  
**Montage:** Boden-, In-Boden- und Seitenmontage  
**Anwendung:** Balkone, Galerien, Wege, Abtrennungen, Treppen und französische Balkone  
**Material:** Aluminium (gebürstet anodisiert, roh und pulverbeschichtet in RAL 9005 schwarz)  
**Glasstärke:** 12 bis 21,52 mm

Finden Sie alle Informationen zu Easy Glass Smart online:



<https://q-ne.ws/Smart23>

# EASY GLASS<sup>®</sup> SMART



red dot winner 2020  
innovative product



# Unschlagbar einfache Installation

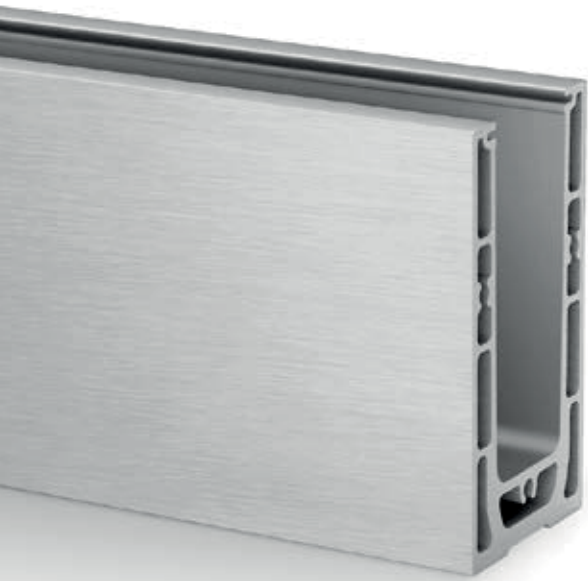

Easy Glass® Smart beinhaltet das revolutionäre Q-disc® System. Die Kombination aus Inlay und Q-disc ermöglicht eine extrem schnelle Glasmontage. Installieren Sie das Bodenprofil, positionieren Sie das Glas und fixieren Sie anschließend mit nur einer einzigen Handbewegung jede Scheibe sicher im Profil. Mit der justierbaren Variante des Q-disc Systems können Sie zudem jede einzelne Glasscheibe in der Vertikalen ausrichten. Ein zusätzliches Feature sind die Easy Glass Bauanschlussleisten für eine nahtlose Verbindung mit dem angrenzenden Boden. Diese sorgen für ein stilvolles Finish und einen erhöhten Materialschutz.

## Easy Glass® Smart

Max. Holmlast (kN/m)

DE

1,0

STATISCHE  
BERECHNUNG  
DIN18008

AbP  
BALAST  
GEPRÜFT

Bitte beachten Sie die Spezifikationen wie Befestigungs- und Glasmaße sowie Glastypen der jeweiligen Zertifikate.

## International getestet/berechnet/zertifiziert:



- 1 Mit dem justierbaren Q-disc System können Sie die Glasfüllung nicht nur fixieren, sondern auch um 0,6° in der Vertikalen ausrichten.
- 2 Mit einem Klickgeräusch signalisiert die Q-disc die korrekte Installation.
- 3 Geeignet für Glasstärken zwischen 12 und 21,52 mm.

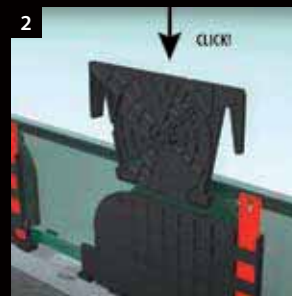
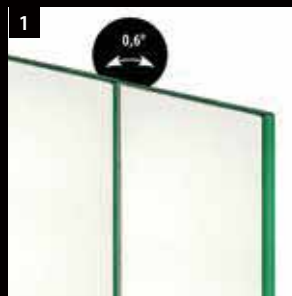

## EASY GLASS® SMART MONTAGEOPTIONEN

### Smart

Bodenmontage

- Auch für die In-Bodenmontage

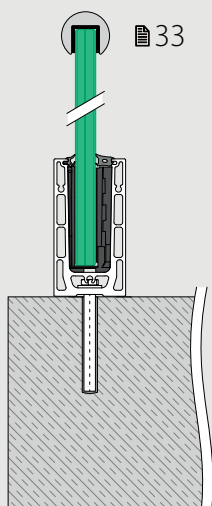

### Smart F

Bodenmontage

- Für Rohfußböden
- Kann direkt an oder über der Bodenkante angebracht werden

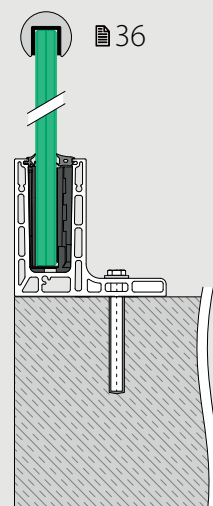

### Smart

Seitenmontage

- Auch zur Montage an der Innenseite von Aufmauerungen
- Bodenprofil-Blendeleiste erhältlich

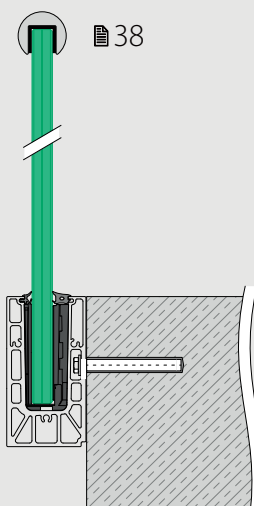

### Smart Y

Seitenmontage

- Für Rohfußböden
- Kann direkt an oder über der Bodenkante angebracht werden
- Bodenprofil-Blendeleiste erhältlich

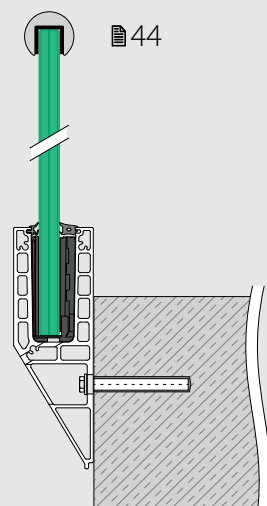



# JUSTIERBARES Q-DISC® SYSTEM SCHIEBEN UND AUSRICHTEN!



## SO FUNKTIONIERT'S

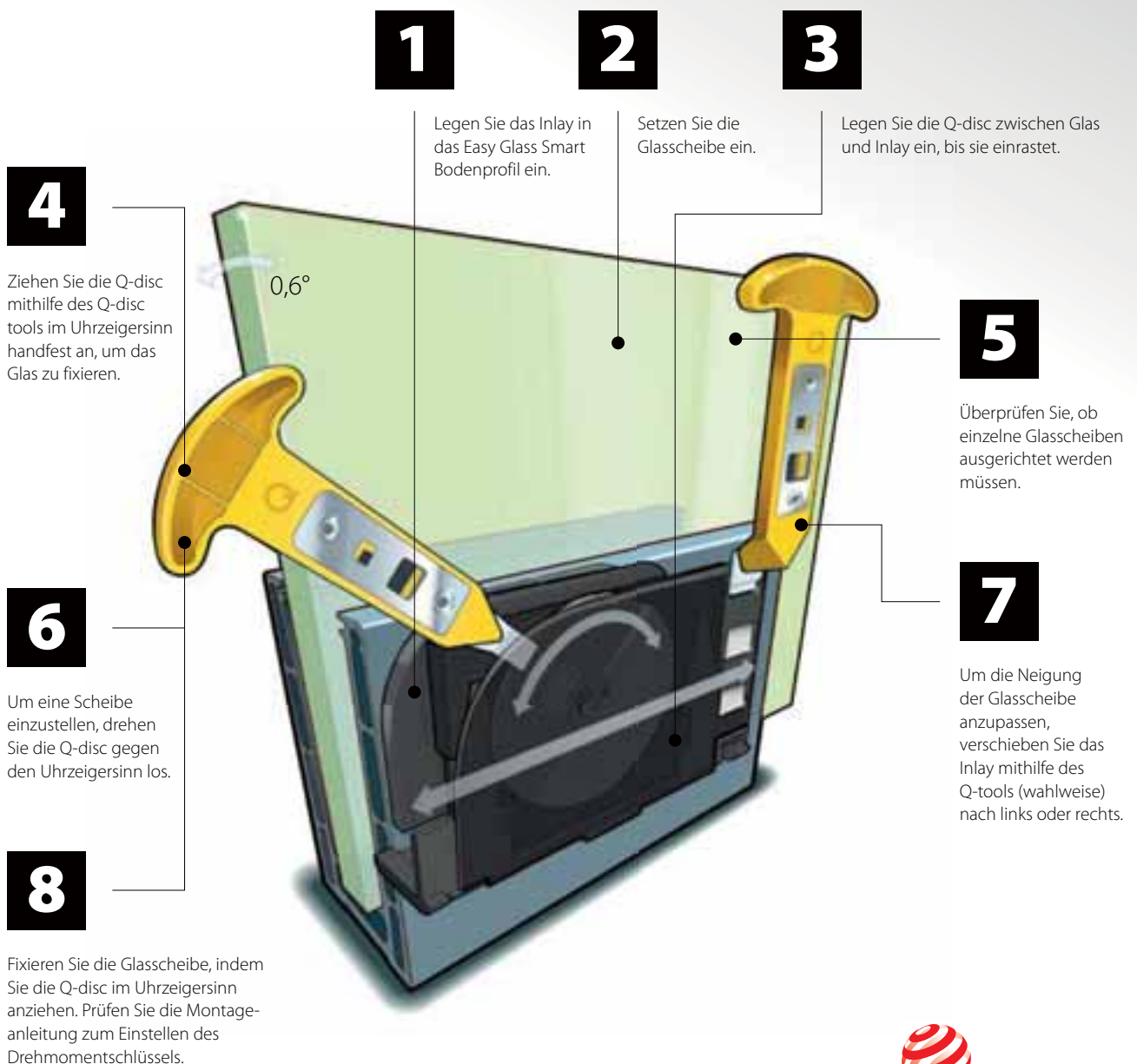

reddot winner 2020  
innovative product

Q-disc® System (Gummi, Inlay und Q-disc®)

Glasklemmung und -justierung

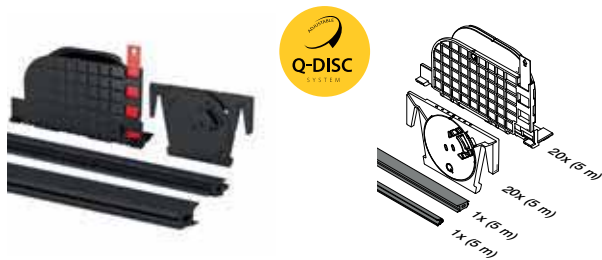

MOD 8201

Zubehör		
Für monolithisches Glas	T	
208201-050-12	12	L = 5 m
208201-050-15	15	L = 5 m
208201-250-12	12	L = 25 m
208201-250-15	15	L = 25 m
Für laminiertes Glas		
208201-050-13	12,76	L = 5 m
208201-050-14	13,52	L = 5 m
208201-050-17	16,76	L = 5 m
208201-050-18	17,52	L = 5 m
208201-250-13	12,76	L = 25 m
208201-250-14	13,52	L = 25 m
208201-250-17	16,76	L = 25 m
208201-250-18	17,52	L = 25 m



Internationaler Geschmacksmusterschutz

Einzelne Gummis

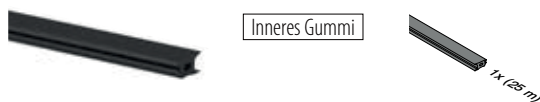

MOD 8207

Zubehör	
208207-250-00	L = 25 m



MOD 8207

Zubehör		
Für monolithisches Glas	T	
208207-250-12	12	L = 25 m
208207-250-15	15	L = 25 m

Für laminiertes Glas

208207-250-14	12,76 - 13,52	L = 25 m
208207-250-18	16,76 - 17,52	L = 25 m



Q-disc®-Sets

Glasklemmung und -justierung

Q-disc®- und Inlay-Werkzeug



MOD 1000

Zubehör		
	Q	
201000	Q-84	1

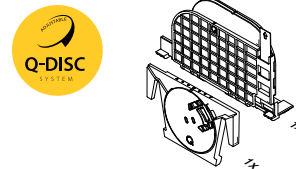

MOD 8209

Zubehör		
Für monolithisches Glas	T	
208209-12	12	5
208209-15	15	5

Für laminiertes Glas

208209-13	12,76	5
208209-14	13,52	5
208209-17	16,76	5
208209-18	17,52	5



**Q-INFO** MOD 1000

Q-INFO

Installationsblech  
**MOD 1002**  
  
 482

Geländerbasis

Q-disc® System (Gummi, Inlay und Q-disc®)

Glasklemmung (nicht justierbar)

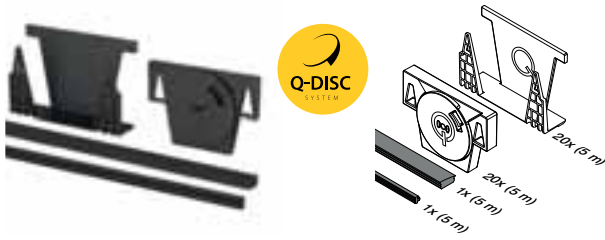

MOD 8200

Zubehör

Für monolithisches Glas		
	T	
SELL OUT 208200-050-12	12	L = 5 m
SELL OUT 208200-050-15	15	L = 5 m
SELL OUT 208200-050-19	19	L = 5 m

Für laminiertes Glas

SELL OUT 208200-050-13	12,76 - 13,52	L = 5 m
SELL OUT 208200-050-17	16,76 - 17,52	L = 5 m
SELL OUT 208200-050-21	20,76 - 21,52	L = 5 m

SELL OUT 208200-250-13	12,76 - 13,52	L = 25 m
SELL OUT 208200-250-17	16,76 - 17,52	L = 25 m
SELL OUT 208200-250-21	20,76 - 21,52	L = 25 m



Internationaler Geschmacksmusterschutz

Zubehör

Q-disc®- und Inlay-Werkzeug



MOD 1000

Zubehör

	Q	
201000	Q-84	1

Nur solange der Vorrat reicht.

Zubehör

Einzelne Gummis



MOD 8206

Zubehör

208206-250-00		L = 25 m
---------------	--	----------

NEW



MOD 8206

Zubehör

Für laminiertes Glas		
	T	
208206-250-13	12,76 - 13,52	L = 25 m
208206-250-17	16,76 - 17,52	L = 25 m
208206-250-21	20,76 - 21,52	L = 25 m

NEW

Zubehör

Q-disc®-Sets

Glasklemmung (nicht justierbar)



MOD 8208

Zubehör

Für monolithisches Glas		
	T	
208208-12	12	5
208208-15	15	5
208208-19	19	5

Für laminiertes Glas

208208-13	12,76 - 13,52	5
208208-17	16,76 - 17,52	5
208208-21	20,76 - 21,52	5

NEW



Q-INFO | MOD 1000





Bodenprofile zur Bodenmontage

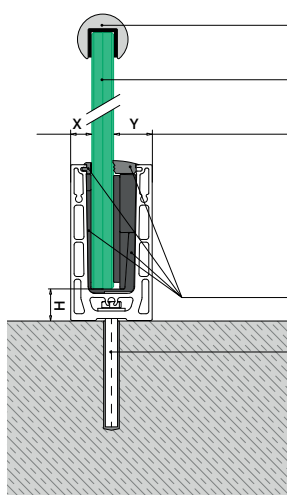

Glasleistenrohre: ■ 169 - 185  
 Kantenschutz: ■ 166 - 168  
 VSG aus ESG: ■ 160 - 161  
 Glasklemmung und -justierung  
 X = variabel X = 15  
 Y = 25,5 Y = variabel  
 H = 25 H = 23  
 Q-disc® System: ■ 31, 32  
 Anker: ■ 459 - 465

Bitte beachten Sie die Spezifikationen wie Befestigungs- und Glasmaße sowie Glastypen der jeweiligen Zertifikate und statischen Berechnungen.

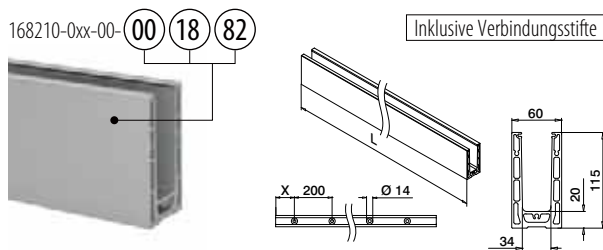

MOD 8210

<b>Aluminium</b>	Roh		
	<b>X</b>		
168210-050-00-00	100	■ 459 - 465	L = 5 m
<b>Aluminium</b>	Gebürstet		
<b>OUTDOOR</b>			
168210-025-00-18	50	■ 459 - 465	L = 2,5 m
168210-050-00-18	100	■ 459 - 465	L = 5 m
<b>Aluminium</b>	Black Line		
<b>OUTDOOR</b>			
<b>NEW</b>	168210-050-00-82	100	■ 459 - 465 L = 5 m



Internationaler Geschmacksusterschutz

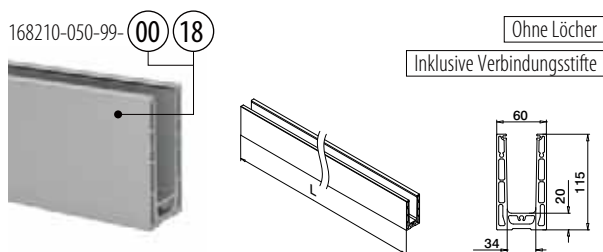

MOD 8210

<b>Aluminium</b>	Roh	
168210-050-99-00		L = 5 m
<b>Aluminium</b>	Gebürstet	
<b>OUTDOOR</b>		
168210-050-99-18		L = 5 m



Internationaler Geschmacksusterschutz

Q-INFO

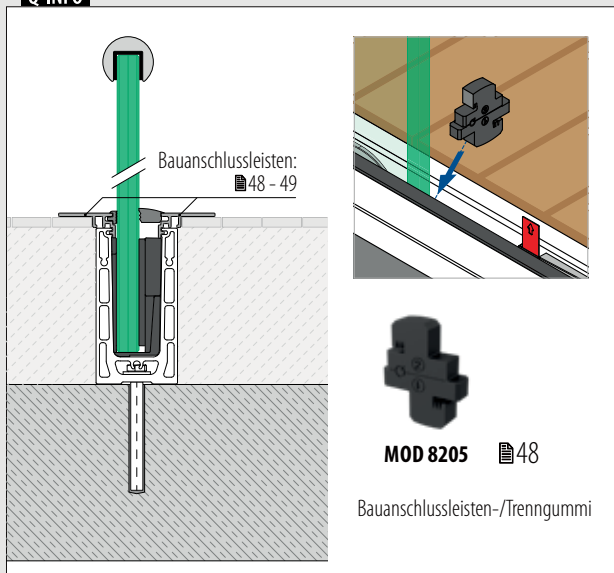

Q-INFO

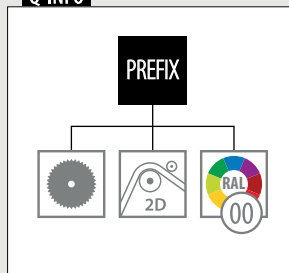

Q-INFO



Q-INFO Aluminium



Geländerbasis

Ecken zur Bodenmontage

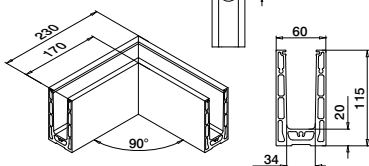

MOD 8211

<b>Aluminium</b>	Roh		
168211-00-00		459 - 465	1
<b>Aluminium</b>	Gebürstet		
<b>OUTDOOR</b>			
168211-00-18		459 - 465	1
<b>Aluminium</b>	Black Line		
<b>OUTDOOR</b>			
<b>NEW</b> 168211-00-82		459 - 465	1



Internationaler Geschmacksmusterschutz

Geländerbasis

Endkappen zur Bodenmontage



Links / rechts

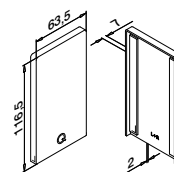

MOD 8212

<b>Aluminium</b>	Roh	<b>Klebeband</b>	
168212-00-00		Beigelegt	1
<b>Aluminium</b>	Gebürstet		
<b>OUTDOOR</b>			
168212-00-18		Angebracht	1
<b>Aluminium</b>	Black Line		
<b>OUTDOOR</b>			
<b>NEW</b> 168212-00-82		Beigelegt	1

Q-INFO MOD 8212

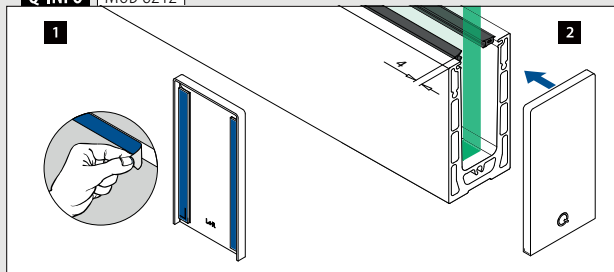

Q-INFO Aluminium



## Endkappen zur Bodenmontage

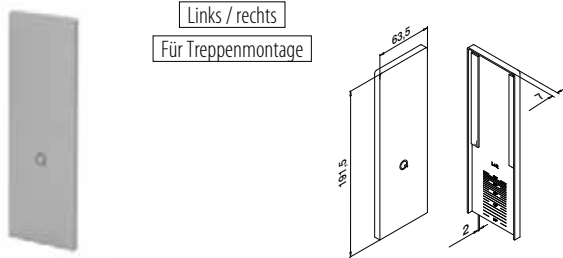

## MOD 8213

<b>Aluminium</b>	Roh		
		<b>Klebeband</b>	
168213-00-00	Beigelegt		1
<b>Aluminium</b>	Gebürstet		
		<b>OUTDOOR</b>	
168213-00-18	Angebracht		1



## Unterlegscheiben zur Bodenmontage

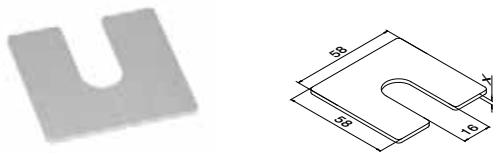

## MOD 8216

<b>Aluminium</b>	Roh	<b>X</b>	
168216-001	1		100
168216-002	2		100
168216-003	3		100

## Drainageleisten zur Bodenmontage

4 Stück für 2,5-Meter-Bodenprofil  
8 Stück für 5-Meter-Bodenprofil

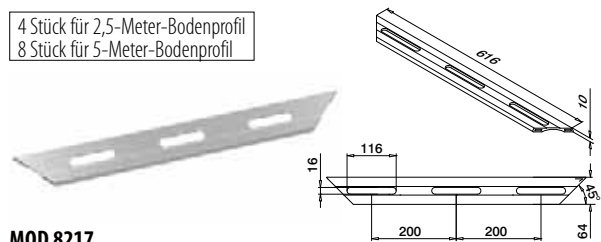

## MOD 8217

<b>Aluminium</b>	Gebürstet		
		<b>OUTDOOR</b>	
168217-18			4

## Q-INFO MOD 8213

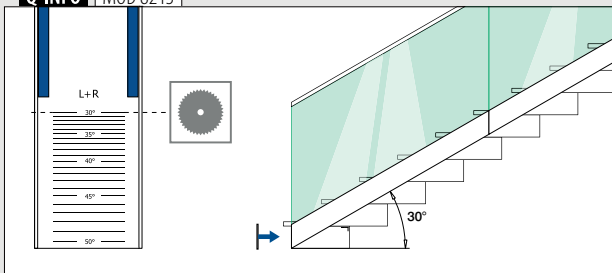

## Q-INFO MOD 8216

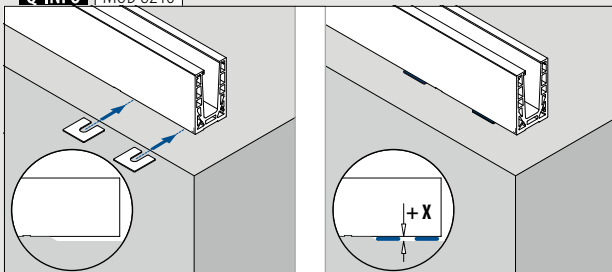

## Q-INFO MOD 8217

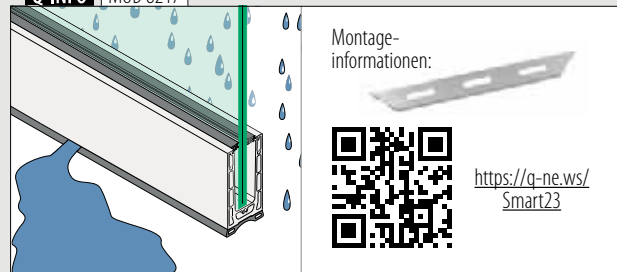

**Bodenprofile zur Bodenmontage**

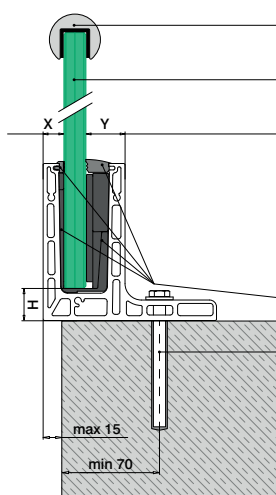

Glasleistenrohre: ■ 169 - 185  
Kantenschutz: ■ 166 - 168

VSG aus ESG: ■ 160 - 161

Glaskehlung und -justierung  
X = variabel  
Y = 25,5  
H = 25

Zur nicht justierbaren Glaskehlung  
X = 15,5  
Y = variabel  
H = 23

Q-disc® System: ■ 31, 32

Anker: ■ 459 - 465

Bitte beachten Sie die Spezifikationen wie Befestigungs- und Glasmaße sowie Glastypeen der jeweiligen Zertifikate und statischen Berechnungen.

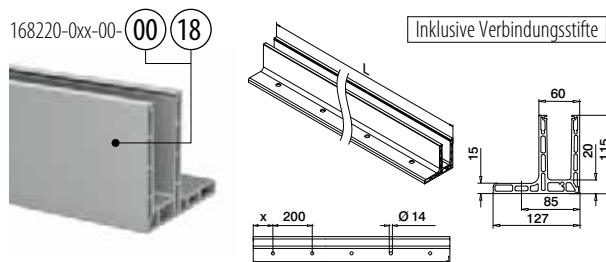

**MOD 8220**

<b>Aluminium</b>	Roh		
	<b>X</b>		
168220-050-00-00	100	■ 459 - 465	L = 5 m
<b>Aluminium</b>	Gebürstet		
<b>OUTDOOR</b>			
168220-025-00-18	50	■ 459 - 465	L = 2,5 m
168220-050-00-18	100	■ 459 - 465	L = 5 m



Internationaler Geschmacksmusterschutz

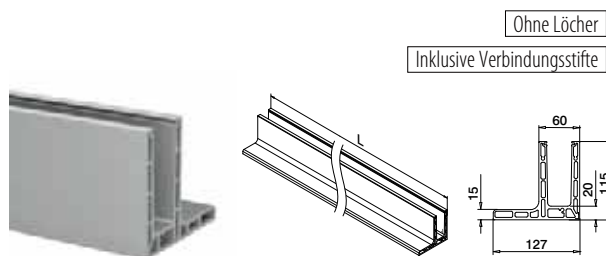

**MOD 8220**

<b>Aluminium</b>	Gebürstet		
168220-050-99-18			L = 5 m



Internationaler Geschmacksmusterschutz

**Q-INFO**

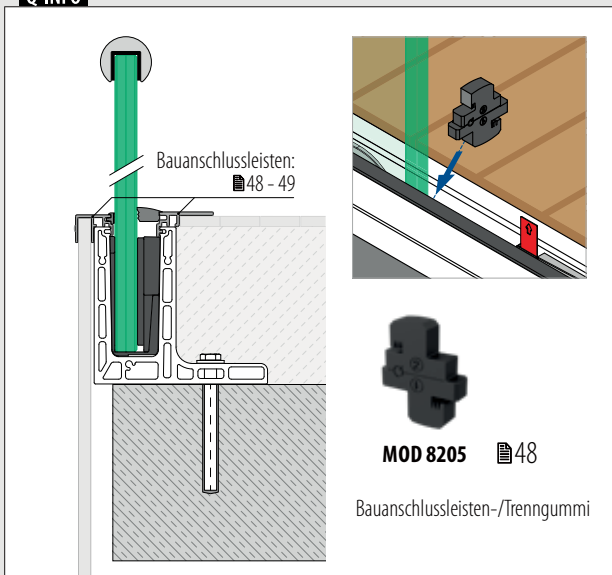

**Q-INFO**

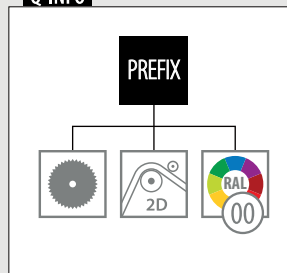

**Q-INFO Aluminium**



**Q-INFO**





Ecken zur Bodenmontage

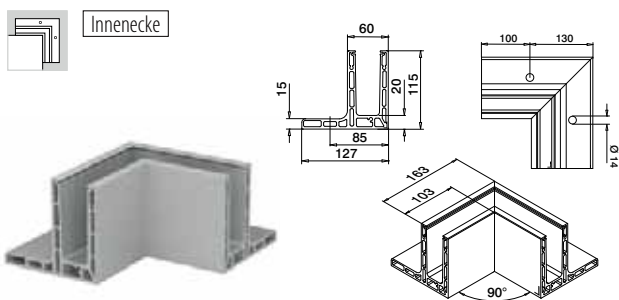

MOD 8221

<b>Aluminium</b>	Gebürstet		
<b>OUTDOOR</b>			
168221-01-18	459 - 465		1



Internationaler Geschmacksmusterschutz

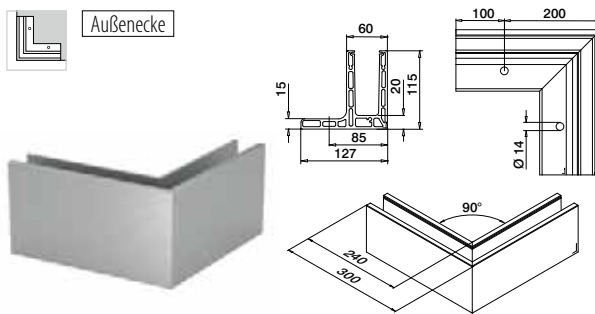

MOD 8221

<b>Aluminium</b>	Gebürstet		
<b>OUTDOOR</b>			
168221-02-18	459 - 465		1



Internationaler Geschmacksmusterschutz

Endkappen zur Bodenmontage

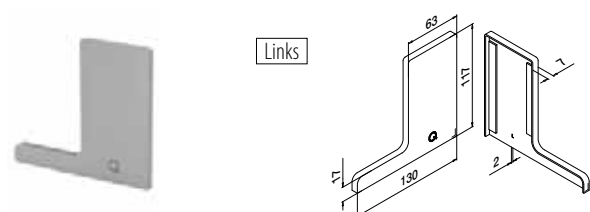

MOD 8222

<b>Aluminium</b>	Roh		
<b>Klebeband</b>			
168222-01-00	Beigelegt		1
<b>Aluminium</b>	Gebürstet		
<b>OUTDOOR</b>			
168222-01-18	Angebracht		1

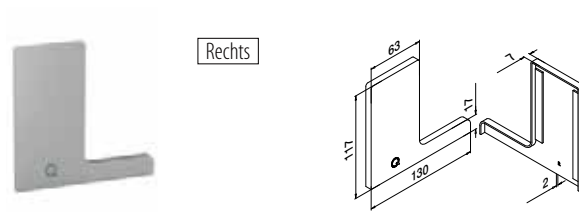

MOD 8222

<b>Aluminium</b>	Roh		
<b>Klebeband</b>			
168222-02-00	Beigelegt		1
<b>Aluminium</b>	Gebürstet		
<b>OUTDOOR</b>			
168222-02-18	Angebracht		1

Wasserdichte Verkleidungen

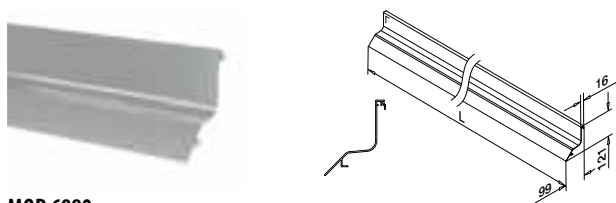

MOD 6980

<b>Aluminium</b>	Roh		
<b>Klebeband</b>			
166980-50-00	Nicht inkl.*		1
<b>Aluminium</b>	Gebürstet		
<b>OUTDOOR</b>			
166980-50-18	Nicht inkl.*		1



\*Bestellen Sie MOD 1360 (Klebeband)

Acrylat-Klebeband



MOD 1360

<b>Zubehör</b>				
201360	Q-53	9	33 m	1

Q-INFO MOD 8222

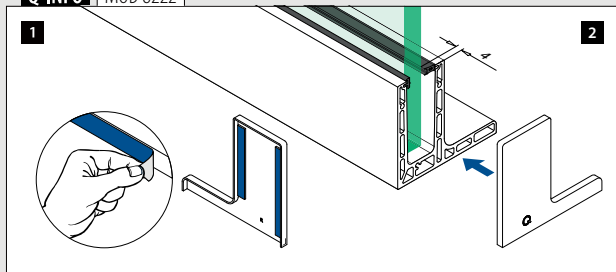

Q-INFO MOD 6980

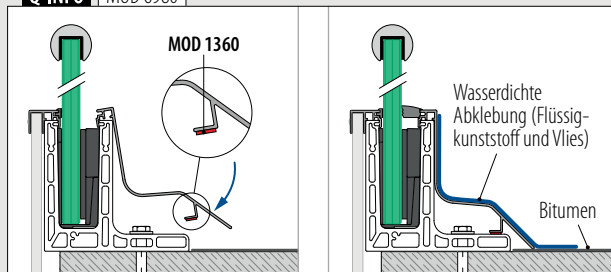

Geländerbasis

Bodenprofile zur Seitenmontage

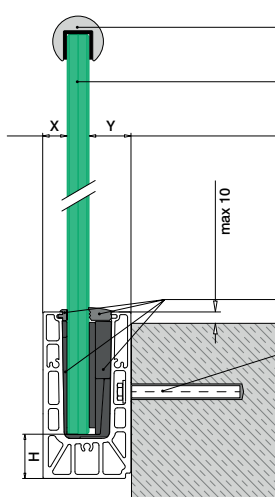

Glasleistenrohre: ■ 169 - 185  
Kantenschutz: ■ 166 - 168

VSG aus ESG: ■ 160 - 161

Glaskehlung und -justierung  
X = variabel  
Y = 28,5  
H = 35

Zur nicht justierbaren Glaskehlung  
X = 18,5  
Y = variabel  
H = 33

Q-disc® System: ■ 31, 32

Anker: ■ 459 - 465

Bitte beachten Sie die Spezifikationen wie Befestigungs- und Glasmaße sowie Glastypeen der jeweiligen Zertifikate und statischen Berechnungen.

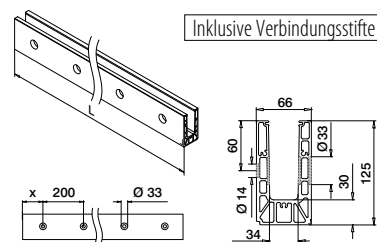

Inklusive Verbindungsstifte

MOD 8230

Aluminium	Roh	X		
168230-050-00-00	100	■ 459 - 465		L = 5 m
Aluminium	Gebürstet			
OUTDOOR				
168230-025-00-18	50	■ 459 - 465		L = 2,5 m
168230-050-00-18	100	■ 459 - 465		L = 5 m



Internationaler Geschmacksmusterschutz

Geländerbasis

Ecken zur Seitenmontage

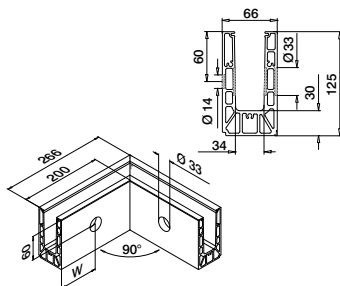

MOD 8231

Aluminium	Roh	W		
168231-01-00	100*	■ 459 - 465		1
Aluminium	Gebürstet			
OUTDOOR				
168231-01-18	100*	■ 459 - 465		1



Internationaler Geschmacksmusterschutz

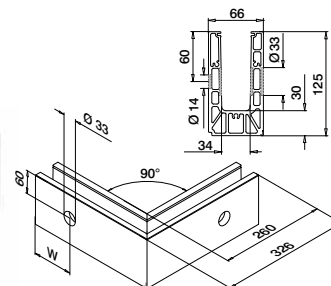

MOD 8231

Aluminium	Roh	W		
168231-02-00	100*	■ 459 - 465		1
Aluminium	Gebürstet			
OUTDOOR				
168231-02-18	100*	■ 459 - 465		1



Internationaler Geschmacksmusterschutz

\*Die Lochposition kann produktionsbedingt abweichen.

Q-INFO MOD 8230

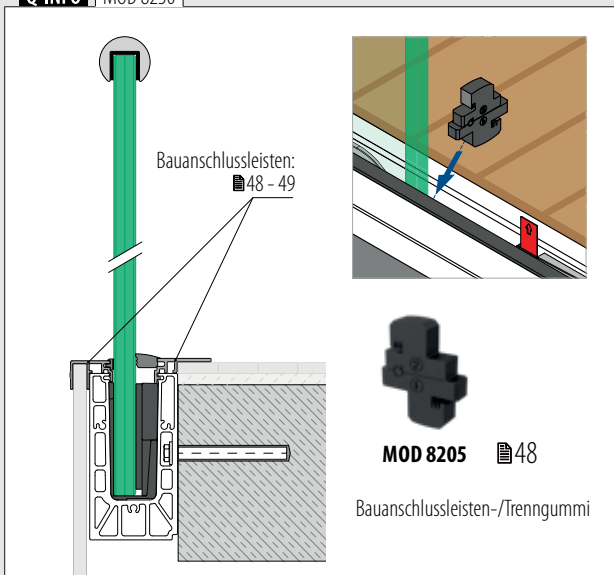

Q-INFO MOD 8230

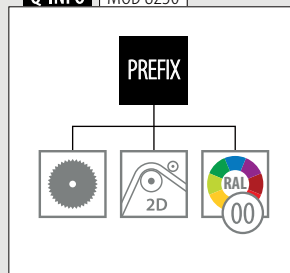

Q-INFO Aluminium



Q-INFO

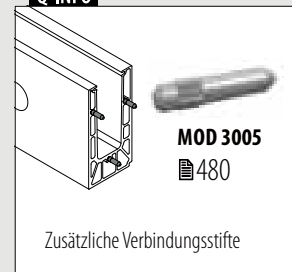

Endkappen zur Seitenmontage

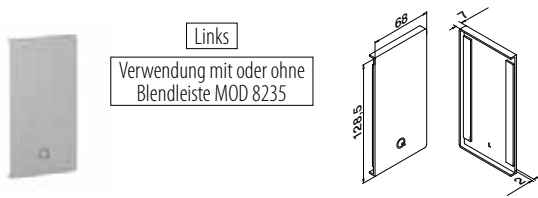

**MOD 8232**

<b>Aluminium</b>	Roh		
	<b>Klebeband</b>		
168232-01-00	Beigelegt	1	
<b>Aluminium</b>	Gebürstet		
<b>OUTDOOR</b>			
168232-01-18	Angebracht	1	

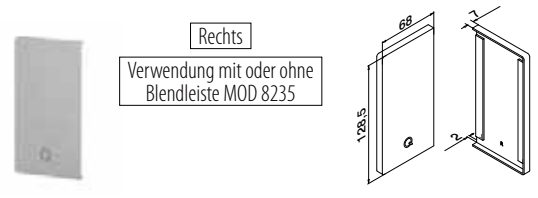

**MOD 8232**

<b>Aluminium</b>	Roh		
	<b>Klebeband</b>		
168232-02-00	Beigelegt	1	
<b>Aluminium</b>	Gebürstet		
<b>OUTDOOR</b>			
168232-02-18	Angebracht	1	

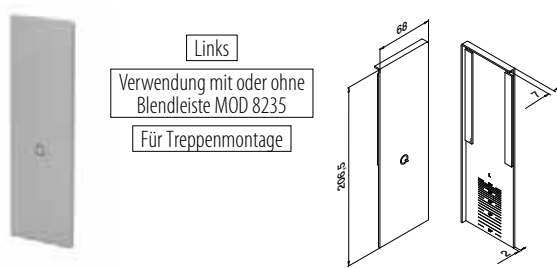

**MOD 8233**

<b>Aluminium</b>	Roh		
	<b>Klebeband</b>		
168233-01-00	Beigelegt	1	
<b>Aluminium</b>	Gebürstet		
<b>OUTDOOR</b>			
168233-01-18	Angebracht	1	

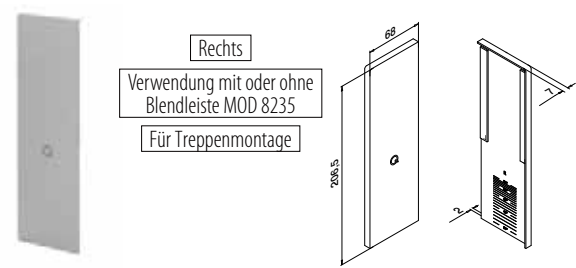

**MOD 8233**

<b>Aluminium</b>	Roh		
	<b>Klebeband</b>		
168233-02-00	Beigelegt	1	
<b>Aluminium</b>	Gebürstet		
<b>OUTDOOR</b>			
168233-02-18	Angebracht	1	



**Q-INFO Aluminium**



**Q-INFO MOD 8232 / 8233**

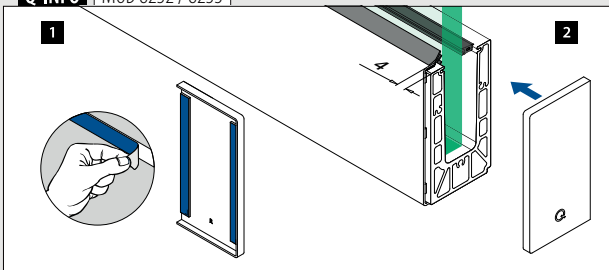

**Q-INFO MOD 8233**

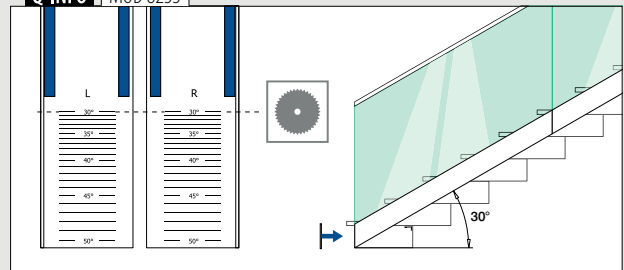



Geländerbasis

Endkappen zur Seitenmontage

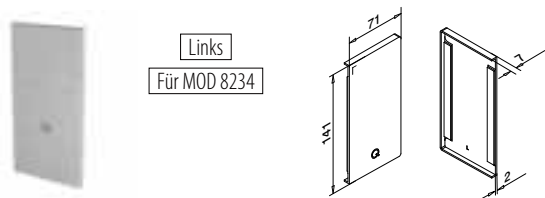

**MOD 8232**

<b>Aluminium</b>	Roh	<b>Klebeband</b>	
168232-41-00	Beigelegt		1
<b>Aluminium</b>	Gebürstet	<b>OUTDOOR</b>	
168232-41-18	Angebracht		1

NEW

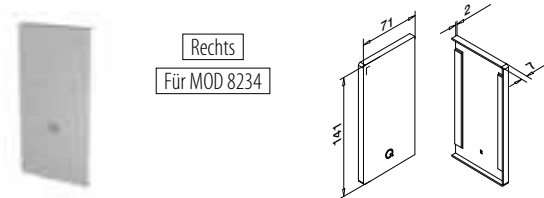

**MOD 8232**

<b>Aluminium</b>	Roh	<b>Klebeband</b>	
168232-42-00	Beigelegt		1
<b>Aluminium</b>	Gebürstet	<b>OUTDOOR</b>	
168232-42-18	Angebracht		1

NEW

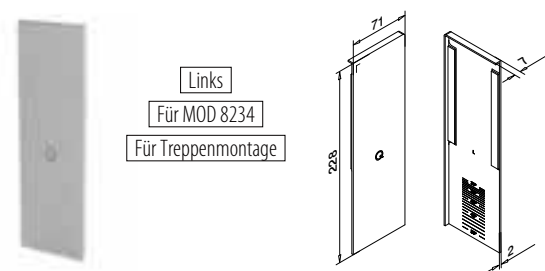

**MOD 8233**

<b>Aluminium</b>	Gebürstet	<b>OUTDOOR</b>	<b>Klebeband</b>	
168233-41-18	Angebracht			1

NEW

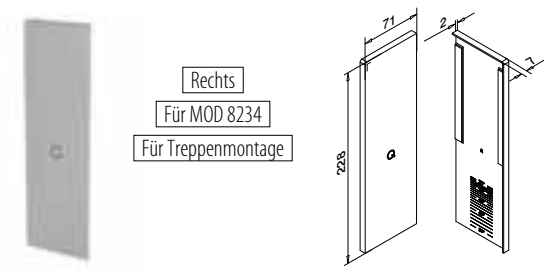

**MOD 8233**

<b>Aluminium</b>	Gebürstet	<b>OUTDOOR</b>	<b>Klebeband</b>	
168233-42-18	Angebracht			1

NEW



**Q-INFO** Aluminium

00

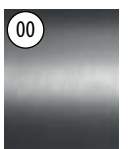

Roh

18

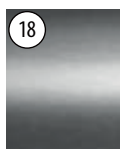

Gebürstet,  
anodisiert

## Drainageleisten zur Seitenmontage

4 Stück für 2,5-Meter-Bodenprofil  
8 Stück für 5-Meter-Bodenprofil

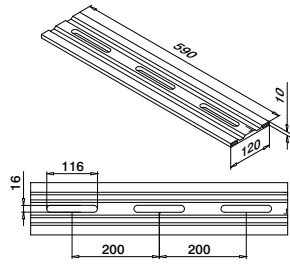

## MOD 8237

**Aluminium** Gebürstet  
**OUTDOOR**

168237-18



4

## Blendstopfen zur Seitenmontage



Verwendung  
ohne Blendeiste

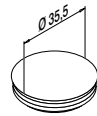

## MOD 8238

**Kunststoff** Aluminium RAL 9006  
**INDOOR**

158238-36



10

## Unterlegscheiben zur Seitenmontage

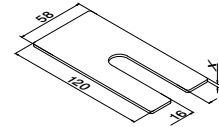

## MOD 8236

**Aluminium** Roh

	X	
168236-001	1	100
168236-002	2	100
168236-003	3	100

## Glas-Stopp



Für Treppmontage

## MOD 8204

**Zubehör**

208204



1

NEW

## Q-INFO MOD 8237

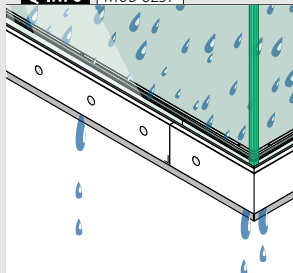

Montage-  
informationen:



[https://q-ne.ws/  
Smart23](https://q-ne.ws/Smart23)



## Q-INFO MOD 8236

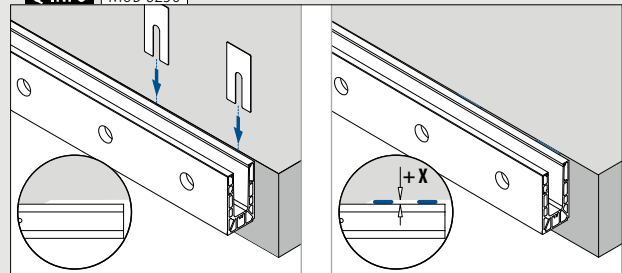

## Q-INFO MOD 8238

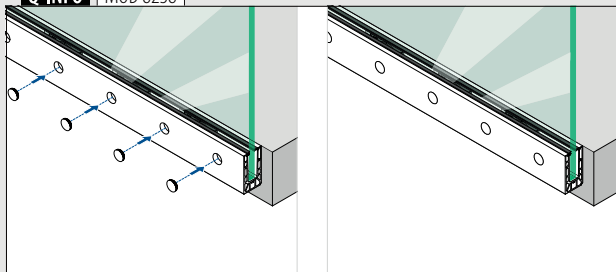

## Q-INFO MOD 8204

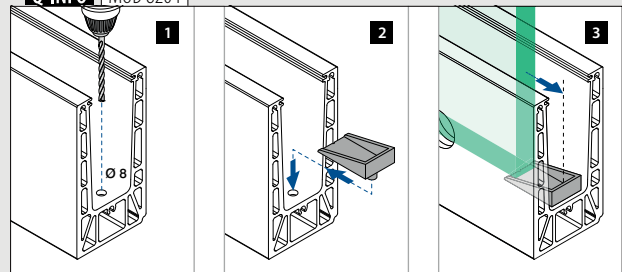

Geländerbasis

Blendleisten zur Seitenmontage

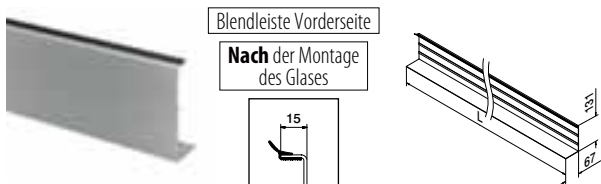

**MOD 8235**

<b>Aluminium</b> Roh		<b>Klebeband</b>	
SELL OUT	168235-050-00	Nicht inkl.*	L = 5 m
<b>Aluminium</b> Gebürstet			
<b>OUTDOOR</b>			
SELL OUT	168235-050-18	Angebracht	L = 5 m

\*Bestellen Sie MOD 1360 (Klebeband)



**MOD 8234**

<b>Aluminium</b> Roh		
	168234-050-00	L = 5 m
<b>Aluminium</b> Gebürstet		
<b>OUTDOOR</b>		
	168234-050-18	L = 5 m
<b>NEW</b>		

Zubehör

Acrylat-Klebeband



**MOD 1360**

<b>Zubehör</b>				
	<b>Q</b>	<b>W</b>	<b>L</b>	
201360	Q-53	9	33 m (für 11 m Blendleiste)	1

**SELL OUT** Nur solange der Vorrat reicht.

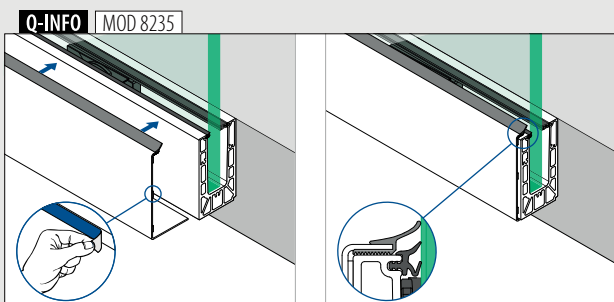

**Q-INFO** MOD 8235-050-00 / 1360

Montage-Informationen:

<https://q-ne.ws/Smart23>

**Q-INFO** **Aluminium**

<b>00</b>	<b>18</b>
Roh	Gebürstet, anodisiert

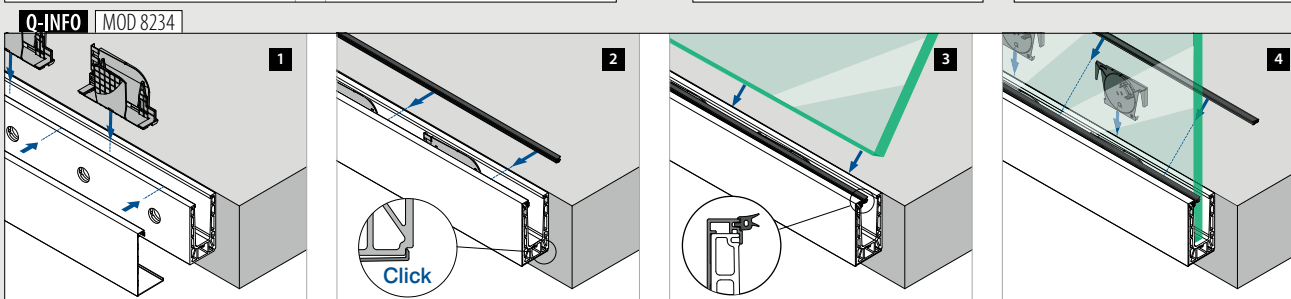





Bodenprofile zur Seitenmontage

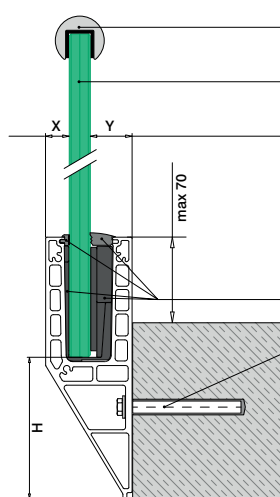

Glasleistenrohre: ■ 169 - 185  
Kantenschutz: ■ 166 - 168

VSG aus ESG: ■ 160 - 161

Glaskehlung und -justierung  
X = variabel X = 18,5  
Y = 28,5 Y = variabel  
H = 140 H = 138

Zur nicht justierbaren Glaskehlung

Q-disc® System: ■ 31, 32

Anker: ■ 459 - 465

Bitte beachten Sie die Spezifikationen wie Befestigungs- und Glasmaße sowie Glastypeen der jeweiligen Zertifikate und statischen Berechnungen.

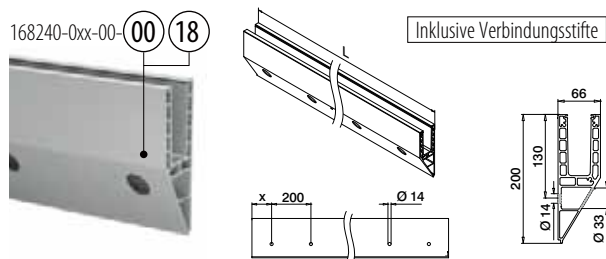

**MOD 8240**

<b>Aluminium</b>	Roh		
	<b>X</b>		
168240-050-00-00	100	■ 459 - 465	L = 5 m
<b>Aluminium</b>	Gebürstet		
<b>OUTDOOR</b>			
168240-025-00-18	50	■ 459 - 465	L = 2,5 m
168240-050-00-18	100	■ 459 - 465	L = 5 m



Internationaler Geschmacksmusterschutz

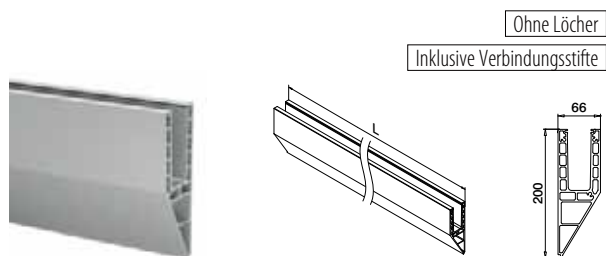

**MOD 8240**

<b>Aluminium</b>	Gebürstet		
168240-050-99-18		■ 459 - 465	L = 5 m



Internationaler Geschmacksmusterschutz

**Q-INFO**

Bauanschlussleisten: ■ 48 - 49

**MOD 8205** ■ 48

Bauanschlussleisten-/Trenngummi

**Q-INFO**

**Q-INFO Aluminium**

<b>00</b>	<b>18</b>
Roh	Gebürstet, anodisiert

**Q-INFO**

**MOD 3005** ■ 480

Zusätzliche Verbindungsstifte



Ecken zur Seitenmontage

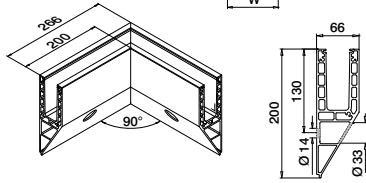
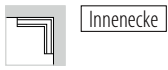

**MOD 8241**

<b>Aluminium</b>	Gebürstet		
<b>OUTDOOR</b>	<b>W</b>		
168241-01-18	100*	459 - 465	1



Internationaler Geschmacksmusterschutz

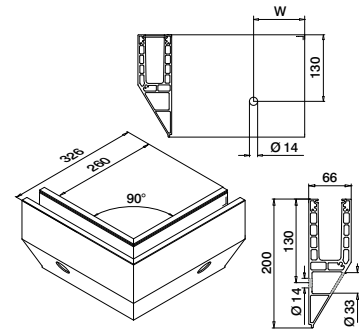

**MOD 8241**

<b>Aluminium</b>	Gebürstet		
<b>OUTDOOR</b>	<b>W</b>		
168241-02-18	100*	459 - 465	1



Internationaler Geschmacksmusterschutz

\*Die Lochposition kann produktionsbedingt abweichen.

Endkappen zur Seitenmontage



Links  
Verwendung  
ohne Blendleiste

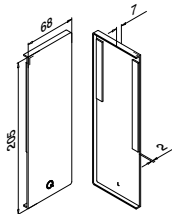

**MOD 8242**

<b>Aluminium</b>	Roh		
	<b>Kleband</b>		
168242-01-00	Beigelegt		1
<b>Aluminium</b>	Gebürstet		
<b>OUTDOOR</b>			
168242-01-18	Angebracht		1



Rechts  
Verwendung  
ohne Blendleiste

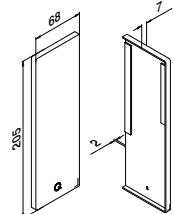

**MOD 8242**

<b>Aluminium</b>	Roh		
	<b>Kleband</b>		
168242-02-00	Beigelegt		1
<b>Aluminium</b>	Gebürstet		
<b>OUTDOOR</b>			
168242-02-18	Angebracht		1



Links  
Verwendung mit oder ohne  
Blendleiste MOD 8245  
Für Treppmontage

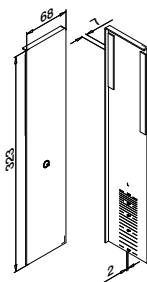

**MOD 8243**

<b>Aluminium</b>	Gebürstet		
<b>OUTDOOR</b>	<b>Kleband</b>		
168243-01-18	Angebracht		1



Rechts  
Verwendung mit oder ohne  
Blendleiste MOD 8245  
Für Treppmontage

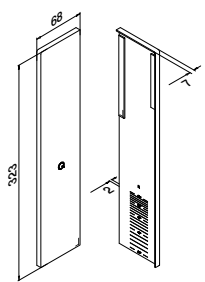

**MOD 8243**

<b>Aluminium</b>	Gebürstet		
<b>OUTDOOR</b>	<b>Kleband</b>		
168243-02-18	Angebracht		1



**Q-INFO** MOD 8242 / 8243

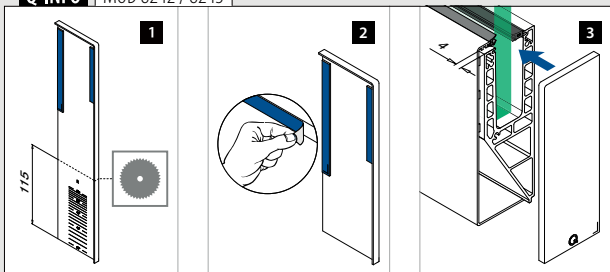

**Q-INFO** MOD 8243

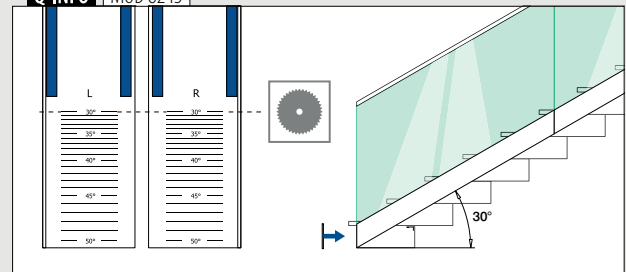



Geländerbasis

Endkappen zur Seitenmontage

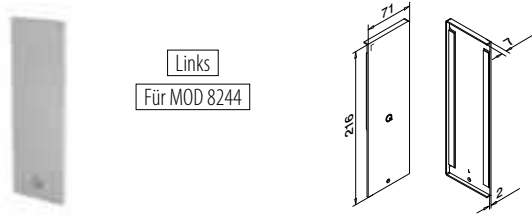

Links  
Für MOD 8244

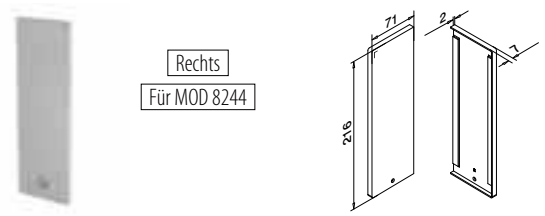

Rechts  
Für MOD 8244

MOD 8242

<b>Aluminium</b> Roh	<b>Klebeband</b>	
168242-41-00	Beigelegt	1
<b>Aluminium</b> Gebürstet		
<b>OUTDOOR</b>		
168242-41-18	Angebracht	1

NEW

MOD 8242

<b>Aluminium</b> Roh	<b>Klebeband</b>	
168242-42-00	Beigelegt	1
<b>Aluminium</b> Gebürstet		
<b>OUTDOOR</b>		
168242-42-18	Angebracht	1

NEW

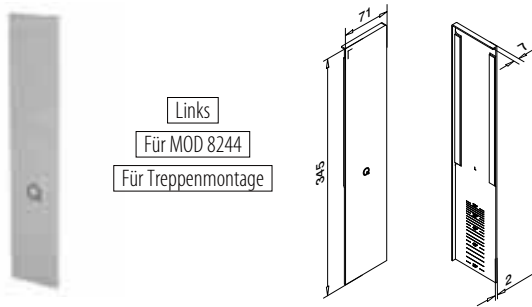

Links  
Für MOD 8244  
Für Treppenmontage

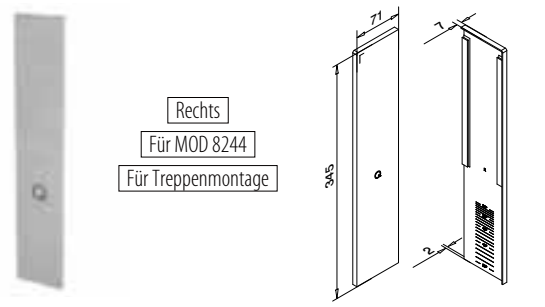

Rechts  
Für MOD 8244  
Für Treppenmontage

MOD 8243

<b>Aluminium</b> Gebürstet	<b>Klebeband</b>	
168243-41-18	Angebracht	1

NEW



MOD 8243

<b>Aluminium</b> Gebürstet	<b>Klebeband</b>	
168243-42-18	Angebracht	1

NEW



Geländerbasis

Glas-Stopp



MOD 8204

<b>Zubehör</b>		
208204		1

NEW

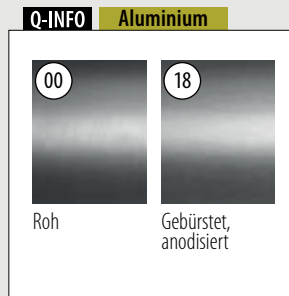
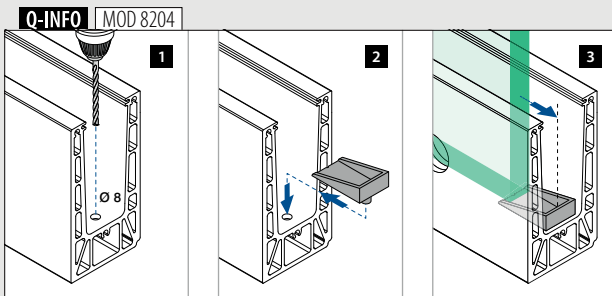

Blendleisten zur Seitenmontage

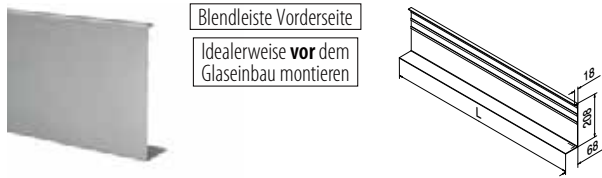

**MOD 8245**

<b>Aluminium</b>	Roh		
		<b>Klebeband</b>	
<b>SELL OUT</b>	168245-050-00	Nicht inkl.*	L = 5 m
<b>Aluminium</b>	Gebürstet		
		<b>OUTDOOR</b>	
<b>SELL OUT</b>	168245-050-18	Angebracht	L = 5 m



\*Bestellen Sie MOD 1360 (Klebeband)

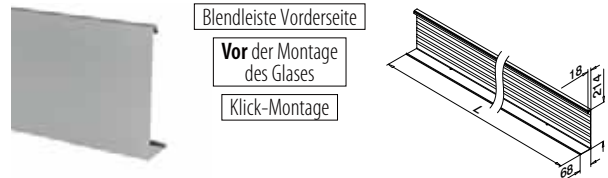

**MOD 8244**

<b>Aluminium</b>	Roh		
		<b>Klebeband</b>	
	168244-050-00		L = 5 m
<b>Aluminium</b>	Gebürstet		
		<b>OUTDOOR</b>	
	168244-050-18		L = 5 m



Zubehör

Acrylat-Klebeband



**MOD 1360**

<b>Zubehör</b>					
	<b>Q</b>	<b>W</b>	<b>L</b>		
201360	Q-53	9	33 m (für 11 m Blendleiste)	1	

**Q-INFO** MOD 8245-050-00 / 1360

Montage-Informationen:



**SELL OUT** Nur solange der Vorrat reicht.

**Q-INFO** MOD 8245

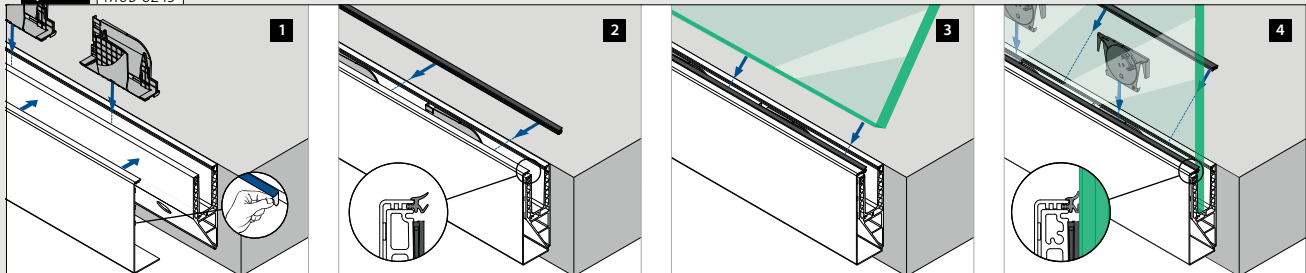

**Q-INFO** MOD 8244

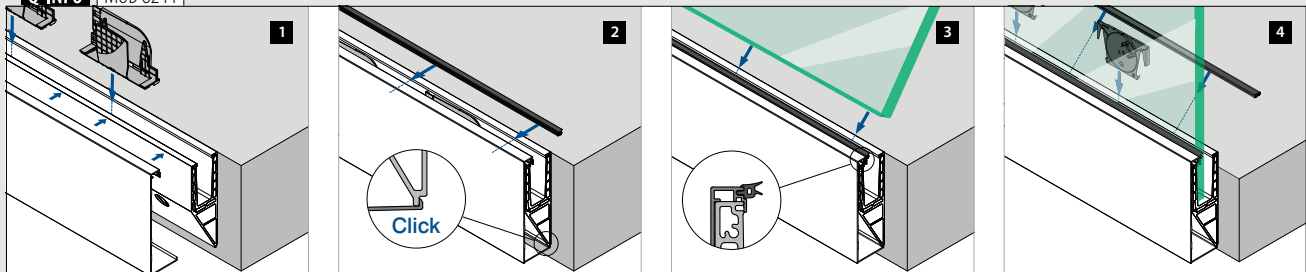

Geländerbasis

Bauanschlussleisten zur Bodenmontage

Für alle Smart-Profile

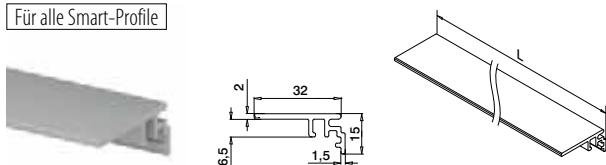

**MOD 6973**

<b>Aluminium</b>	Roh	
166973-50-00		L = 5 m
<b>Aluminium</b>	Gebürstet	
<b>OUTDOOR</b>		
166973-50-18		L = 5 m

**PREFIX**

Für Smart **Boden-**  
montage- und **F**-Profile

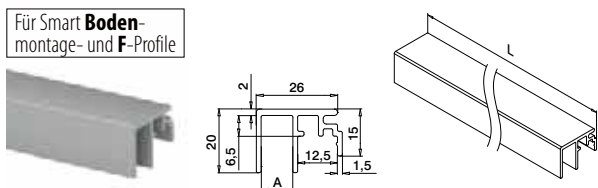

**MOD 6972**

<b>Aluminium</b>	Roh	
	<b>A</b>	
166972-010-50-00	10	L = 5 m
<b>Aluminium</b>	Gebürstet	
<b>OUTDOOR</b>		
166972-010-50-18	10	L = 5 m

**PREFIX**

Für alle Smart-Profile

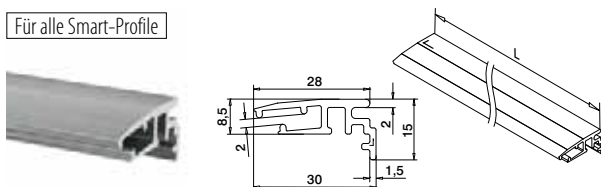

**MOD 6979**

<b>Aluminium</b>	Roh	
166979-002-50-00		L = 5 m
<b>Aluminium</b>	Gebürstet	
<b>OUTDOOR</b>		
166979-002-50-18		L = 5 m

**NEW**

**PREFIX**

Für Smart **Boden-**  
montage- und **F**-Profile

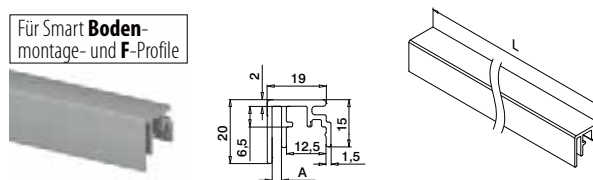

**MOD 6972**

<b>Aluminium</b>	Roh	
	<b>A</b>	
166972-003-50-00	3	L = 5 m
<b>Aluminium</b>	Gebürstet	
<b>OUTDOOR</b>		
166972-003-50-18	3	L = 5 m

**PREFIX**

Für Smart **Boden-**  
montage- und **F**-Profile

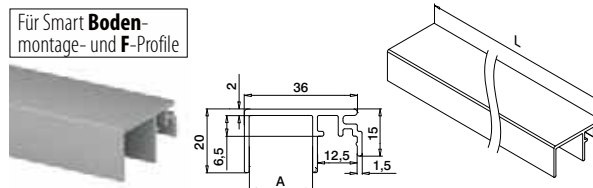

**MOD 6972**

<b>Aluminium</b>	Roh	
	<b>A</b>	
166972-020-50-00	20	L = 5 m
<b>Aluminium</b>	Gebürstet	
<b>OUTDOOR</b>		
166972-020-50-18	20	L = 5 m

**PREFIX**

Geländerbasis

Bauanschlussleisten-/Trenngummi



**MOD 8205**

<b>Zubehör</b>	
208205-010	5



**Q-INFO** Aluminium



**Q-INFO**

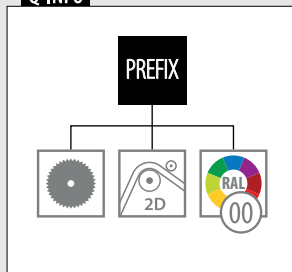

**Q-INFO** MOD 8205

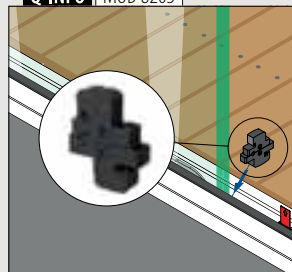

Bauanschlussleisten zur Seitenmontage

Für alle Smart-Profile

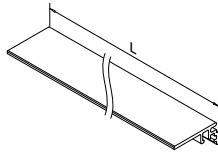
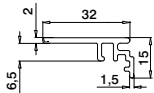

**MOD 6973**

<b>Aluminium</b>	Roh		
166973-50-00		L = 5 m	
<b>Aluminium</b>	Gebürstet		
<b>OUTDOOR</b>			
166973-50-18		L = 5 m	

PREFIX

Für Smart **Seiten-**  
montage- und **Y**-Profile

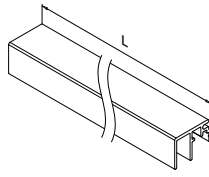
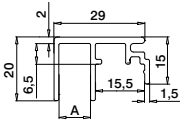

**MOD 6970**

<b>Aluminium</b>	Roh	<b>A</b>	
166970-010-50-00		10	L = 5 m
<b>Aluminium</b>	Gebürstet		
<b>OUTDOOR</b>			
166970-010-50-18		10	L = 5 m

PREFIX

Für Smart **Seiten-**  
montage- und **Y**-Profile

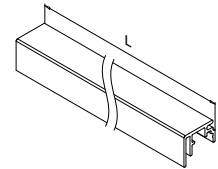
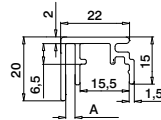

**MOD 6970**

<b>Aluminium</b>	Roh	<b>A</b>	
166970-003-50-00		3	L = 5 m
<b>Aluminium</b>	Gebürstet		
<b>OUTDOOR</b>			
166970-003-50-18		3	L = 5 m

PREFIX

Für Smart **Seiten-**  
montage- und **Y**-Profile

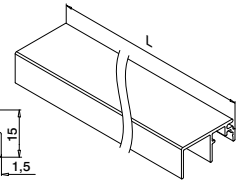
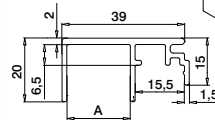

**MOD 6970**

<b>Aluminium</b>	Roh	<b>A</b>	
166970-020-50-00		20	L = 5 m
<b>Aluminium</b>	Gebürstet		
<b>OUTDOOR</b>			
166970-020-50-18		20	L = 5 m

PREFIX

**Q-INFO** MOD 6979

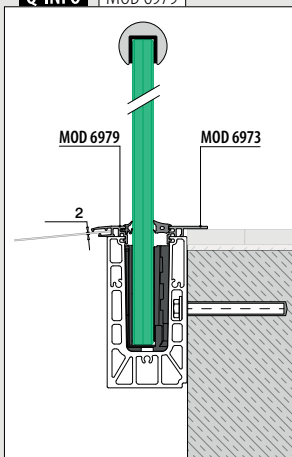

**Q-INFO** MOD 6972-010 / 6973

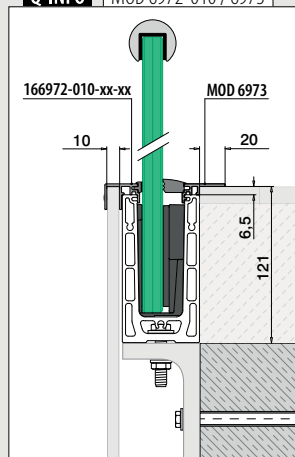

**Q-INFO** MOD 6972-020 / 6973

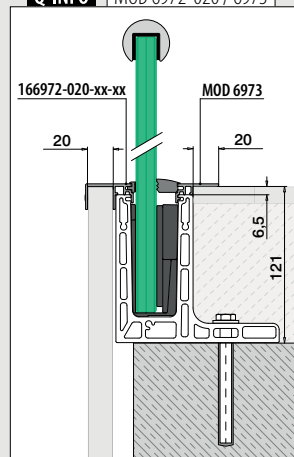

**Q-INFO** MOD 6970-010 / 6973

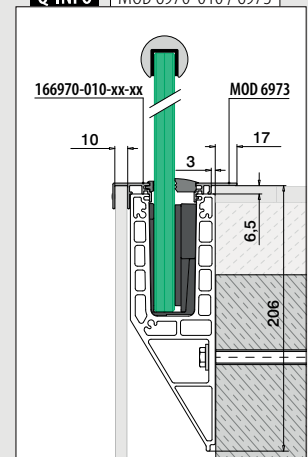





**Beanspruchung:** Leicht und mittel  
**Verwendung:** Innen- und Außenbereich  
**Montage:** Boden-, In-Boden- und Seitenmontage  
**Anwendung:** Balkone, Galerien, Wege, Abtrennungen, Treppen und französische Balkone  
**Material:** Aluminium (gebürstet anodisiert und roh)  
**Glasstärke:** 16,76 bis 21,52 mm

Finden Sie alle Informationen zu Easy Glass Smart+ online:



<https://q-ne.ws/SmartPlus23>

# EASY GLASS<sup>®</sup> SMART+



red dot winner 2020  
innovative product



# Installieren und justieren Sie auch 16,76 - 21,52 mm starkes Glas schnell und einfach

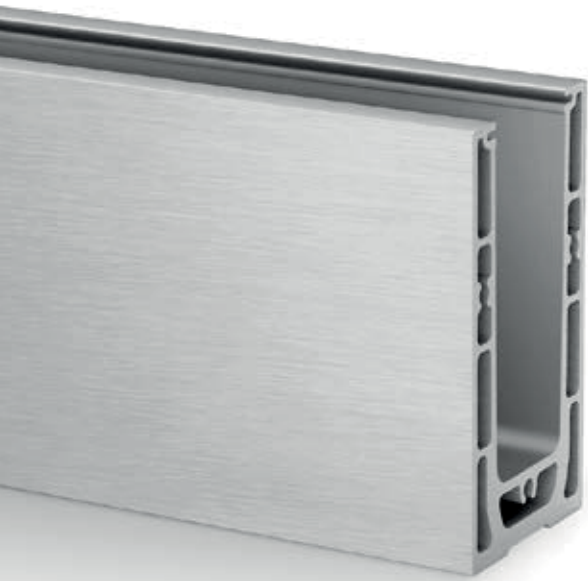

Suchen Sie nach einer Lösung, um Glas bis zu 21,52 mm einfach zu montieren – und darüber hinaus die einzelnen Glasscheiben präzise auszurichten? Dann kommt mit Easy Glass® Smart+ nun die Antwort. Ähnlich wie beim Schwestersystem Easy Glass® Smart müssen Sie bei Smart+ nur die Bodenprofile montieren, das Glas einsetzen und fixieren. Mithilfe des justierbaren Q-disc® Systems können Sie die Glasfüllung zudem auch in der Vertikalen ausrichten.

## Easy Glass® Smart+

Max. Holmlast (kN/m)

DE

1,0

STATISCHE  
BERECHNUNG  
DIN18008

AbP  
BALAST  
GEPRÜFT

Bitte beachten Sie die Spezifikationen wie Befestigungs- und Glasmaße sowie Glastypeen der jeweiligen Zertifikate.

## International getestet/berechnet/zertifiziert:



- 1 Mit dem justierbaren Q-disc System können Sie die Glasfüllung nicht nur fixieren, sondern auch um 0,6° in der Vertikalen ausrichten.
- 2 Die Q-disc gibt Ihnen direktes Feedback dank des Klickgeräusches während der Montage.
- 3 Speziell entwickelt für laminiertes Glas mit einer Stärke von 16,76 oder 21,52 mm.

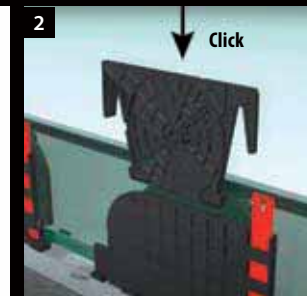
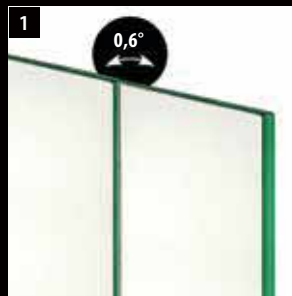

## EASY GLASS® SMART+ MONTAGEOPTIONEN

### Smart+

#### Bodenmontage

- Auch für die In-Bodenmontage

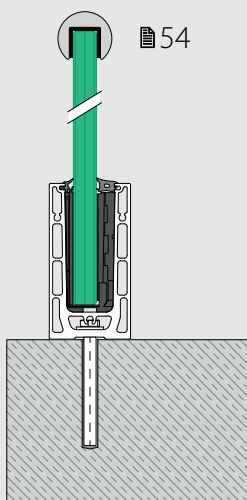

### Smart+

#### Seitenmontage

- Auch zur Montage an der Innenseite von Aufmauerungen
- Bodenprofil-Blendleiste erhältlich

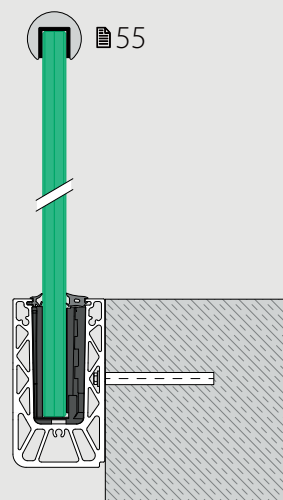

**COMING SOON**

### F und Y Bodenprofile

#### Smart+ F

#### Bodenmontage

- Für Rohfußböden
- Kann direkt an oder über der Bodenkante angebracht werden

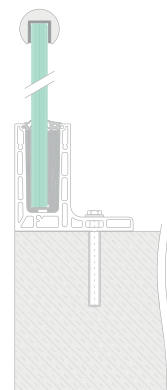

#### Smart+ Y

#### Seitenmontage

- Für Rohfußböden
- Kann direkt an oder über der Bodenkante angebracht werden

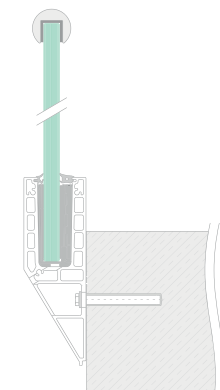



# JUSTIERBARES Q-DISC® SYSTEM SCHIEBEN UND AUSRICHTEN!



## SO FUNKTIONIERT'S

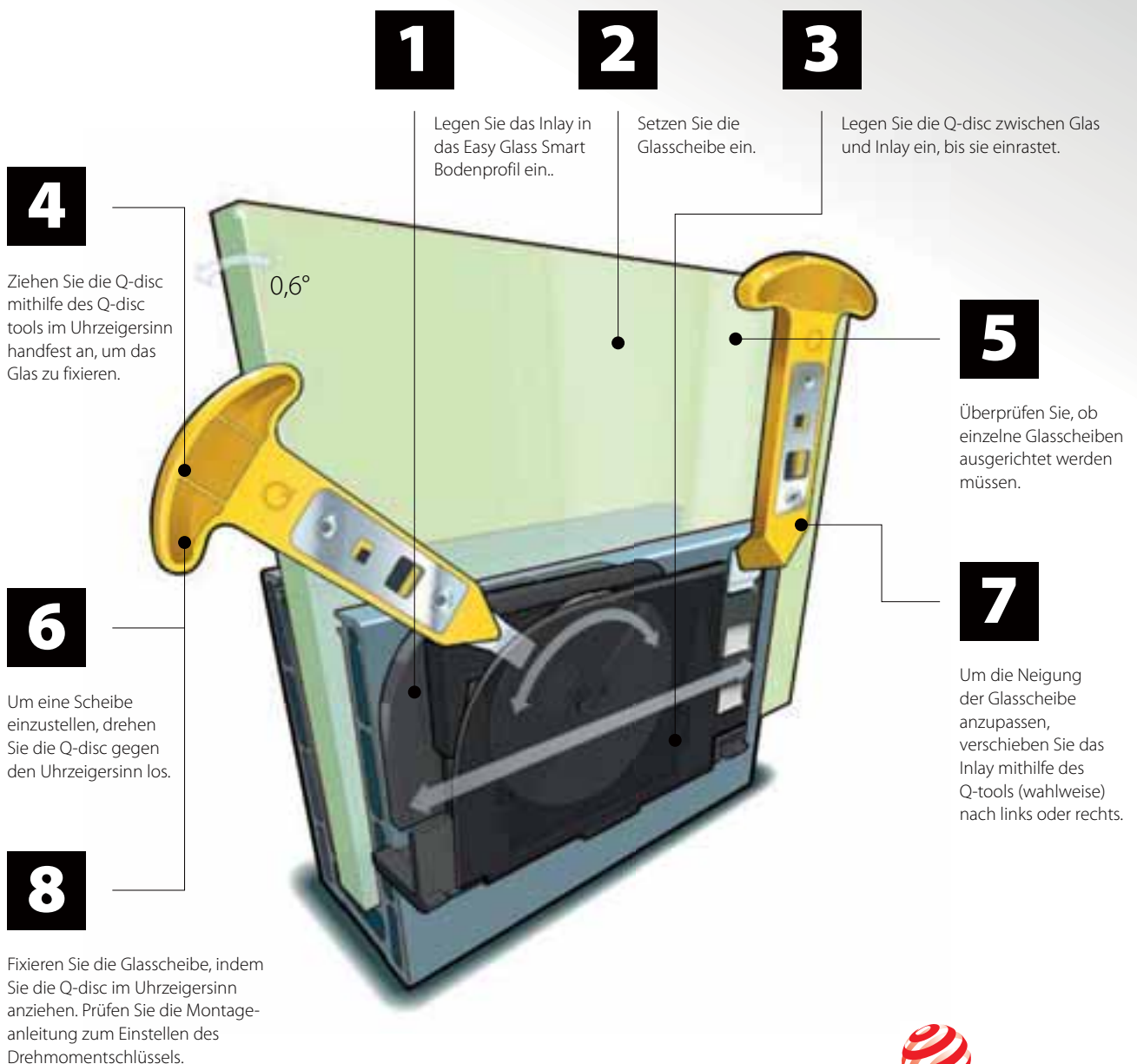

reddot winner 2020  
innovative product

Q-disc® System (Gummi, Inlay und Q-disc®)

Glasklemmung und -justierung

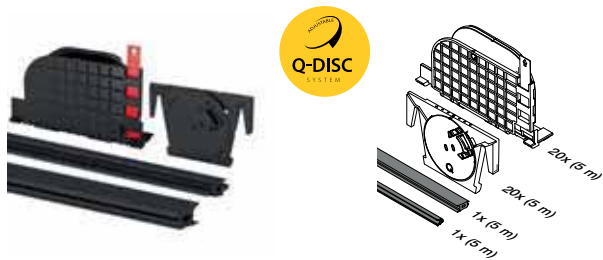

MOD 8301

Zubehör		
Für laminiertes Glas	T	
208301-050-17	16,76	L = 5 m
208301-050-18	17,52	L = 5 m
208301-050-22	21,52	L = 5 m
208301-250-17	16,76	L = 25 m
208301-250-18	17,52	L = 25 m
208301-250-22	21,52	L = 25 m



Internationaler Geschmacksmusterschutz

Q-disc®- und Inlay-Werkzeug



MOD 1000

Zubehör		
	Q	
201000	Q-84	1

Einzelne Gummis



MOD 8207

Zubehör		
208207-250-00		L = 25 m



MOD 8207

Zubehör		
Für laminiertes Glas	T	
208207-250-14	16,76 - 17,52	L = 25 m
208207-250-18	21,52	L = 25 m



Q-disc®-Sets

Glasklemmung und -justierung



MOD 8309

Zubehör		
Für laminiertes Glas	T	
208309-17	16,76	5
208309-18	17,52	5
208309-22	21,52	5



Q-INFO MOD 1000

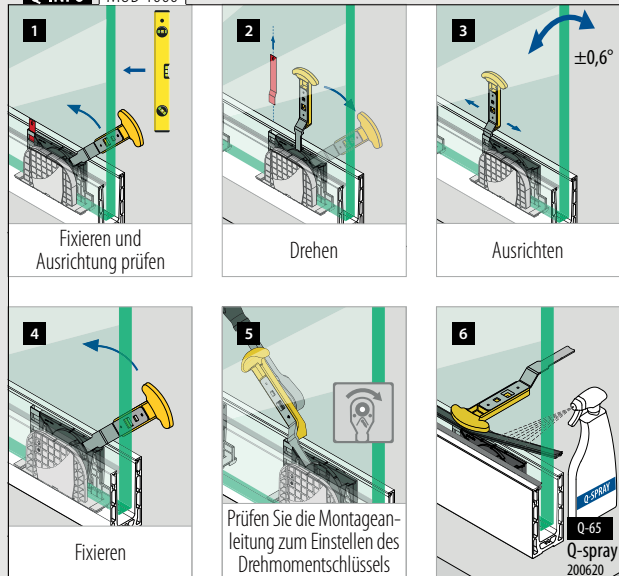

Q-INFO

Installationsblech

MOD 1002

482





Geländerbasis

**Bodenprofile zur Bodenmontage**

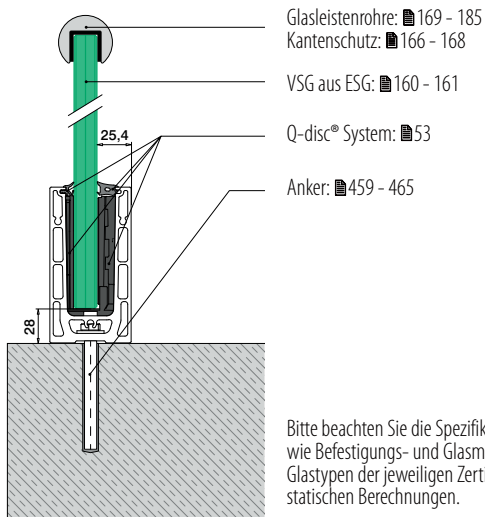

Bitte beachten Sie die Spezifikationen wie Befestigungs- und Glasmaße sowie Glastypen der jeweiligen Zertifikate und statischen Berechnungen.

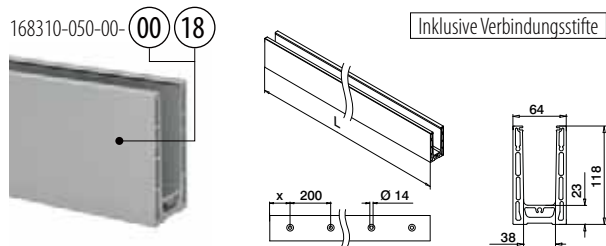

**MOD 8310**

<b>Aluminium</b> Roh	X		
168310-050-00	100	459 - 465	L = 5 m
<b>Aluminium</b> Gebürstet			
<b>OUTDOOR</b>			
168310-025-00-18	50	459 - 465	L = 2,5 m
168310-050-00-18	100	459 - 465	L = 5 m



Internationaler Geschmacksmusterschutz

Geländerbasis

**Ecken zur Bodenmontage**

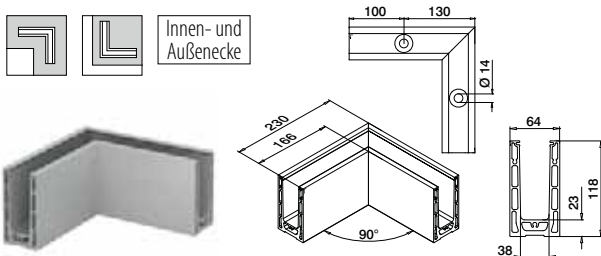

**MOD 8311**

<b>Aluminium</b> Roh		
168311-00-00	459 - 465	1
<b>Aluminium</b> Gebürstet		
<b>OUTDOOR</b>		
168311-00-18	459 - 465	1



Internationaler Geschmacksmusterschutz

Geländerbasis

**Endkappen zur Bodenmontage**



**MOD 8312**

<b>Aluminium</b> Roh	<b>Klebeband</b>	
168312-00-00	Beigelegt	1
<b>Aluminium</b> Gebürstet		
<b>OUTDOOR</b>		
168312-00-18	Angebracht	1



Q-INFO MOD 8310

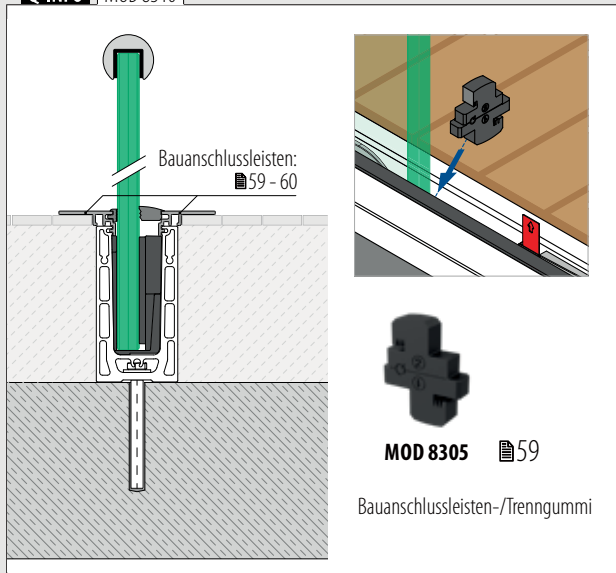

Q-INFO MOD 8310

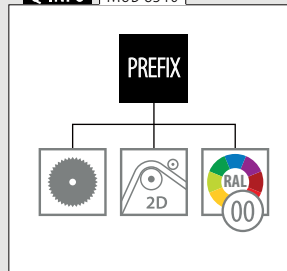

Q-INFO MOD 8310 / 8311



Q-INFO MOD 8312

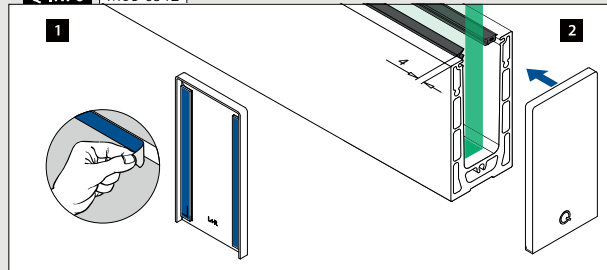

Bodenprofile zur Seitenmontage

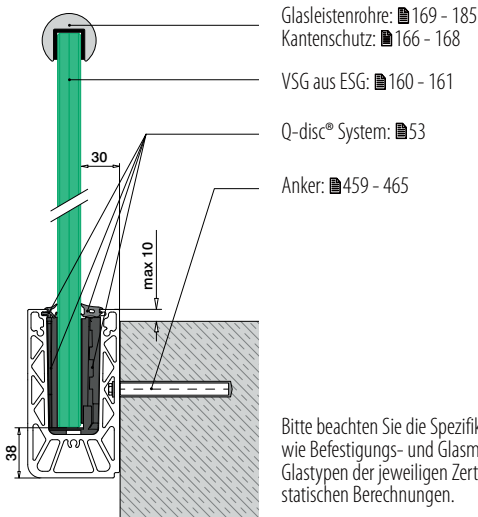

Glasleistenrohre: ■ 169 - 185  
Kantenschutz: ■ 166 - 168  
VSG aus ESG: ■ 160 - 161  
Q-disc® System: ■ 53  
Anker: ■ 459 - 465

Bitte beachten Sie die Spezifikationen wie Befestigungs- und Glasmaße sowie Glastypen der jeweiligen Zertifikate und statischen Berechnungen.

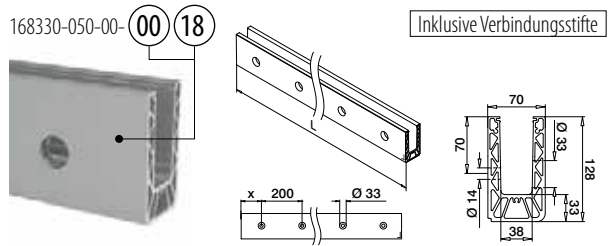

MOD 8330

Aluminium	Roh	X	■ 459 - 465	L = 5 m
168330-050-00	00	18		
Aluminium	Gebürstet	OUTDOOR		
168330-025-00-18	50		■ 459 - 465	L = 2,5 m
168330-050-00-18	100		■ 459 - 465	L = 5 m



Internationaler Geschmacksmusterschutz

Ecken zur Seitenmontage

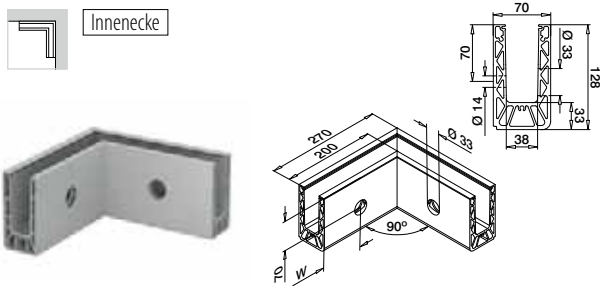

MOD 8331

Aluminium	Roh	W	■ 459 - 465	1
168331-01-00	00*			
Aluminium	Gebürstet	OUTDOOR		
168331-01-18	100*		■ 459 - 465	1

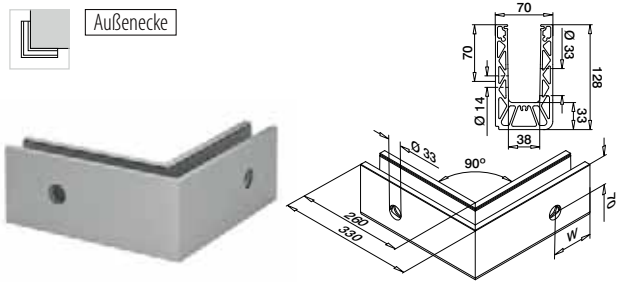

MOD 8331

Aluminium	Roh	W	■ 459 - 465	1
168331-02-00	00*			
Aluminium	Gebürstet	OUTDOOR		
168331-02-18	100*		■ 459 - 465	1



\*Die Lochposition kann produktionsbedingt abweichen.

Q-INFO MOD 8330

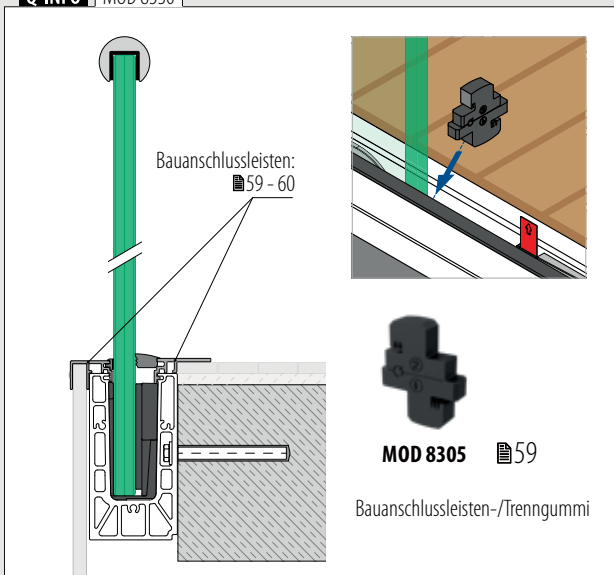

Bauanschlussleisten: ■ 59 - 60

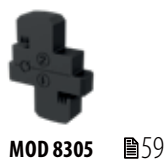

MOD 8305 ■ 59  
Bauanschlussleisten-/Trenngummi

Q-INFO MOD 8330

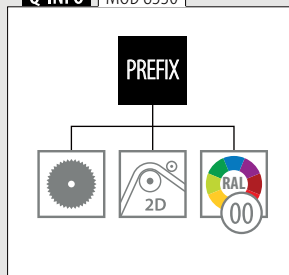

Q-INFO Aluminium



Q-INFO

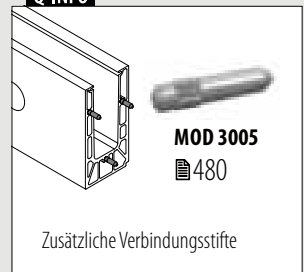

MOD 3005  
■ 480

Zusätzliche Verbindungsstifte

Geländerbasis

Endkappen zur Seitenmontage

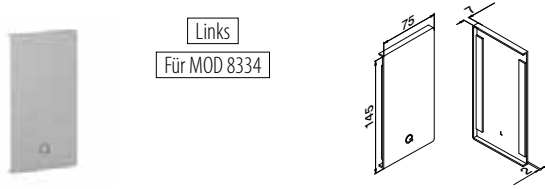

Links  
Für MOD 8334

MOD 8332

<b>Aluminium</b>	Roh		
	<b>Klebeband</b>		
168332-41-00	Beigelegt	1	
<b>Aluminium</b>	Gebürstet		
<b>OUTDOOR</b>			
168332-41-18	Angebracht	1	

NEW

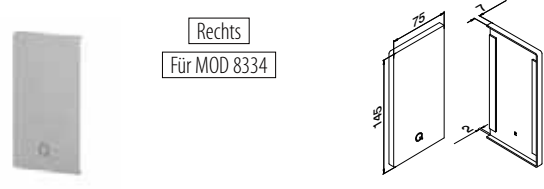

Rechts  
Für MOD 8334

MOD 8332

<b>Aluminium</b>	Roh		
	<b>Klebeband</b>		
168332-42-00	Beigelegt	1	
<b>Aluminium</b>	Gebürstet		
<b>OUTDOOR</b>			
168332-42-18	Angebracht	1	

NEW

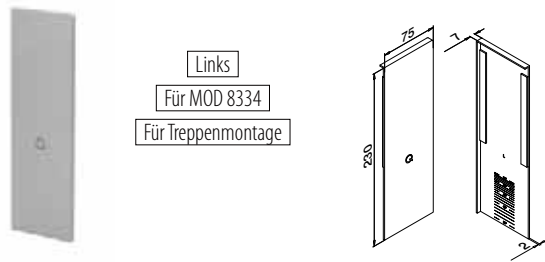

Links  
Für MOD 8334  
Für Treppenmontage

MOD 8333

<b>Aluminium</b>	Gebürstet		
<b>OUTDOOR</b>	<b>Klebeband</b>		
168333-41-18	Angebracht	1	

NEW

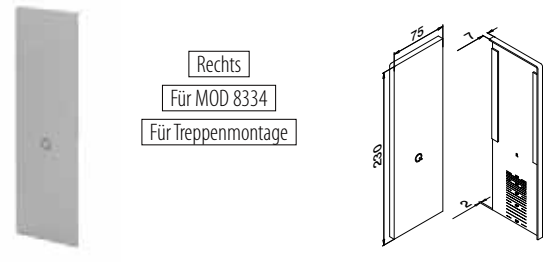

Rechts  
Für MOD 8334  
Für Treppenmontage

MOD 8333

<b>Aluminium</b>	Gebürstet		
<b>OUTDOOR</b>	<b>Klebeband</b>		
168333-42-18	Angebracht	1	

NEW



Geländerbasis

Drainageleisten zur Seitenmontage

4 Stück für 2,5-Meter-Bodenprofil  
8 Stück für 5-Meter-Bodenprofil

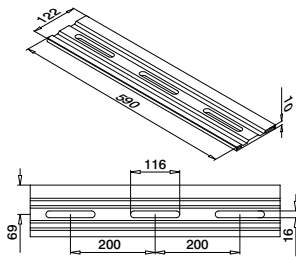

MOD 8337

<b>Aluminium</b>	Gebürstet		
<b>OUTDOOR</b>			
168337-18		4	

NEW

Geländerbasis

Unterlegscheiben zur Seitenmontage

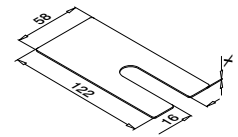

MOD 8336

<b>Aluminium</b>	Roh		
	<b>X</b>		
168336-001	1	100	
168336-002	2	100	
168336-003	3	100	

NEW

Q-INFO MOD 8337

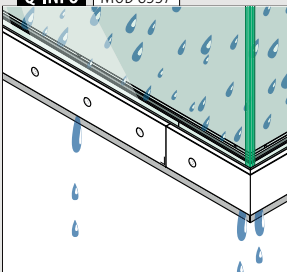

Montage-  
informationen:



<https://q-ne.ws/SmartPlus23>

Q-INFO MOD 8336

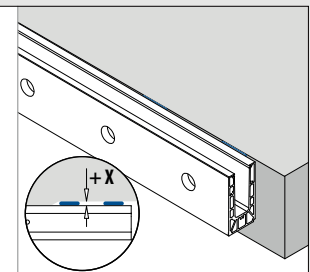
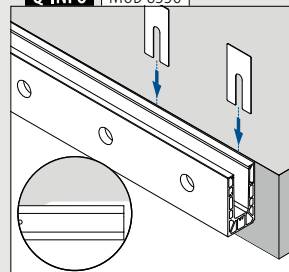

## Blendleisten zur Seitenmontage

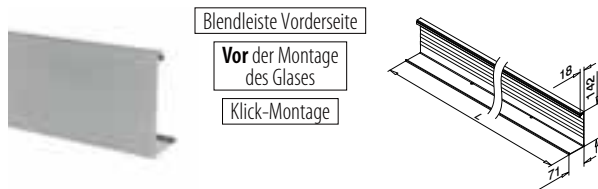

Blendleiste Vorderseite

Vor der Montage  
des Glases

Klick-Montage

### MOD 8334

<b>Aluminium</b>	Roh	
168334-050-00	L = 5 m	
<b>Aluminium</b>	Gebürstet	
<b>OUTDOOR</b>		
168334-050-18	L = 5 m	

NEW

## Blendstopfen zur Seitenmontage

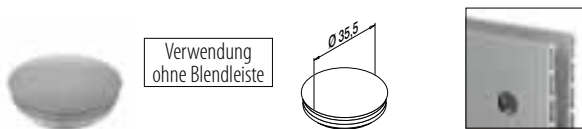

Verwendung  
ohne Blendleiste

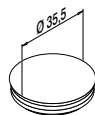

### MOD 8238

<b>Kunststoff</b>	Aluminium RAL 9006	
<b>INDOOR</b>		
158238-36	10	

## Glas-Stopp



Für Treppenmontage

### MOD 8304

<b>Zubehör</b>	
208304	1

NEW

### Q-INFO Aluminium

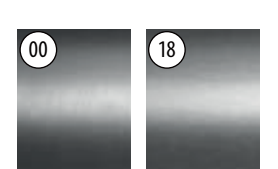

Roh Gebürstet,  
anodisiert

### Q-INFO MOD 8334

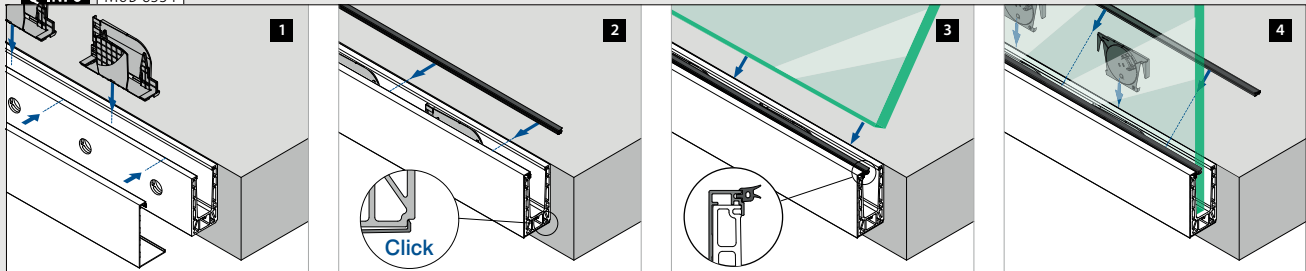

### Q-INFO MOD 8238

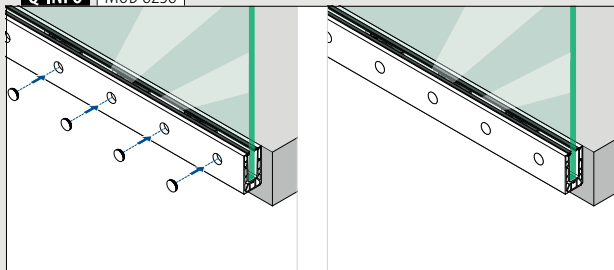

### Q-INFO MOD 8304

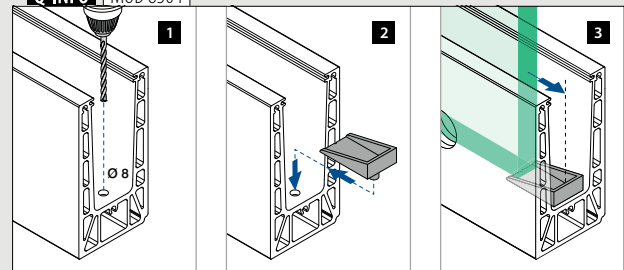



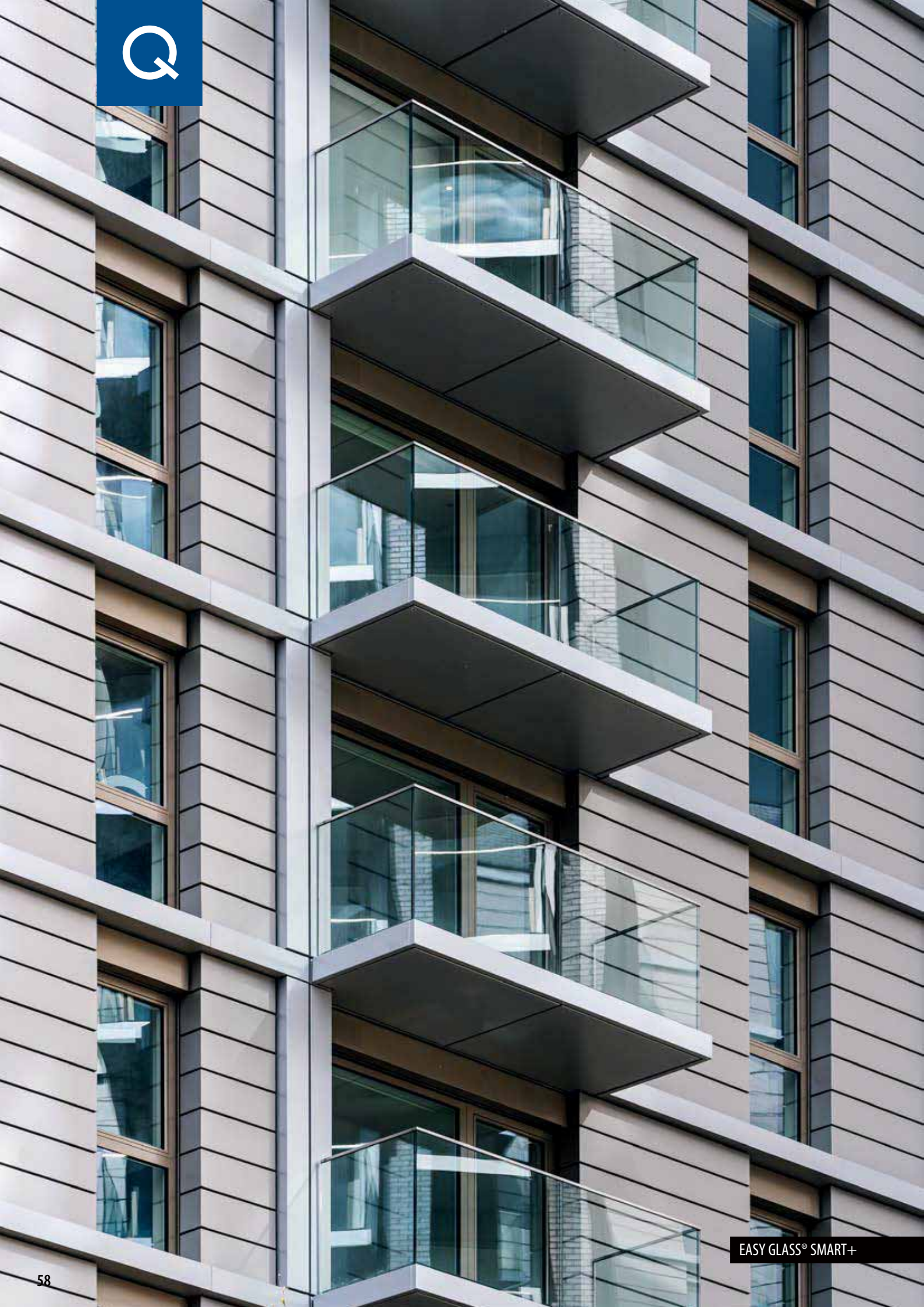

## Bauanschlussleisten

Für alle Smart+-Profile

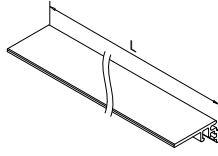
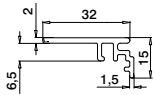

## MOD 6973

<b>Aluminium</b>	Roh	
166973-50-00	L = 5 m	
<b>Aluminium</b>	Gebürstet	
<b>OUTDOOR</b>		
166973-50-18	L = 5 m	

PREFIX

Für Smart+ Bodenmontage

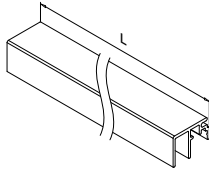
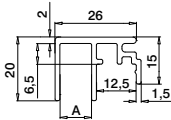

## MOD 6972

<b>Aluminium</b>	Roh	
	<b>A</b>	
166972-010-50-00	10	L = 5 m
<b>Aluminium</b>	Gebürstet	
<b>OUTDOOR</b>		
166972-010-50-18	10	L = 5 m

PREFIX

Für alle Smart+-Profile

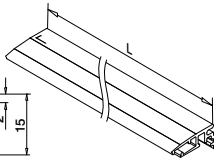
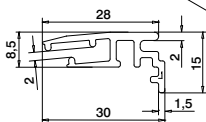

## MOD 6979

<b>Aluminium</b>	Roh	
166979-002-50-00	L = 5 m	
<b>Aluminium</b>	Gebürstet	
<b>OUTDOOR</b>		
166979-002-50-18	L = 5 m	

NEW

PREFIX

Für Smart+ Bodenmontage

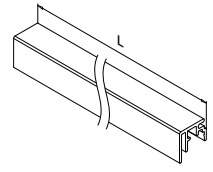
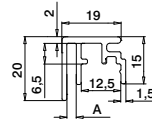

## MOD 6972

<b>Aluminium</b>	Roh	
	<b>A</b>	
166972-003-50-00	3	L = 5 m
<b>Aluminium</b>	Gebürstet	
<b>OUTDOOR</b>		
166972-003-50-18	3	L = 5 m

PREFIX

Für Smart+ Bodenmontage

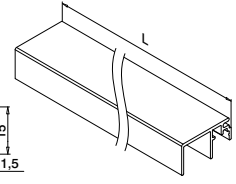
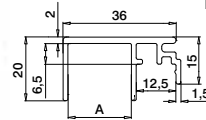

## MOD 6972

<b>Aluminium</b>	Roh	
	<b>A</b>	
166972-020-50-00	20	L = 5 m
<b>Aluminium</b>	Gebürstet	
<b>OUTDOOR</b>		
166972-020-50-18	20	L = 5 m

PREFIX

Geländerbasis

## Bauanschlussleisten-/Trenngummi

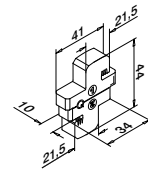

## MOD 8305

<b>Zubehör</b>	
208305-010	5

NEW

PREFIX

Q-INFO MOD 6979

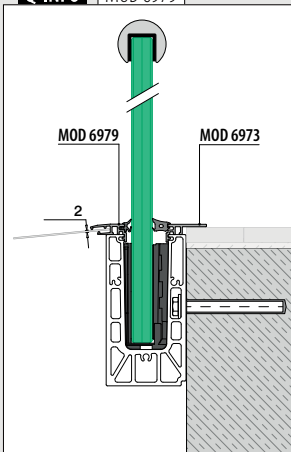

Q-INFO MOD 6972-010 / 6973

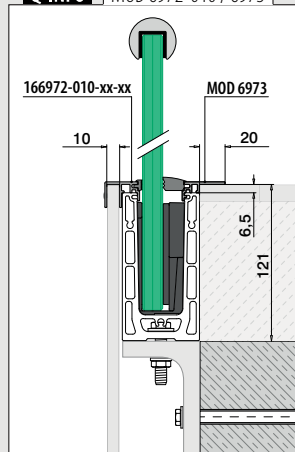

Q-INFO MOD 8305

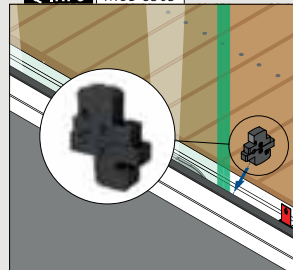

Bauanschlussleisten

Für alle Smart+-Profile

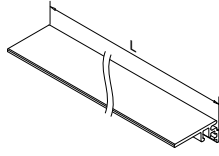
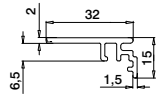

**MOD 6973**

<b>Aluminium</b>	Roh		
166973-50-00		L = 5 m	
<b>Aluminium</b>	Gebürstet		
<b>OUTDOOR</b>			
166973-50-18		L = 5 m	

PREFIX

Für Smart+ Seitenmontage

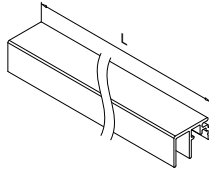
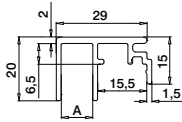

**MOD 6970**

<b>Aluminium</b>	Roh	<b>A</b>	
166970-010-50-00		10	L = 5 m
<b>Aluminium</b>	Gebürstet		
<b>OUTDOOR</b>			
166970-010-50-18		10	L = 5 m

PREFIX

Für Smart+ Seitenmontage

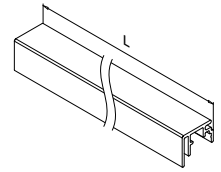
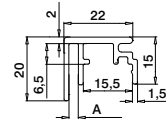

**MOD 6970**

<b>Aluminium</b>	Roh	<b>A</b>	
166970-003-50-00		3	L = 5 m
<b>Aluminium</b>	Gebürstet		
<b>OUTDOOR</b>			
166970-003-50-18		3	L = 5 m

PREFIX

Für Smart+ Seitenmontage

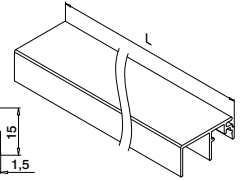
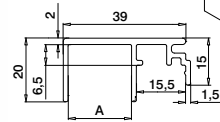

**MOD 6970**

<b>Aluminium</b>	Roh	<b>A</b>	
166970-020-50-00		20	L = 5 m
<b>Aluminium</b>	Gebürstet		
<b>OUTDOOR</b>			
166970-020-50-18		20	L = 5 m

PREFIX

Q-INFO

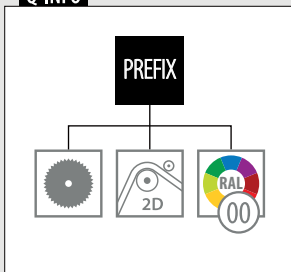

Q-INFO Aluminium





# EASY GLASS® SMART+ **HIGH F + Y** BODENPROFILE

**COMING SOON**

## EASY GLASS® SMART+ **HIGH Y**

### Seitenmontage

- Für hohe Bodenaufbauten bis zu 180 mm, Gesamthöhe des Profils: 305 mm
- Keine Konsole oder Unterkonstruktion notwendig
- Variable Höhe: Bodenaufbauten zwischen 160 und 180 mm möglich
- Verkleidung für die gesamte Höhe des Profils, für ein einheitliches Aussehen
- Kompatibel mit den Bauanschlussleisten und weiteren Zubehörartikeln der Easy Glass Smart+ Serie
- Speziell für die Treppenmontage entwickelt; keine Verlängerung mit Flachstahl oder ähnlichem notwendig

## EASY GLASS® SMART+ **HIGH F**

### Bodenmontage

- Für hohe Bodenaufbauten bis zu 180 mm
- Keine Konsole oder Unterkonstruktion notwendig
- Für innen und außen
- Perfekte Montagefläche, Verkleidungen können nachträglich angebracht werden
- Kompatibel mit den Bauanschlussleisten und weiteren Zubehörartikeln der Easy Glass Smart+ Serie





**Beanspruchung:** Leicht bis hoch  
**Verwendung:** Innen- und Außenbereich  
**Montage:** Boden- und Seitenmontage  
**Anwendung:** Balkone, Galerien, Wege, Abtrennungen, Treppen und französische Balkone  
**Material:** Aluminium (gebürstet anodisiert, roh und pulverbeschichtet in RAL 9005 schwarz)  
**Glasstärke:** 16,76 bis 25,52 mm

Finden Sie alle Informationen zu Easy Glass Prime online:

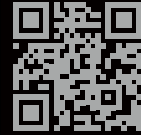

<https://q-ne.ws/Prime23>

# EASY GLASS® PRIME



red dot winner 2020  
innovative product

# Der Turbo für Ihre Projekte



Wenn Sie auf der Suche nach einem Glasgeländersystem für dickere Glasstärken sind und Sie die Glasscheiben zudem ausrichten möchten, ist Easy Glass® Prime genau das Richtige für Sie. Die Bodenprofile enthalten das verstellbare Q-disc® System, mit dem Sie das Glas durch einfaches Verschieben und Drehen ausrichten und sichern können. Dank der Größe der Bohrlöcher eignet sich das System auch für die Montage auf unebenen Oberflächen.

## Easy Glass® Prime

Max. Holmlast (kN/m)

DE

1,0

STATISCHE  
BERECHNUNG  
DIN18008

AbP  
BALAST  
GEPRÜFT

Bitte beachten Sie die Spezifikationen wie Befestigungs- und Glasmaße sowie Glastypeen der jeweiligen Zertifikate.

## International getestet/berechnet/zertifiziert:



- 1 Richten Sie die Glasscheiben um bis zu 1,2° in der Vertikalen aus.
- 2 Durch Markierungen und ein Klickgeräusch signalisiert die Q-disc die korrekte Installation.
- 3 Geeignet für Glasstärken zwischen 16,76 und 25,52 mm.

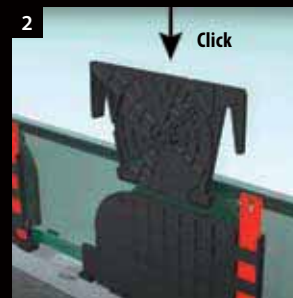
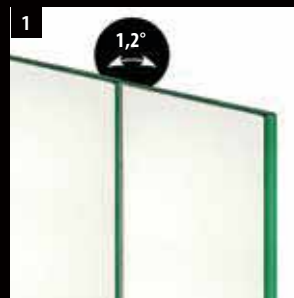

## EASY GLASS® PRIME MONTAGEOPTIONEN

### Prime

Bodenmontage

- Symmetrisches Bodenprofil

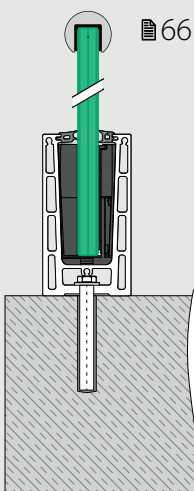

### Prime F

Bodenmontage

- Für Rohfußböden
- Kann direkt an oder über der Bodenkante angebracht werden

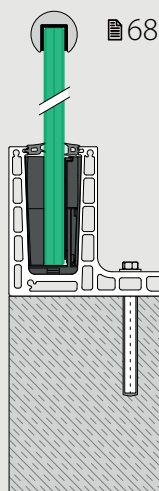

### Prime

Seitenmontage

- Auch zur Montage an der Innenseite von Aufmauerungen
- Bodenprofil-Blendeleiste erhältlich

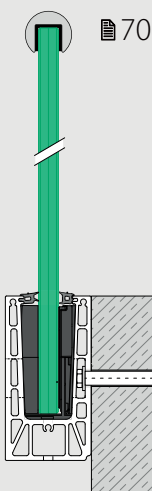

### Prime Y

Seitenmontage

- Für Rohfußböden
- Kann direkt an oder über der Bodenkante angebracht werden
- Bodenprofil-Blendeleiste erhältlich

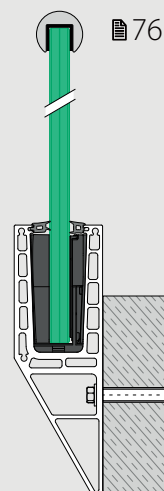



# JUSTIERBARES Q-DISC® SYSTEM SCHIEBEN UND AUSRICHTEN!



## SO FUNKTIONIERT'S

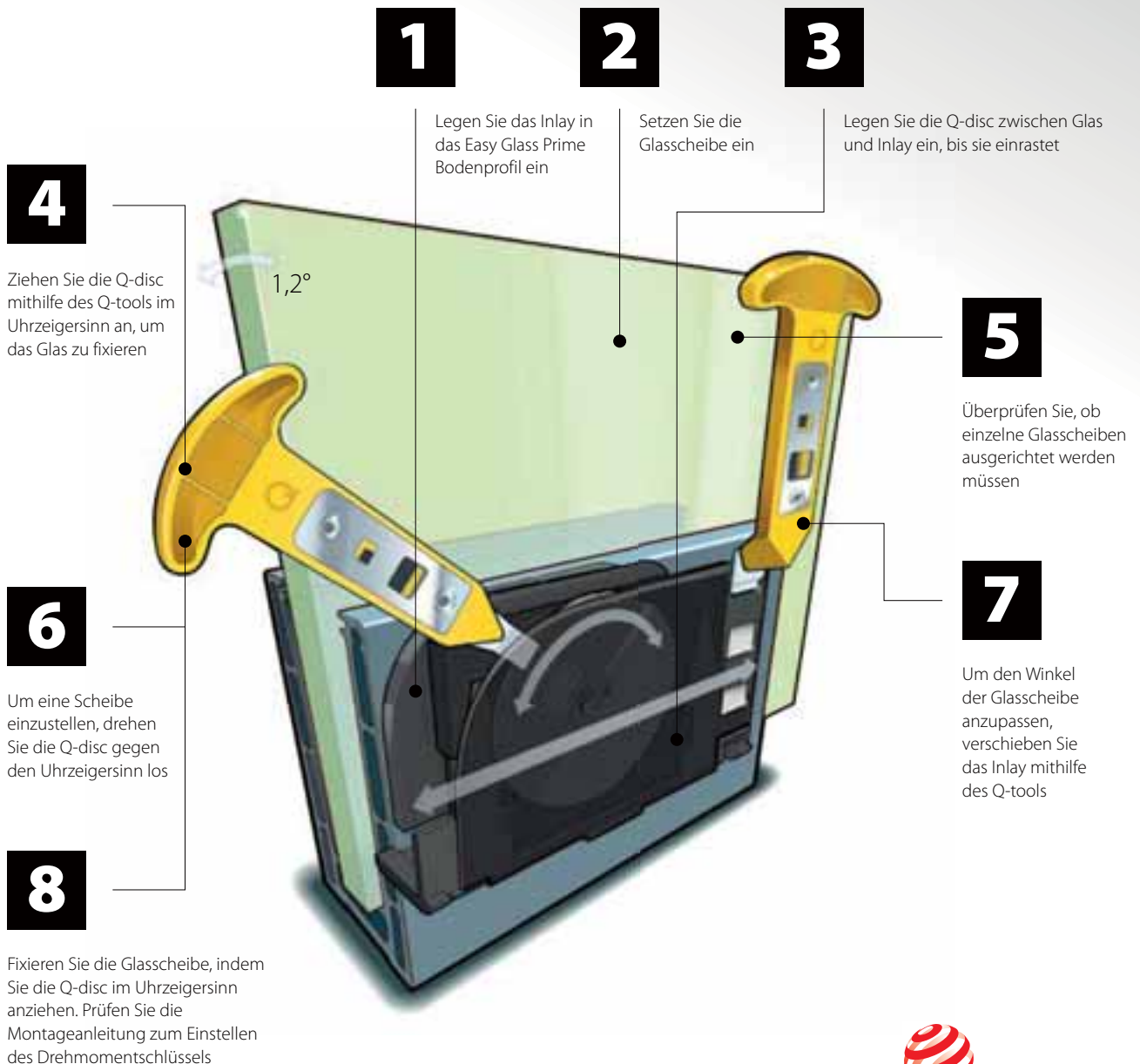

reddot winner 2020  
innovative product



## Q-disc® System (Gummi, Inlay und Q-disc®)

## Glasklemmung und -justierung



## MOD 8401

## Zubehör

Für monolithisches Glas	T	
208401-050-19	19	L = 5 m

## Für laminiertes Glas

208401-050-17	16,76	L = 5 m
208401-050-18	17,52	L = 5 m
208401-050-21	20,76	L = 5 m
208401-050-22	21,52	L = 5 m
208401-050-24	24,76	L = 5 m
208401-050-26	25,52	L = 5 m
208401-250-17	16,76	L = 25 m
208401-250-18	17,52	L = 25 m
208401-250-21	20,76	L = 25 m
208401-250-22	21,52	L = 25 m
208401-250-24	24,76	L = 25 m
208401-250-26	25,52	L = 25 m



Internationaler Geschmacksmusterschutz

## Zubehör

## Q-disc®- und Inlay-Werkzeug



## MOD 1000

## Zubehör

	Q	
201000	Q-84	1

## Q-INFO MOD 1000

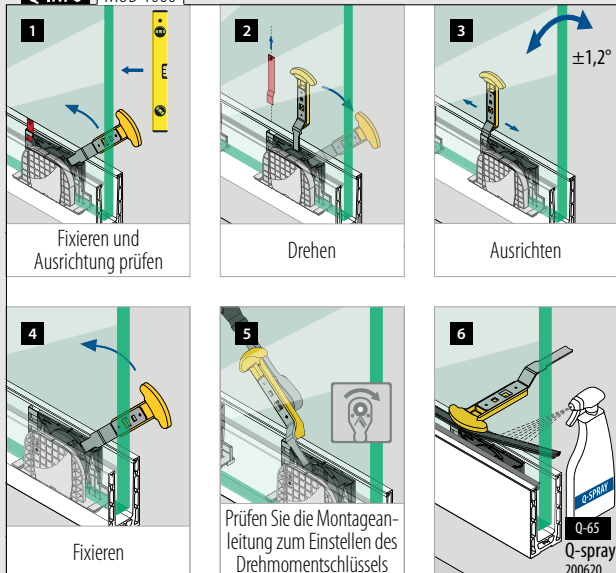

## Zubehör

## Einzelne Gummis



## MOD 8407

## Zubehör

208407-250-00	L = 25 m

NEW



## MOD 8407

## Zubehör

Für monolithisches Glas	T	
208407-250-19	19	L = 25 m

## Für laminiertes Glas

208407-250-17	16,76	L = 25 m
208407-250-18	17,52	L = 25 m
208407-250-21	20,76	L = 25 m
208407-250-22	21,52	L = 25 m
208407-250-24	24,76	L = 25 m
208407-250-26	25,52	L = 25 m

NEW

## Zubehör

## Q-disc®-Sets

## Glasklemmung und -justierung



## MOD 8409

## Zubehör

Für monolithisches Glas	T	
208409-19	19	5

## Für laminiertes Glas

208409-17	16,76	5
208409-18	17,52	5
208409-21	20,76	5
208409-22	21,52	5
208409-24	24,76	5
208409-26	25,52	5



## Q-INFO

Installationsblech

## MOD 1002

482





Geländerbasis

Bodenprofile zur Bodenmontage

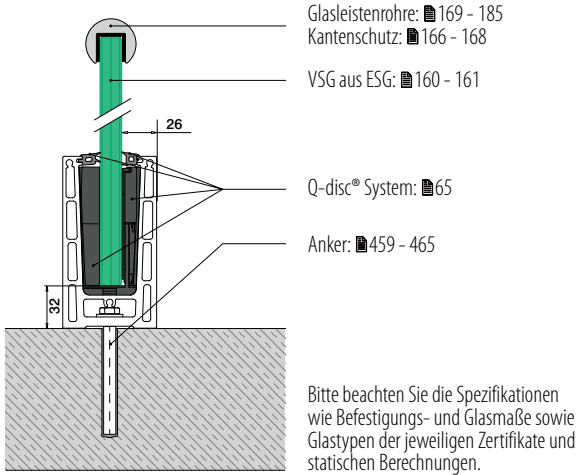

Geländerbasis

Ecken zur Bodenmontage

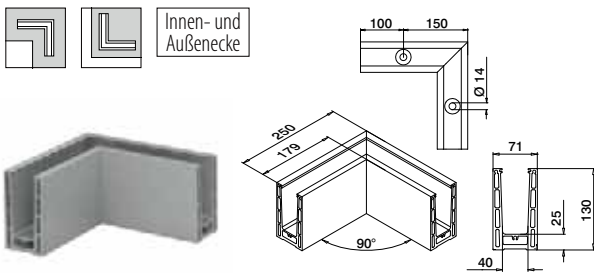

MOD 8411

Aluminium Roh		
168411-00-00	459 - 465	1
Aluminium Gebürstet		
<b>OUTDOOR</b>		
168411-00-18	459 - 465	1
Aluminium Black Line		
<b>OUTDOOR</b>		
<b>NEW</b> 168411-00-82	459 - 465	1

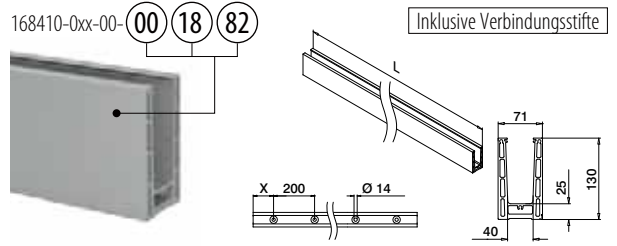

MOD 8410

Aluminium Roh	X		
168410-050-00-00	100	459 - 465	L = 5 m
Aluminium Gebürstet			
<b>OUTDOOR</b>			
168410-025-00-18	50	459 - 465	L = 2,5 m
168410-050-00-18	100	459 - 465	L = 5 m
Aluminium Black Line			
<b>OUTDOOR</b>			
<b>NEW</b> 168410-050-00-82	100	459 - 465	L = 5 m



Internationaler Geschmacksusterschutz

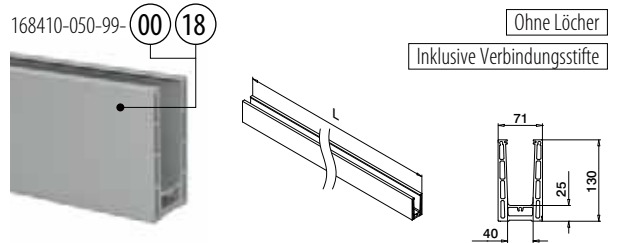

MOD 8410

Aluminium Roh		
168410-050-99-00		L = 5 m
Aluminium Gebürstet		
<b>OUTDOOR</b>		
168410-050-99-18		L = 5 m



Internationaler Geschmacksusterschutz

Q-INFO MOD 8410

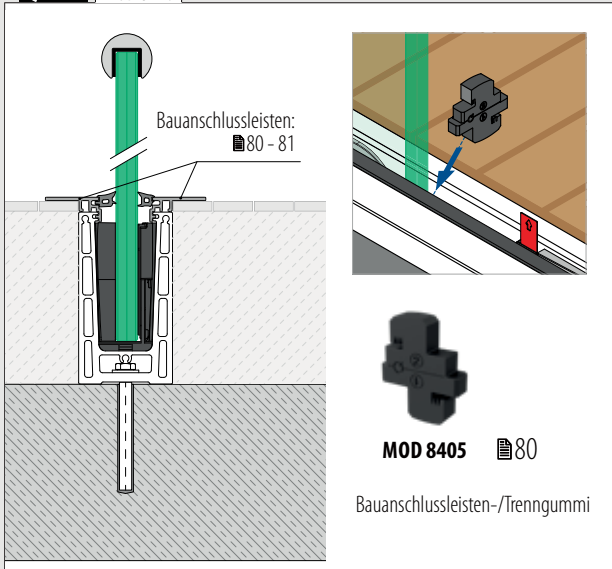

Q-INFO MOD 8410

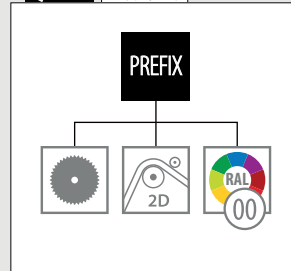

Q-INFO

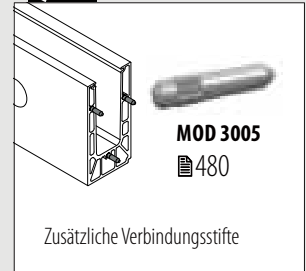

Q-INFO Aluminium



Endkappen zur Bodenmontage

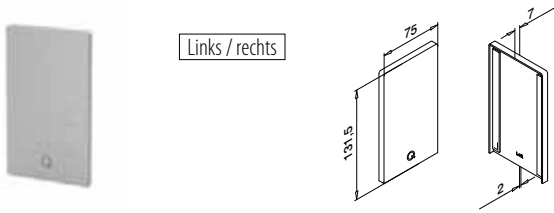

Links / rechts

MOD 8412

<b>Aluminium</b>	Roh		
		<b>Klebeband</b>	
168412-00-00	Beigelegt		1
<b>Aluminium</b>	Gebürstet		
		<b>OUTDOOR</b>	
168412-00-18	Angebracht		1
<b>Aluminium</b>	<b>Black Line</b>		
		<b>OUTDOOR</b>	
<b>NEW</b>	168412-00-82	Angebracht	1

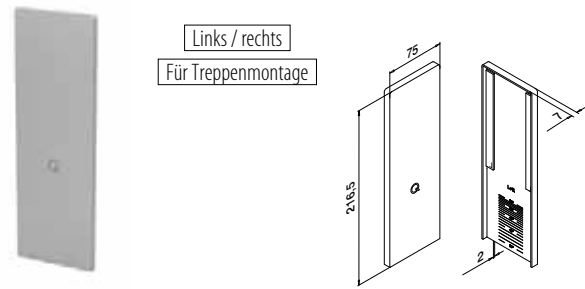

Links / rechts  
Für Treppmontage

MOD 8413

<b>Aluminium</b>	Roh		
		<b>Klebeband</b>	
168413-00-00	Beigelegt		1
<b>Aluminium</b>	Gebürstet		
		<b>OUTDOOR</b>	
168413-00-18	Angebracht		1



Unterlegscheiben zur Bodenmontage

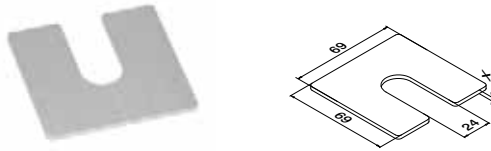

MOD 8416

<b>Aluminium</b>	Roh		
		<b>X</b>	
168416-001	1		100
168416-002	2		100
168416-003	3		100

Drainageleisten zur Bodenmontage

4 Stück für 2,5-Meter-Bodenprofil  
8 Stück für 5-Meter-Bodenprofil

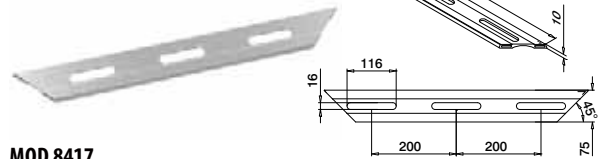

MOD 8417

<b>Aluminium</b>	Gebürstet		
		<b>OUTDOOR</b>	
168417-18			4

Q-INFO MOD 8412

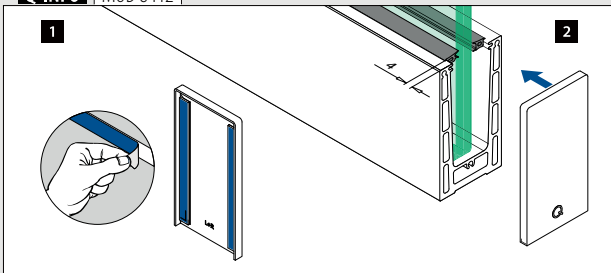

Q-INFO MOD 8416

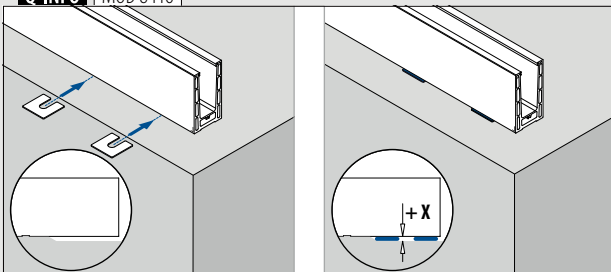

Q-INFO MOD 8413

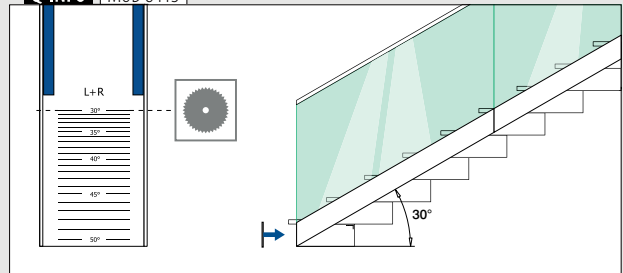

Q-INFO MOD 8417

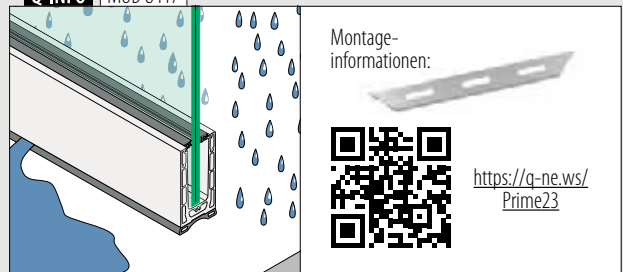

Bodenprofile zur Bodenmontage

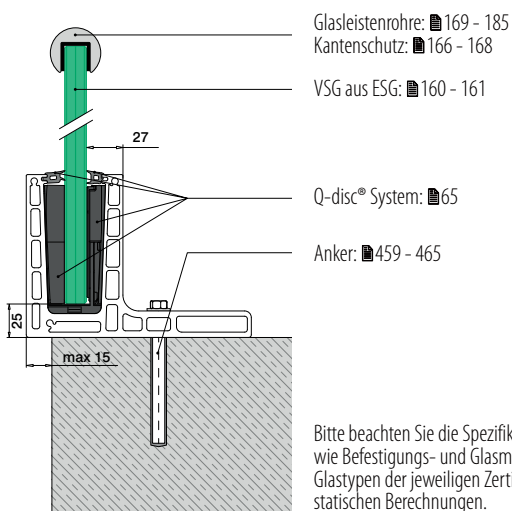

Bitte beachten Sie die Spezifikationen wie Befestigungs- und Glasmaße sowie Glastypen der jeweiligen Zertifikate und statischen Berechnungen.

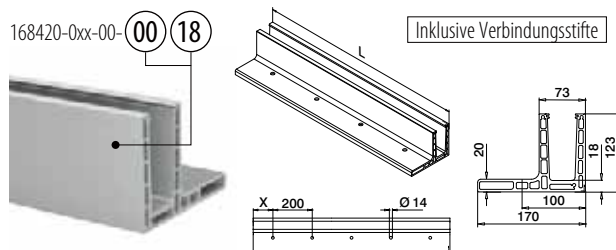

**MOD 8420**

<b>Aluminium</b>	Roh		
	<b>X</b>		
168420-050-00-00	100		L = 5 m
<b>Aluminium</b>	Gebürstet		
<b>OUTDOOR</b>			
168420-025-00-18	50		L = 2,5 m
168420-050-00-18	100		L = 5 m



Internationaler Geschmacksmusterschutz

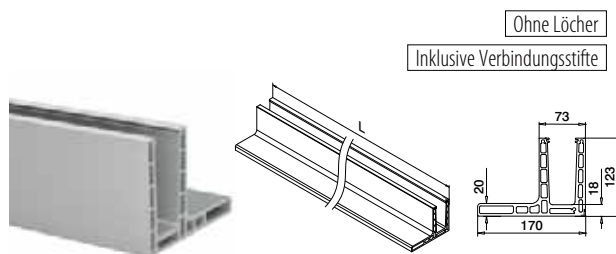

**MOD 8420**

<b>Aluminium</b>	Gebürstet		
<b>OUTDOOR</b>			
168420-050-99-18			L = 5 m



Internationaler Geschmacksmusterschutz

**Q-INFO**

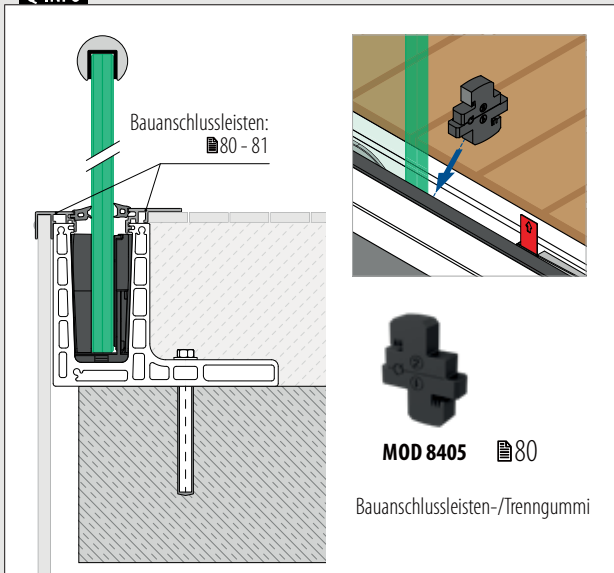

**Q-INFO**

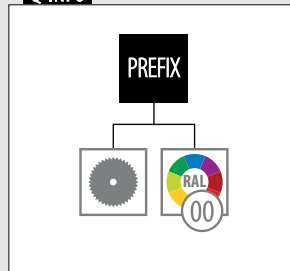

**Q-INFO Aluminium**



**Q-INFO**

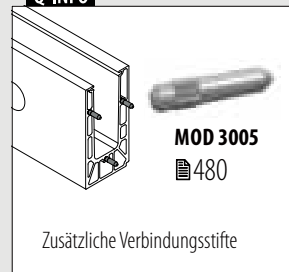

## Ecken zur Bodenmontage

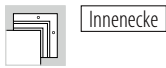

Innenecke

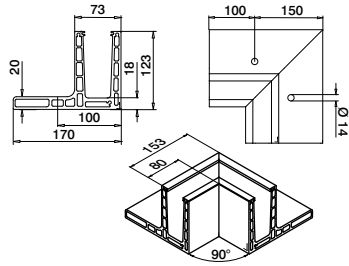

## MOD 8421

**Aluminium** Gebürstet  
**OUTDOOR**

168421-01-18

459 - 465

1



Außenecke

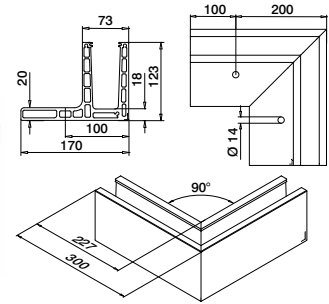

## MOD 8421

**Aluminium** Gebürstet  
**OUTDOOR**

168421-02-18

459 - 465

1



## Endkappen zur Bodenmontage



Links

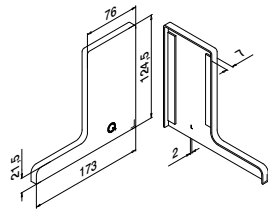

## MOD 8422

**Aluminium** Roh

**Kleband**

168422-01-00

Beigelegt

1

**Aluminium** Gebürstet  
**OUTDOOR**

168422-01-18

Angebracht

1



Rechts

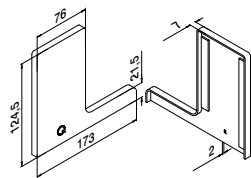

## MOD 8422

**Aluminium** Roh

**Kleband**

168422-02-00

Beigelegt

1

**Aluminium** Gebürstet  
**OUTDOOR**

168422-02-18

Angebracht

1

## Q-INFO MOD 8422

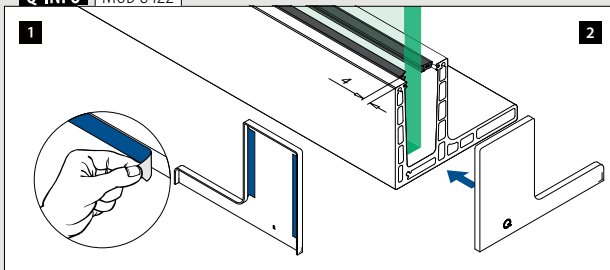



Geländerbasis

**Bodenprofile zur Seitenmontage**

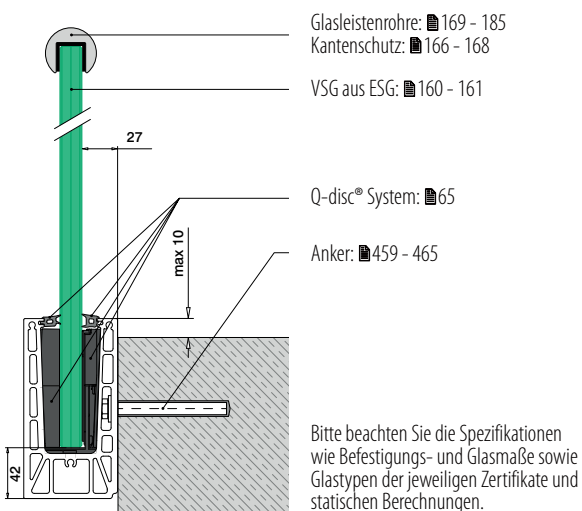

Bitte beachten Sie die Spezifikationen wie Befestigungs- und Glasmaße sowie Glastypen der jeweiligen Zertifikate und statischen Berechnungen.

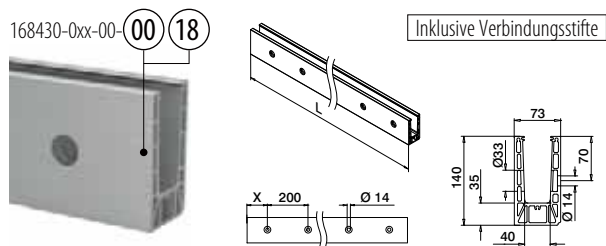

**MOD 8430**

Aluminium	Roh	X		
168430-050-00-00	100	459 - 465	L = 5 m	
Aluminium	Gebürstet	OUTDOOR		
168430-025-00-18	50	459 - 465	L = 2,5 m	
168430-050-00-18	100	459 - 465	L = 5 m	



Internationaler Geschmacksmusterschutz

Geländerbasis

**Ecken zur Seitenmontage**

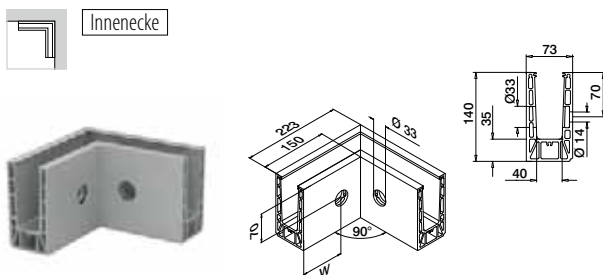

**MOD 8431**

Aluminium	Roh	W		
168431-01-00	100*	459 - 465	1	
Aluminium	Gebürstet	OUTDOOR		
168431-01-18	100*	459 - 465	1	

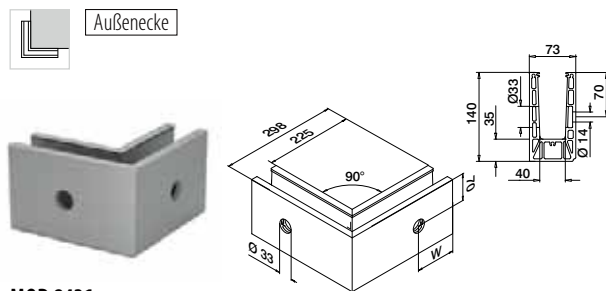

**MOD 8431**

Aluminium	Roh	W		
168431-02-00	100*	459 - 465	1	
Aluminium	Gebürstet	OUTDOOR		
168431-02-18	100*	459 - 465	1	



\*Die Lochposition kann produktionsbedingt abweichen.

**Q-INFO MOD 8430**

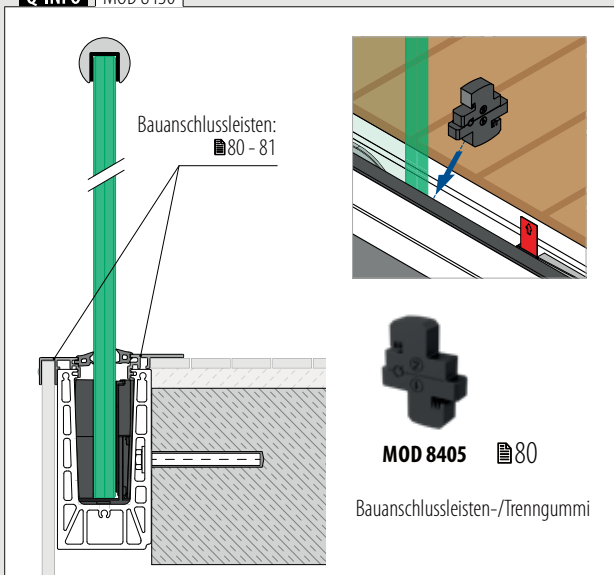

**Q-INFO MOD 8430**

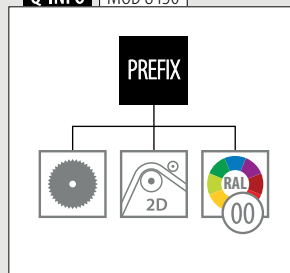

**Q-INFO Aluminium**



**Q-INFO**

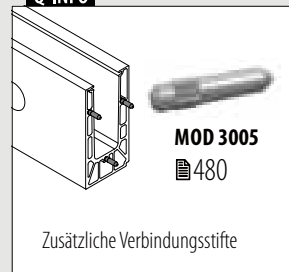

Endkappen zur Seitenmontage

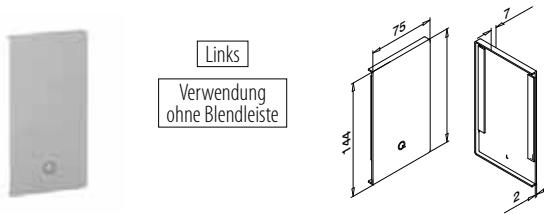

**MOD 8432**

<b>Aluminium</b> Roh	<b>Klebeband</b>	
168432-01-00	Beigelegt	1
<b>Aluminium</b> Gebürstet		
<b>OUTDOOR</b>		
168432-01-18	Angebracht	1

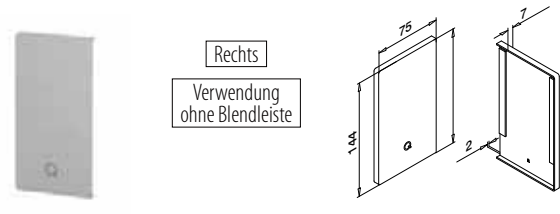

**MOD 8432**

<b>Aluminium</b> Roh	<b>Klebeband</b>	
168432-02-00	Beigelegt	1
<b>Aluminium</b> Gebürstet		
<b>OUTDOOR</b>		
168432-02-18	Angebracht	1

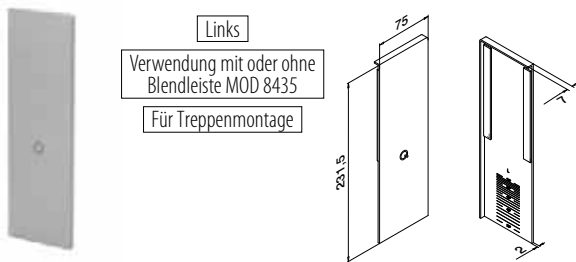

**MOD 8433**

<b>Aluminium</b> Roh	<b>Klebeband</b>	
168433-01-00	Beigelegt	1
<b>Aluminium</b> Gebürstet		
<b>OUTDOOR</b>		
168433-01-18	Angebracht	1

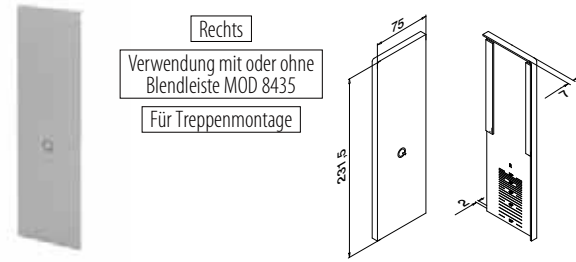

**MOD 8433**

<b>Aluminium</b> Roh	<b>Klebeband</b>	
168433-02-00	Beigelegt	1
<b>Aluminium</b> Gebürstet		
<b>OUTDOOR</b>		
168433-02-18	Angebracht	1



**Q-INFO** | MOD 8432 / 8433

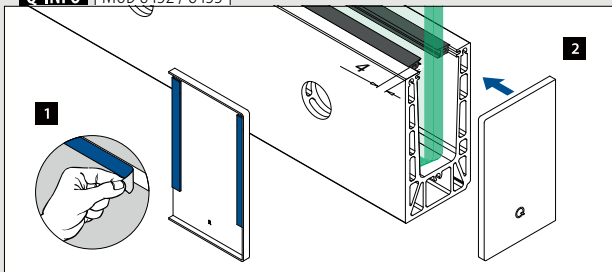

**Q-INFO** | MOD 8433

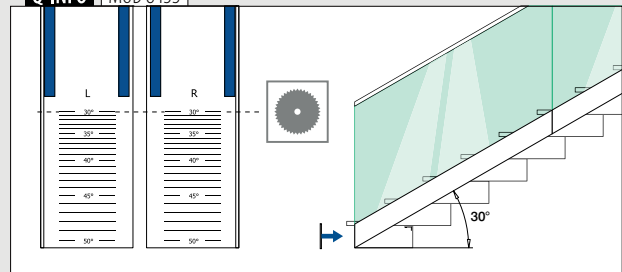

Geländerbasis

Endkappen zur Seitenmontage

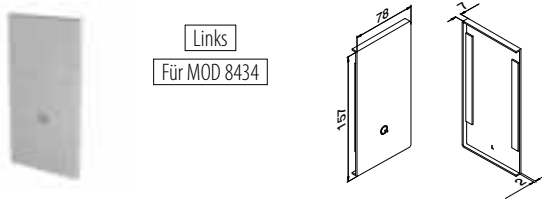

Links  
Für MOD 8434

**MOD 8432**

<b>Aluminium</b>	Roh	<b>Klebeband</b>	
168432-41-00	Beigelegt		1
<b>Aluminium</b>	Gebürstet		
<b>OUTDOOR</b>			
168432-41-18	Angebracht		1

NEW

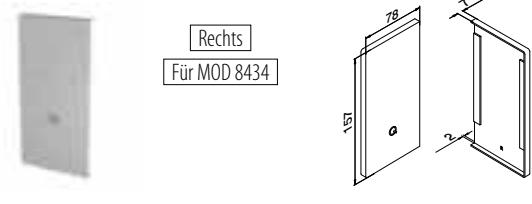

Rechts  
Für MOD 8434

**MOD 8432**

<b>Aluminium</b>	Roh	<b>Klebeband</b>	
168432-42-00	Beigelegt		1
<b>Aluminium</b>	Gebürstet		
<b>OUTDOOR</b>			
168432-42-18	Angebracht		1

NEW

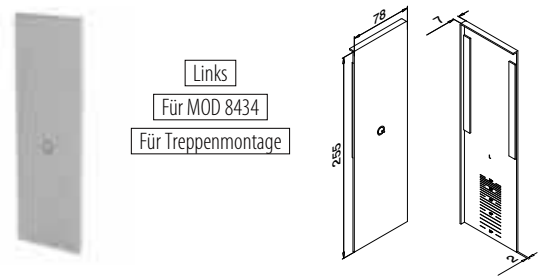

Links  
Für MOD 8434  
Für Treppenmontage

**MOD 8433**

<b>Aluminium</b>	Gebürstet		
<b>OUTDOOR</b>		<b>Klebeband</b>	
168433-41-18	Angebracht		1

NEW

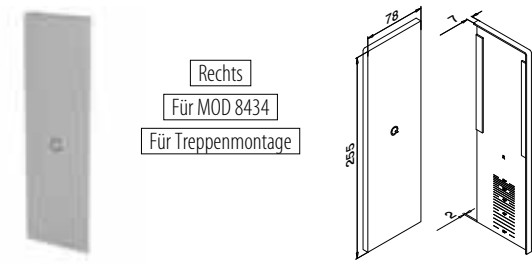

Rechts  
Für MOD 8434  
Für Treppenmontage

**MOD 8433**

<b>Aluminium</b>	Gebürstet		
<b>OUTDOOR</b>		<b>Klebeband</b>	
168433-42-18	Angebracht		1

NEW



**Q-INFO** Aluminium

00

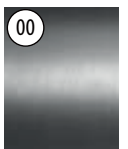

Roh

18

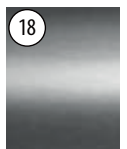

Gebürstet,  
anodisiert

## Drainageleisten zur Seitenmontage

4 Stück für 2,5-Meter-Bodenprofil  
8 Stück für 5-Meter-Bodenprofil

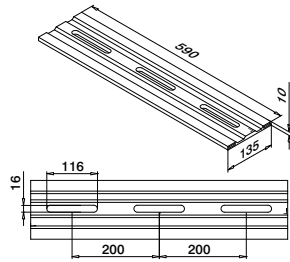

## MOD 8437

**Aluminium** Gebürstet  
**OUTDOOR**

168437-18	4
-----------	---

## Blendstopfen zur Seitenmontage



Verwendung  
ohne Blendeiste

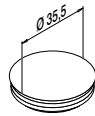

## MOD 8238

**Kunststoff** Aluminium RAL 9006  
**INDOOR**

158238-36	10
-----------	----

## Unterlegscheiben zur Seitenmontage

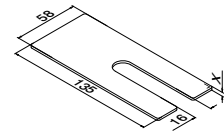

## MOD 8436

**Aluminium** Roh

	X	
168436-001	1	100
168436-002	2	100
168436-003	3	100

## Glas-Stopp



Für Treppenmontage

## MOD 8404

**Zubehör**

208404	1
--------	---

**NEW**

## Q-INFO MOD 8437

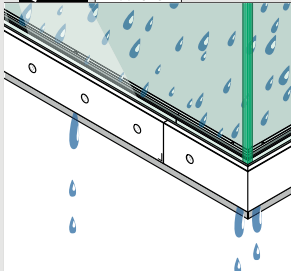

Montage-  
informationen:



[https://q-ne.ws/  
Prime23](https://q-ne.ws/Prime23)



## Q-INFO MOD 8436

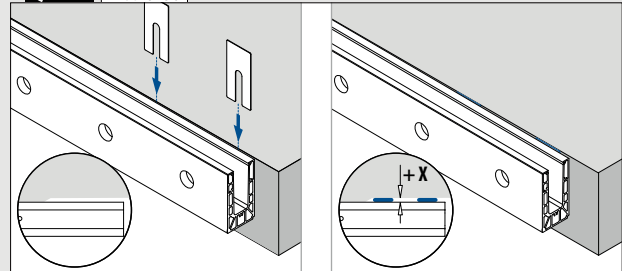

## Q-INFO MOD 8238

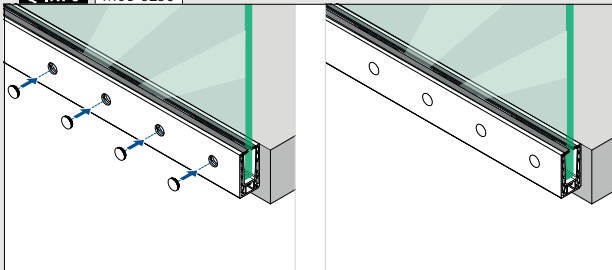

## Q-INFO MOD 8404

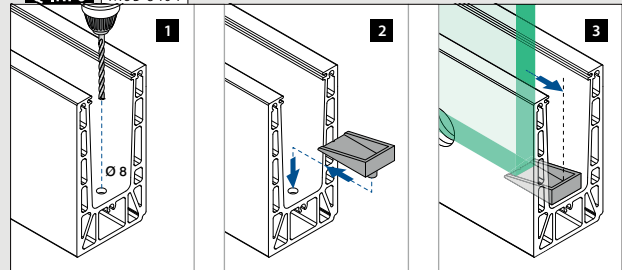



Geländerbasis

Blendleisten zur Seitenmontage

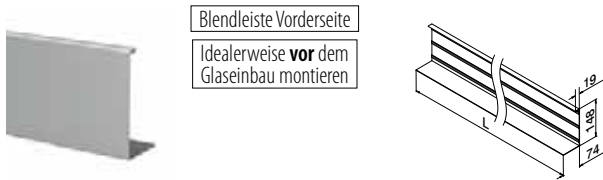

Blendleiste Vorderseite  
Idealerweise **vor** dem Glaseinbau montieren

**MOD 8435**

<b>Aluminium</b> Roh		<b>Klebeband</b>	
SELL OUT	168435-050-00	Nicht inkl.*	L = 5 m
<b>Aluminium</b> Gebürstet			
<b>OUTDOOR</b>			
SELL OUT	168435-050-18	Angebracht	L = 5 m



\*Bestellen Sie MOD 1360 (Klebeband)

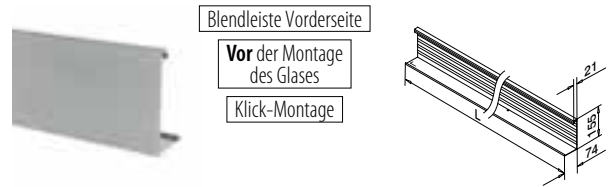

Blendleiste Vorderseite  
**Vor** der Montage des Glases  
Klick-Montage

**MOD 8434**

<b>Aluminium</b> Roh		<b>Klebeband</b>	
	168434-050-00		L = 5 m
<b>Aluminium</b> Gebürstet			
<b>OUTDOOR</b>			
	168434-050-18		L = 5 m



Zubehör

Acrylat-Klebeband



**MOD 1360**

<b>Zubehör</b>					
	<b>Q</b>	<b>W</b>	<b>L</b>		
201360	Q-53	9	33 m (für 11 m Blendleiste)		1

**Q-INFO** MOD 8435-050-00 / 1360

Montage-Informationen:



<https://q-ne.ws/Prime23>

**Q-INFO** Aluminium

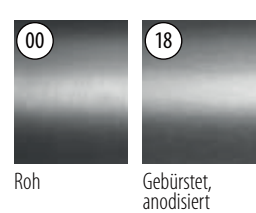

Roh

Gebürstet, anodisiert



Nur solange der Vorrat reicht.

**Q-INFO** MOD 8435

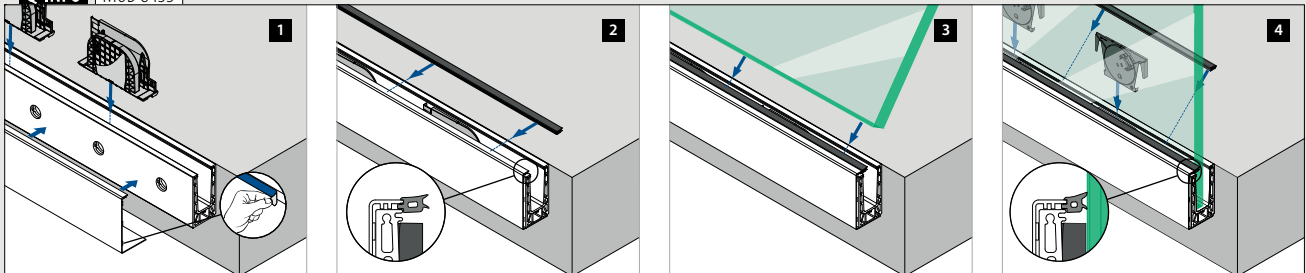

**Q-INFO** MOD 8434

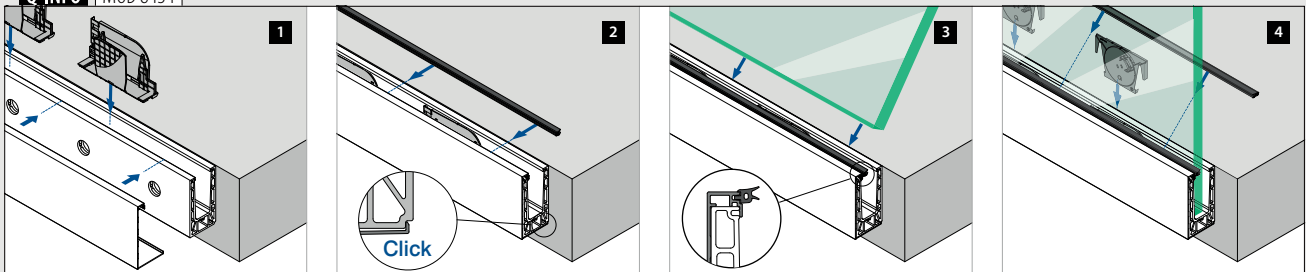

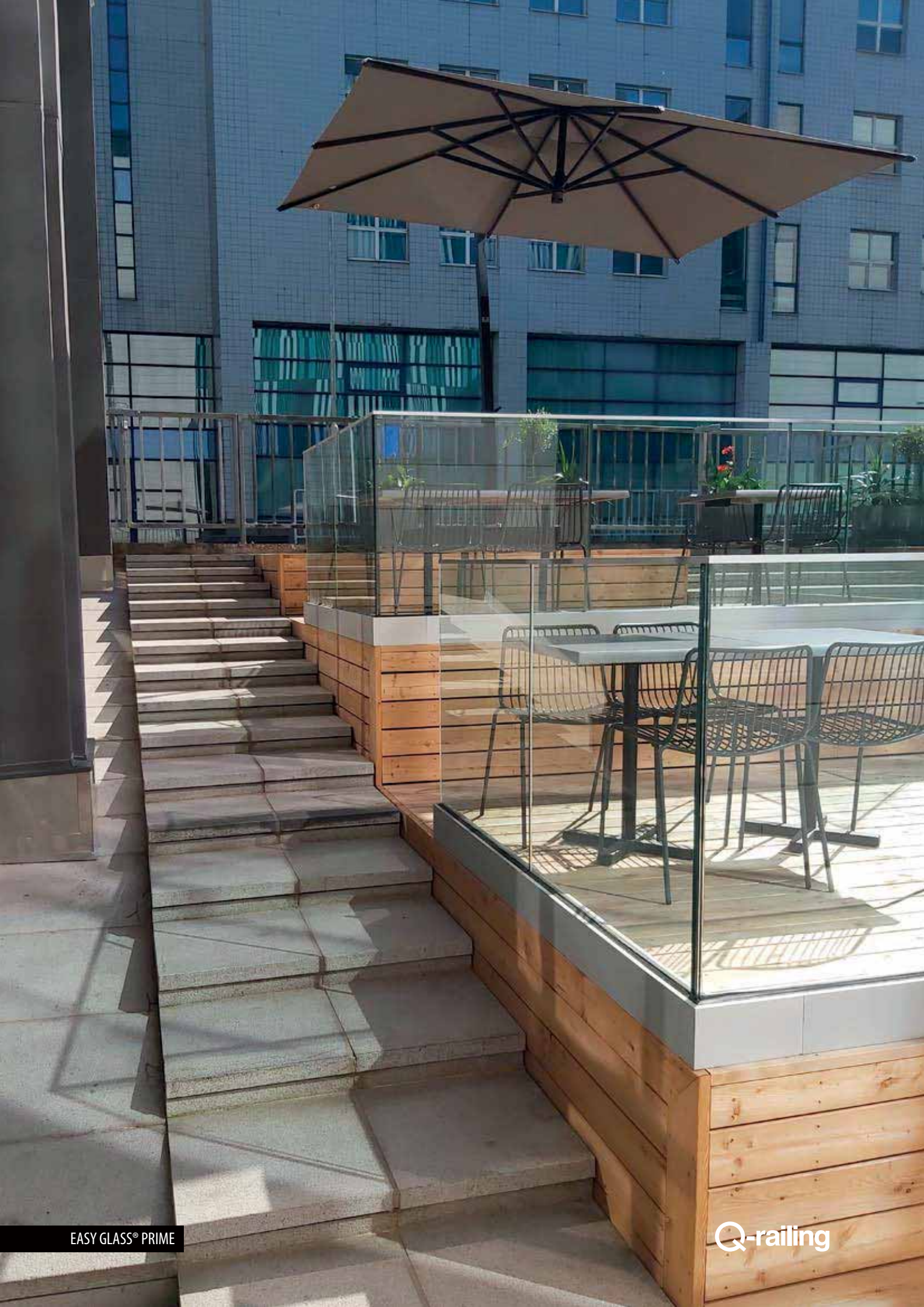



Bodenprofile zur Seitenmontage

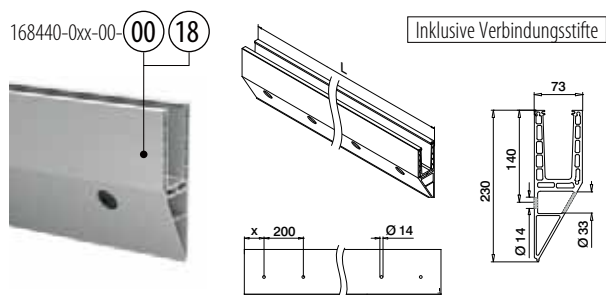
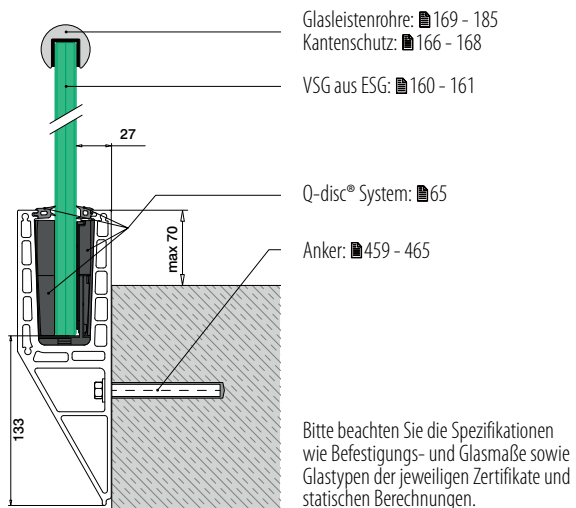

MOD 8440

Aluminium	Roh	X		
168440-050-00-00	100		459 - 465	L = 5 m
Aluminium	Gebürstet			
OUTDOOR				
168440-025-00-18	50		459 - 465	L = 2,5 m
168440-050-00-18	100		459 - 465	L = 5 m



Internationaler Geschmacksmusterschutz

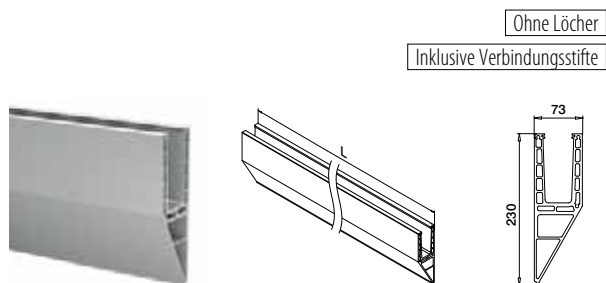

MOD 8440

Aluminium	Gebürstet		
OUTDOOR			
168440-050-99-18			L = 5 m



Internationaler Geschmacksmusterschutz

Q-INFO

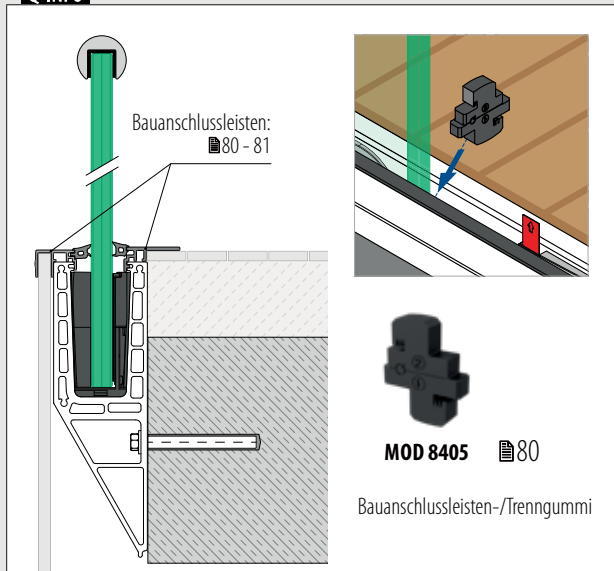

Q-INFO

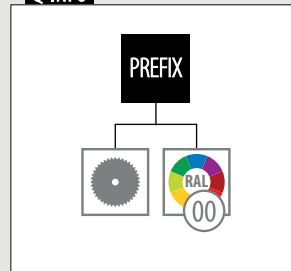

Q-INFO Aluminium



Q-INFO



## Ecken zur Seitenmontage

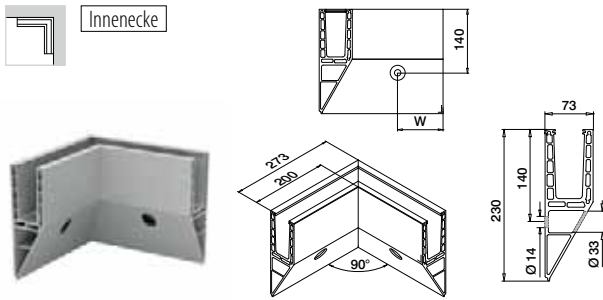

## MOD 841

<b>Aluminium</b>	Gebürstet			
<b>OUTDOOR</b>	<b>W</b>			
168441-01-18	100*	459 - 465	1	

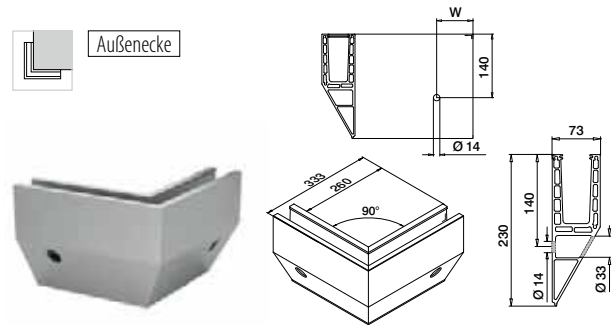

## MOD 841

<b>Aluminium</b>	Gebürstet			
<b>OUTDOOR</b>	<b>W</b>			
168441-02-18	100*	459 - 465	1	



\*Die Lochposition kann produktionsbedingt abweichen.

## Endkappen zur Seitenmontage

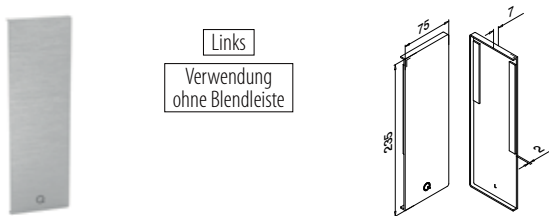

Links  
Verwendung  
ohne Blendleiste

## MOD 842

<b>Aluminium</b>	Roh			
	<b>Kleband</b>			
168442-01-00	Beigelegt		1	
<b>Aluminium</b>	Gebürstet			
<b>OUTDOOR</b>				
168442-01-18	Angebracht		1	

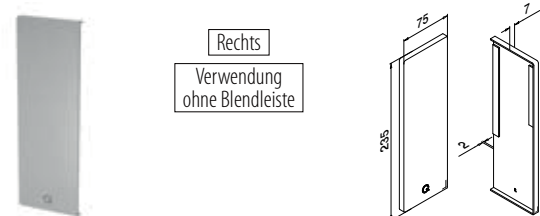

Rechts  
Verwendung  
ohne Blendleiste

## MOD 842

<b>Aluminium</b>	Roh			
	<b>Kleband</b>			
168442-02-00	Beigelegt		1	
<b>Aluminium</b>	Gebürstet			
<b>OUTDOOR</b>				
168442-02-18	Angebracht		1	

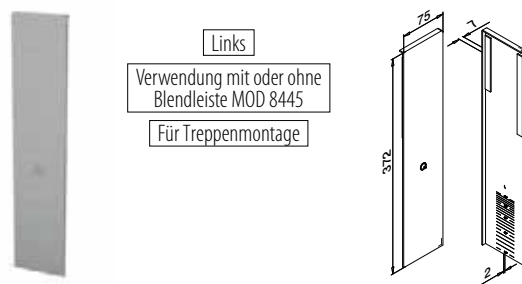

Links  
Verwendung mit oder ohne  
Blendleiste MOD 8445  
Für Treppenmontage

## MOD 843

<b>Aluminium</b>	Gebürstet			
	<b>Kleband</b>			
168443-01-18	Angebracht		1	

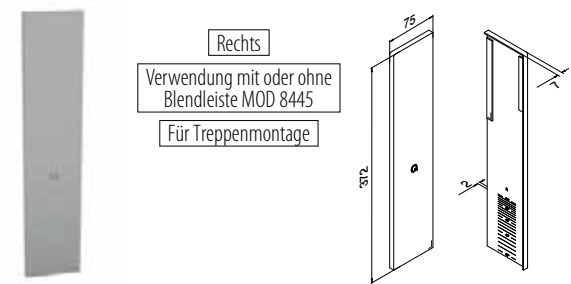

Rechts  
Verwendung mit oder ohne  
Blendleiste MOD 8445  
Für Treppenmontage

## MOD 843

<b>Aluminium</b>	Gebürstet			
	<b>Kleband</b>			
168443-02-18	Angebracht		1	



## Q-INFO | MOD 8442 / 8443

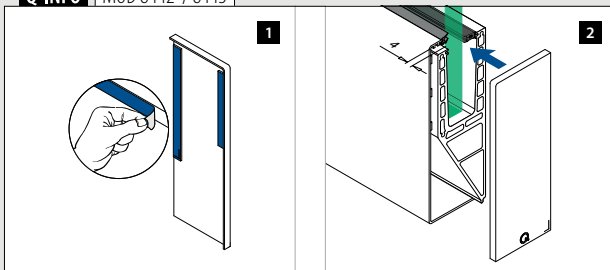

## Q-INFO | MOD 8443

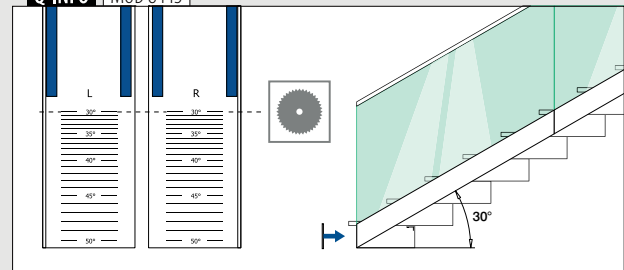



Geländerbasis

Endkappen zur Seitenmontage



Links  
Für MOD 8444

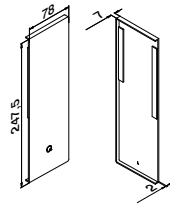

Rechts  
Für MOD 8444

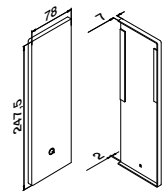

MOD 8442

<b>Aluminium</b>	Roh	<b>Klebeband</b>	
168442-41-00	Beigelegt		1
<b>Aluminium</b>	Gebürstet	<b>OUTDOOR</b>	
168442-41-18	Angebracht		1

NEW

MOD 8442

<b>Aluminium</b>	Roh	<b>Klebeband</b>	
168442-42-00	Beigelegt		1
<b>Aluminium</b>	Gebürstet	<b>OUTDOOR</b>	
168442-42-18	Angebracht		1

NEW



Links  
Für MOD 8444  
Für Treppenmontage

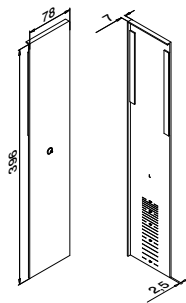

Rechts  
Für MOD 8444  
Für Treppenmontage

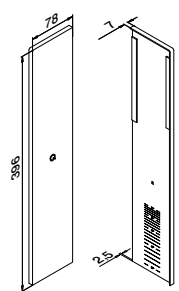

MOD 8443

<b>Aluminium</b>	Gebürstet	<b>OUTDOOR</b>	<b>Klebeband</b>	
168443-41-18	Angebracht			1

NEW



MOD 8443

<b>Aluminium</b>	Gebürstet	<b>OUTDOOR</b>	<b>Klebeband</b>	
168443-42-18	Angebracht			1

NEW



Geländerbasis

Glas-Stopp



Für Treppenmontage

MOD 8404

<b>Zubehör</b>		
208404		1

NEW

Q-INFO | MOD 8404

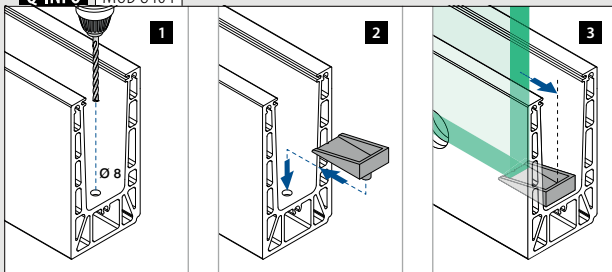

Q-INFO | Aluminium

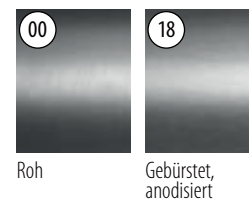

Blendleisten zur Seitenmontage

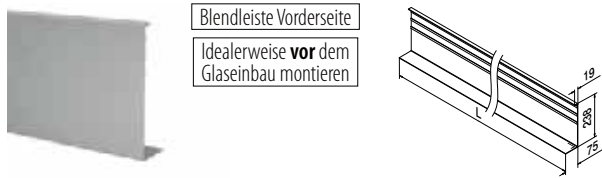

**MOD 8445**

<b>Aluminium</b>	Roh		
		<b>Klebeband</b>	
<b>SELL OUT</b>	168445-050-00	Nicht inkl.*	L = 5 m
<b>Aluminium</b>	Gebürstet		
		<b>OUTDOOR</b>	
<b>SELL OUT</b>	168445-050-18	Angebracht	L = 5 m



\*Bestellen Sie MOD 1360 (Klebeband)

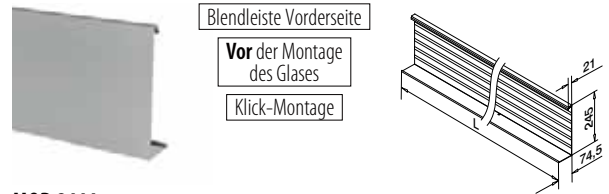

**MOD 8444**

<b>Aluminium</b>	Roh		
		<b>Klebeband</b>	
	168444-050-00		L = 5 m
<b>Aluminium</b>	Gebürstet		
		<b>OUTDOOR</b>	
	168444-050-18		L = 5 m



Zubehör

Acrylat-Klebeband



**MOD 1360**

<b>Zubehör</b>					
	<b>Q</b>	<b>W</b>	<b>L</b>		
201360	Q-53	9	33 m (für 11 m Blendleiste)	1	

**Q-INFO** MOD 8445-050-00 / 1360

Montage-Informationen:



**SELL OUT** Nur solange der Vorrat reicht.

**Q-INFO** MOD 8445

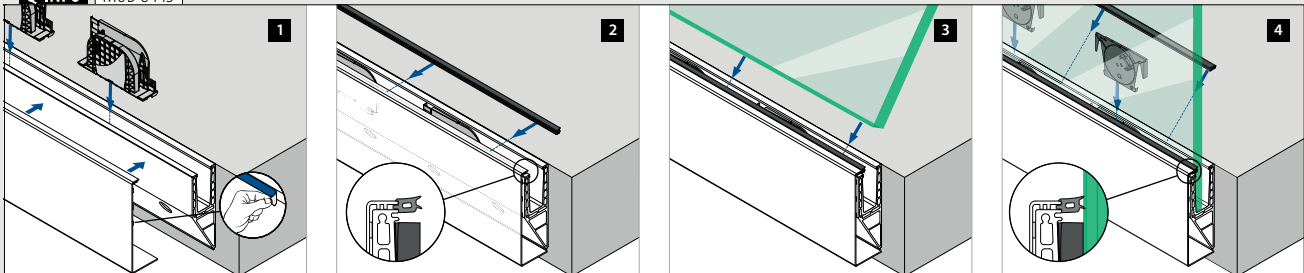

**Q-INFO** MOD 8444

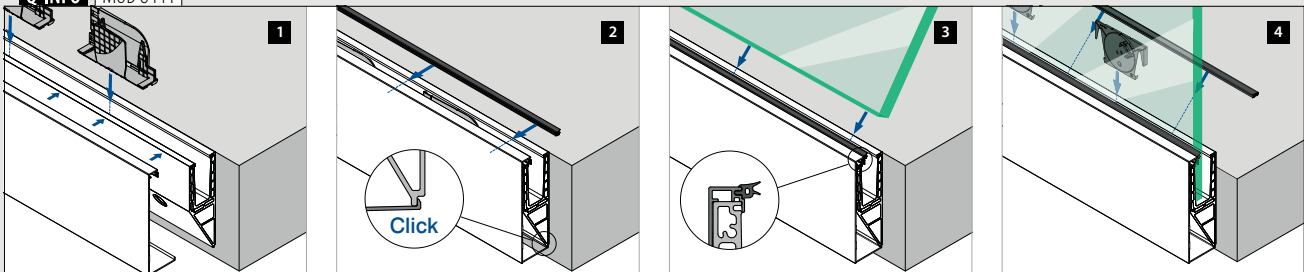

Geländerbasis

Bauanschlussleisten

Für alle Prime-Profile

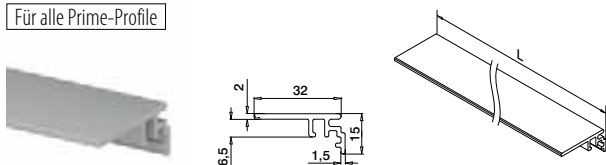

MOD 6973

<b>Aluminium</b>	Roh	
166973-50-00		L = 5 m
<b>Aluminium</b>	Gebürstet	
<b>OUTDOOR</b>		
166973-50-18		L = 5 m

PREFIX

Für Prime **Boden-**  
montage-Profile

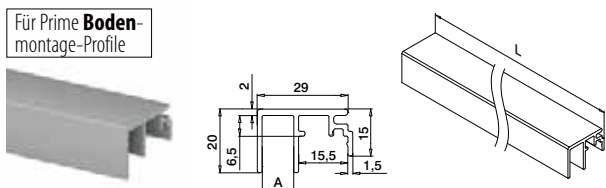

MOD 6970

<b>Aluminium</b>	Roh	
	<b>A</b>	
166970-010-50-00	10	L = 5 m
<b>Aluminium</b>	Gebürstet	
<b>OUTDOOR</b>		
166970-010-50-18	10	L = 5 m

PREFIX

Für alle Prime-Profile

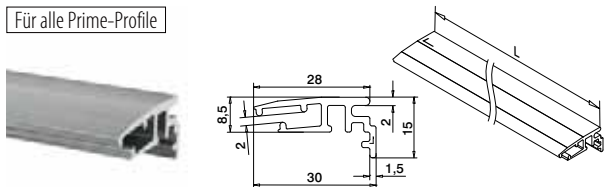

MOD 6979

<b>Aluminium</b>	Roh	
166979-002-50-00		L = 5 m
<b>Aluminium</b>	Gebürstet	
<b>OUTDOOR</b>		
166979-002-50-18		L = 5 m

NEW

PREFIX

Für Prime **Boden-**  
montage-Profile

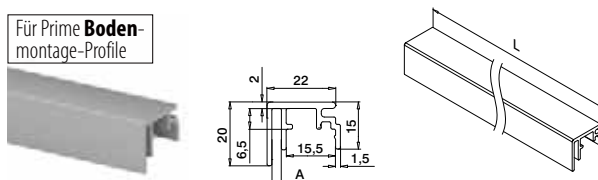

MOD 6970

<b>Aluminium</b>	Roh	
	<b>A</b>	
166970-003-50-00	3	L = 5 m
<b>Aluminium</b>	Gebürstet	
<b>OUTDOOR</b>		
166970-003-50-18	3	L = 5 m

PREFIX

Für Prime **Boden-**  
montage-Profile

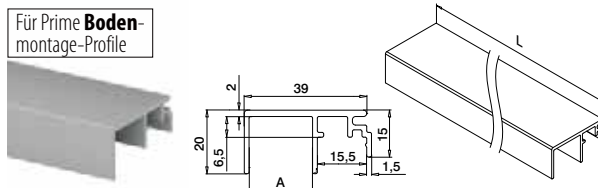

MOD 6970

<b>Aluminium</b>	Roh	
	<b>A</b>	
166970-020-50-00	20	L = 5 m
<b>Aluminium</b>	Gebürstet	
<b>OUTDOOR</b>		
166970-020-50-18	20	L = 5 m

PREFIX

Geländerbasis

Bauanschlussleisten-/Trenngummi

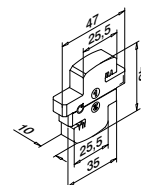

MOD 8405

<b>Zubehör</b>	
208405-010	5



Q-INFO Aluminium



Q-INFO

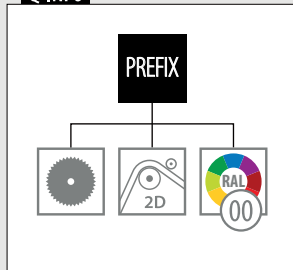

Q-INFO MOD 8405

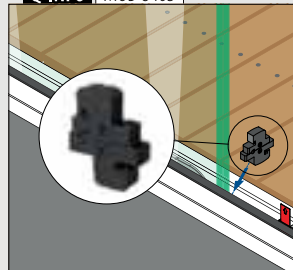

Bauanschlussleisten

Für alle Prime-Profile

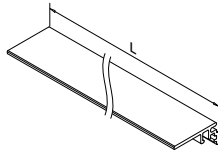
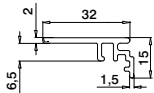

**MOD 6973**

<b>Aluminium</b>	Roh		
166973-50-00		L = 5 m	
<b>Aluminium</b>	Gebürstet		
<b>OUTDOOR</b>			
166973-50-18		L = 5 m	

PREFIX

Für Prime **F-, Seiten-**montage- und **Y-**Profile

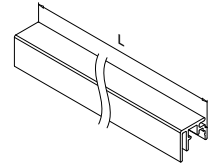
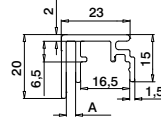

**MOD 6974**

<b>Aluminium</b>	Roh	<b>A</b>	
166974-003-50-00		3	L = 5 m
<b>Aluminium</b>	Gebürstet		
<b>OUTDOOR</b>			
166974-003-50-18		3	L = 5 m

PREFIX

Für Prime **F-, Seiten-**montage- und **Y-**Profile

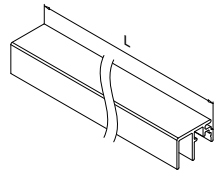
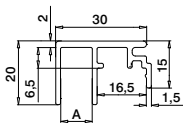

**MOD 6974**

<b>Aluminium</b>	Roh	<b>A</b>	
166974-010-50-00		10	L = 5 m
<b>Aluminium</b>	Gebürstet		
<b>OUTDOOR</b>			
166974-010-50-18		10	L = 5 m

PREFIX

Für Prime **F-, Seiten-**montage- und **Y-**Profile

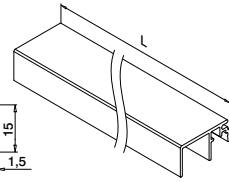
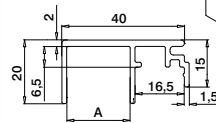

**MOD 6974**

<b>Aluminium</b>	Roh	<b>A</b>	
166974-020-50-00		20	L = 5 m
<b>Aluminium</b>	Gebürstet		
<b>OUTDOOR</b>			
166974-020-50-18		20	L = 5 m

PREFIX

**Q-INFO** MOD 6979

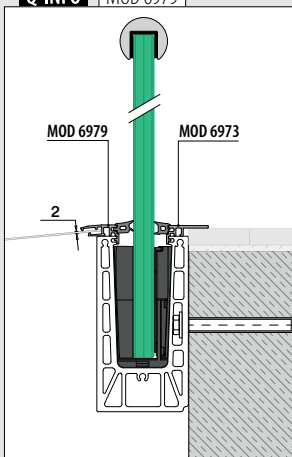

**Q-INFO** MOD 6970 / 6973

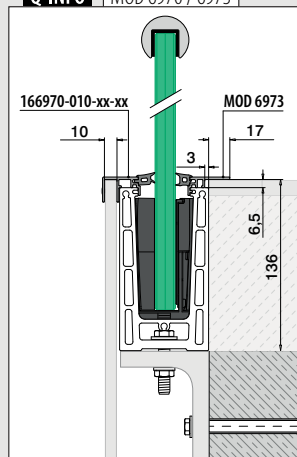

**Q-INFO** MOD 6974 / 6973

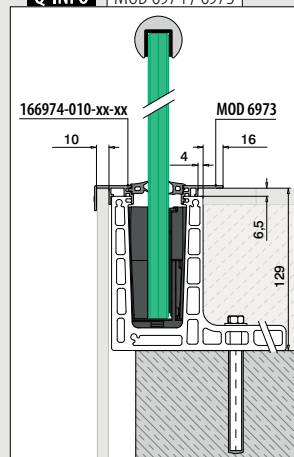

**Q-INFO** MOD 6974 / 6973

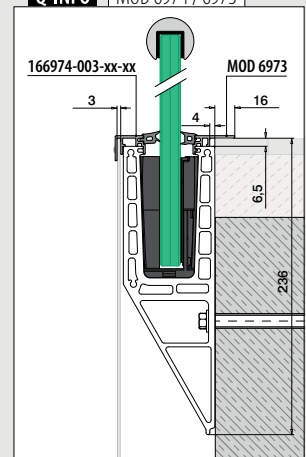





**Beanspruchung:** Hoch und besonders hoch  
**Verwendung:** Innen- und Außenbereich  
**Montage:** Boden-, In-Boden- und Seitenmontage  
**Anwendung:** Balkone, Galerien, Wege, Abtrennungen und Treppen  
**Material:** Aluminium (gebürstet anodisiert und roh)  
**Glasstärke:** 21,52 bis 33,04 mm

Finden Sie alle Informationen zu Easy Glass Strong online:



<https://q-ne.ws/Strong23>

# EASY GLASS<sup>®</sup> STRONG



reddot winner 2020  
innovative product



## Ein Kraftpaket einfach installiert

Unser neues Kraftpaket mit dem revolutionären Q-disc® System heißt Easy Glass® Strong. Die Kombination aus Stärke und Funktionalität macht dieses System ideal für öffentliche Gebäude wie Stadien, Flughäfen oder Einkaufszentren. Dank des integrierten Q-disc Systems wird die Montage deutlich beschleunigt: Befestigen Sie das Bodenprofil am Boden, setzen Sie das Glas ein und fixieren Sie es – mit einer Handdrehung – im Profil. Mit der justierbaren Variante des Q-disc Systems lassen sich die einzelnen Glasscheiben in der Vertikalen ausrichten. Natürlich finden Sie in dieser Serie weitere passende Komponenten, um Ihr Geländerprojekt zu realisieren.

### Easy Glass® Strong

Max. Holmlast (kN/m)

DE

2,0

STATISCHE  
BERECHNUNG  
DIN18008

AbP  
BALAST  
GEPRÜFT

Bitte beachten Sie die Spezifikationen wie Befestigungs- und Glasmaße sowie Glastypen der jeweiligen Zertifikate.

### International getestet/berechnet/zertifiziert:



- 1 Mit dem justierbaren Q-disc System können Sie die Glasscheiben um bis zu 0,3° in der Vertikalen ausrichten.
- 2 Mit einem Klickgeräusch signalisiert die Q-disc die korrekte Installation.
- 3 Auch geeignet für 3-Scheiben-Sicherheitsglas (Glasstärken bis zu 33,04 mm).

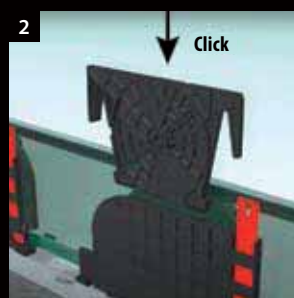
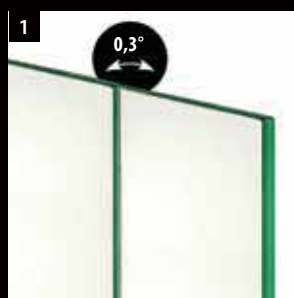

## EASY GLASS® STRONG MONTAGEOPTIONEN

### Strong

#### Bodenmontage

- Auch für In-Bodenmontage geeignet

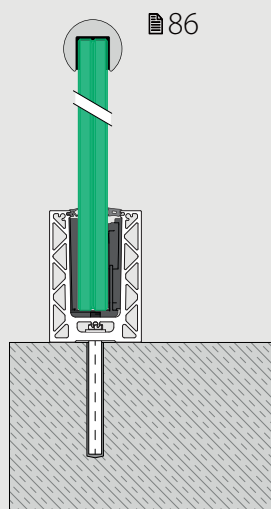

86

### Strong

#### Seitenmontage

- Auch zur Montage an der Innenseite von Aufmauerungen
- Bodenprofil-Blendleiste erhältlich

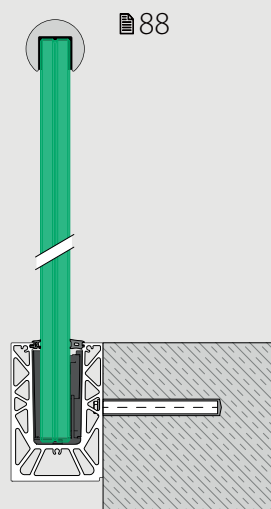

88

COMING SOON

### F und Y Bodenprofile

#### Strong F

#### Bodenmontage

- Für Rohfußböden
- Kann direkt an oder über der Bodenkante angebracht werden

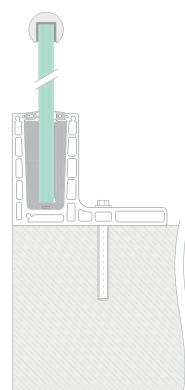

#### Strong Y

#### Seitenmontage

- Für Rohfußböden
- Kann direkt an oder über der Bodenkante angebracht werden

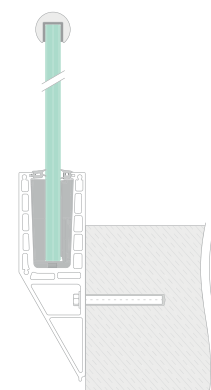



# JUSTIERBARES Q-DISC® SYSTEM SCHIEBEN UND AUSRICHTEN!



## SO FUNKTIONIERT'S

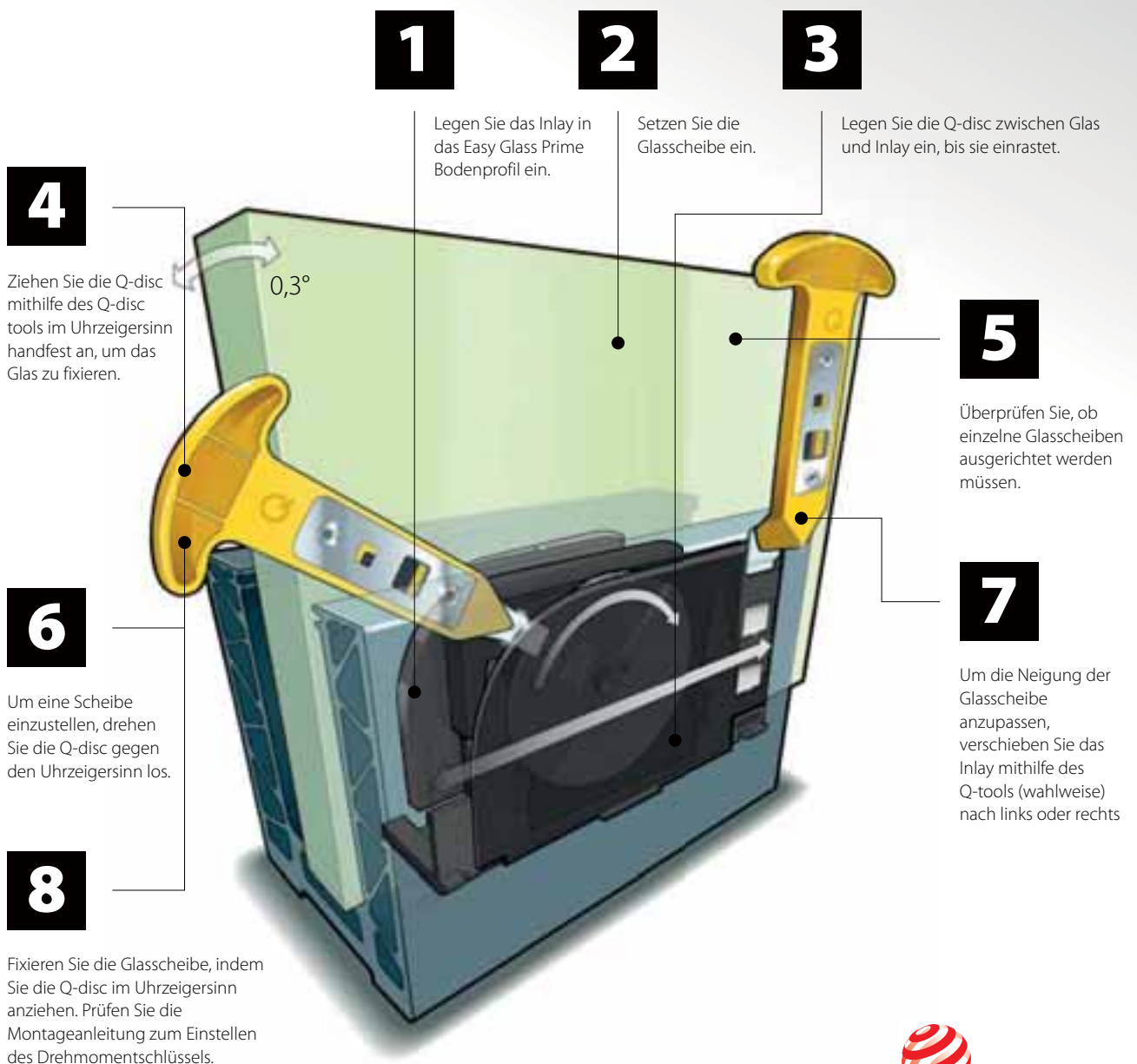

reddot winner 2020  
innovative product



Q-disc® System (Gummi, Inlay und Q-disc®)

Glasklemmung und -justierung

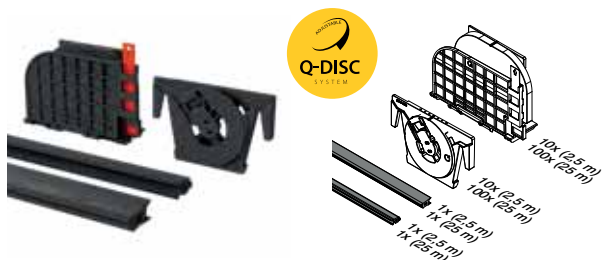

MOD 8601

Zubehör

Für laminiertes Glas	T	
208601-025-22	21,52	L = 2,5 m
208601-025-26	25,52	L = 2,5 m
208601-025-32	31,52	L = 2,5 m
208601-025-34	33,04	L = 2,5 m
208601-250-22	21,52	L = 25 m
208601-250-26	25,52	L = 25 m
208601-250-32	31,52	L = 25 m
208601-250-34	33,04	L = 25 m



Internationaler Geschmacksmusterschutz

Einzelne Gummis



MOD 8207

Zubehör

208207-250-00	L = 25 m



MOD 8607 / 8207

Zubehör

Für laminiertes Glas	T	
208607-250-22	21,52	L = 25 m
208607-250-26	25,52	L = 25 m
208207-250-15	31,52	L = 25 m
208207-250-18	33,04	L = 25 m



Q-disc®- und Inlay-Werkzeug



MOD 1000

Zubehör

	Q	
201000	Q-84	1

Q-disc®-Sets

Glasklemmung und -justierung



MOD 8609

Zubehör

	T	
208609-22	21,52	5
208609-26	25,52	5
208609-32	31,52	5
208609-34	33,04	5



Q-INFO MOD 1000

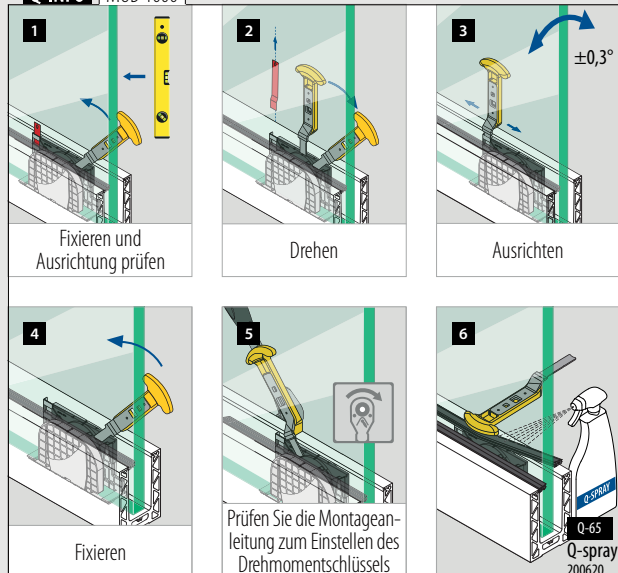

Q-INFO

Installationsblech

MOD 1002

482





Geländerbasis

**Bodenprofile zur Bodenmontage**

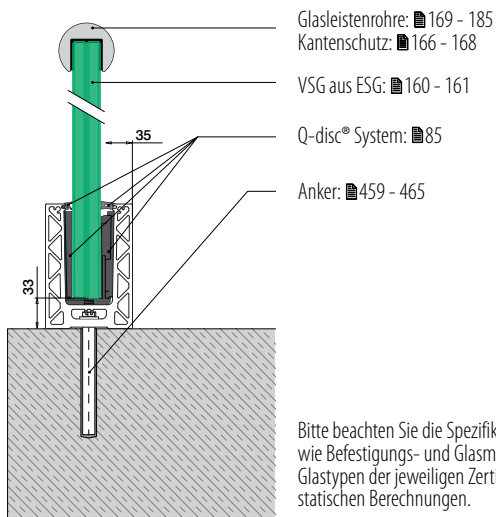

Bitte beachten Sie die Spezifikationen wie Befestigungs- und Glasmaße sowie Glastypen der jeweiligen Zertifikate und statischen Berechnungen.

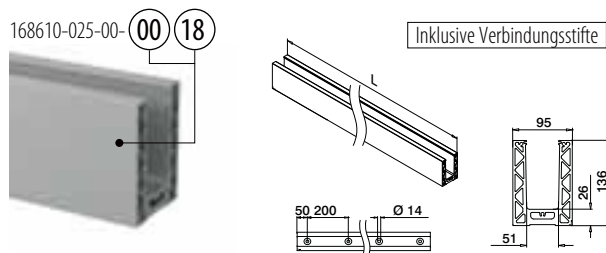

**MOD 8610**

<b>Aluminium</b>	Roh		
168610-025-00-00	459 - 465		L = 2,5 m
<b>Aluminium</b>	Gebürstet		
<b>OUTDOOR</b>			
168610-025-00-18	459 - 465		L = 2,5 m



Geländerbasis

**Ecken zur Bodenmontage**

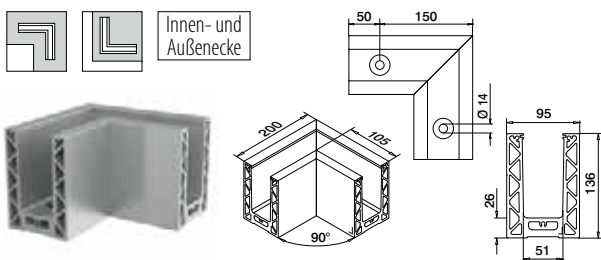

**MOD 8611**

<b>Aluminium</b>	Roh		
168611-00-00	459 - 465		1
<b>Aluminium</b>	Gebürstet		
<b>OUTDOOR</b>			
168611-00-18	459 - 465		1



Internationaler Geschmacksmusterschutz

**Q-INFO MOD 8610**

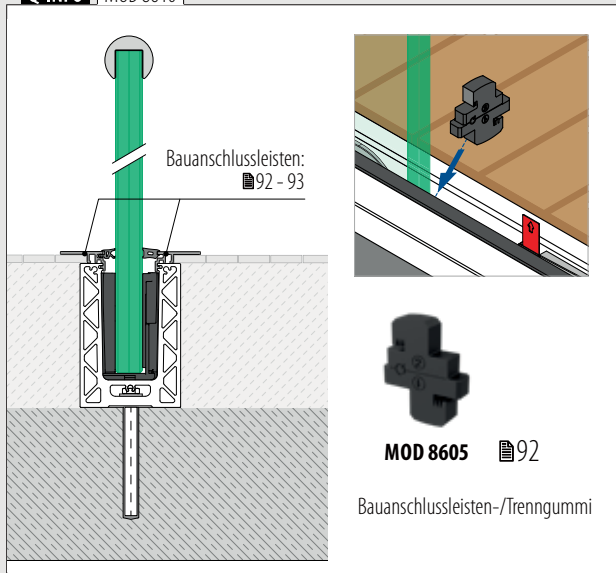

**Q-INFO MOD 8610**

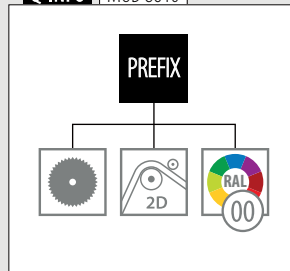

**Q-INFO Aluminium**



**Q-INFO**

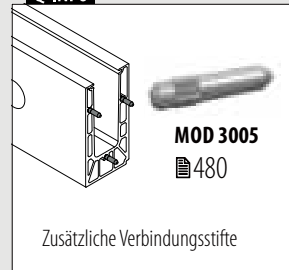

## Endkappen zur Bodenmontage



## MOD 8612

<b>Aluminium</b>	Roh		
		<b>Klebeband</b>	
168612-00-00	Beigelegt		1
<b>Aluminium</b>	Gebürstet		
		<b>OUTDOOR</b>	
168612-00-18	Angebracht		1

NEW

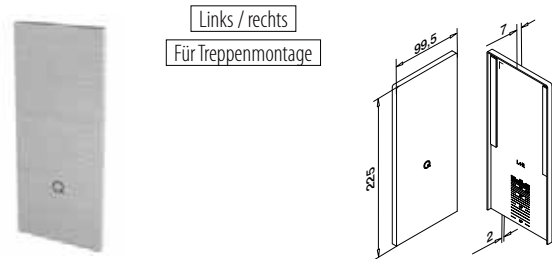

## MOD 8613

<b>Aluminium</b>	Roh		
		<b>Klebeband</b>	
168613-00-00	Beigelegt		1
<b>Aluminium</b>	Gebürstet		
		<b>OUTDOOR</b>	
168613-00-18	Angebracht		1

NEW



## Unterlegscheiben zur Bodenmontage

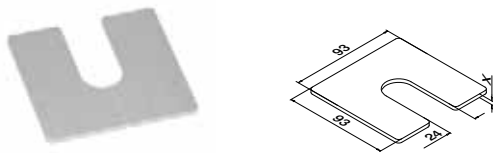

## MOD 8616

<b>Aluminium</b>	Roh		
		<b>X</b>	
168616-001		1	100
168616-002		2	100
168616-003		3	100

NEW

## Drainageleisten zur Bodenmontage

4 Stück für 2,5-Meter-Bodenprofil

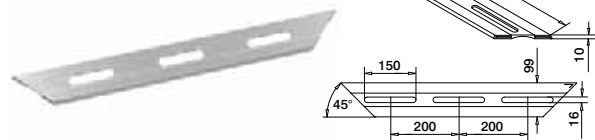

## MOD 8617

<b>Aluminium</b>	Gebürstet		
		<b>OUTDOOR</b>	
168617-18			4

NEW

## Q-INFO MOD 8612

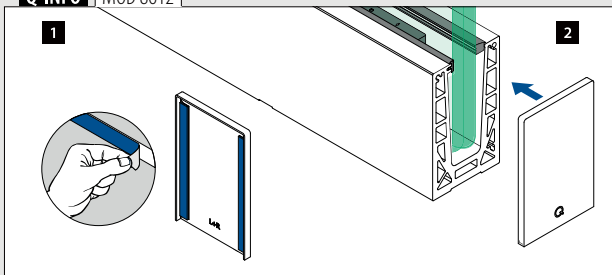

## Q-INFO MOD 8616

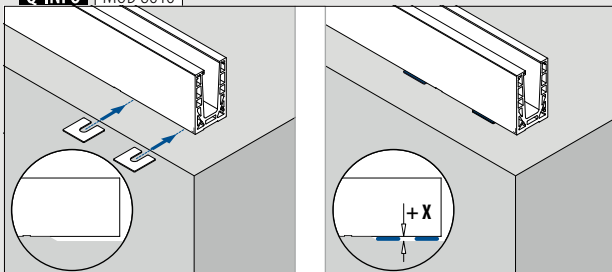

## Q-INFO MOD 8613

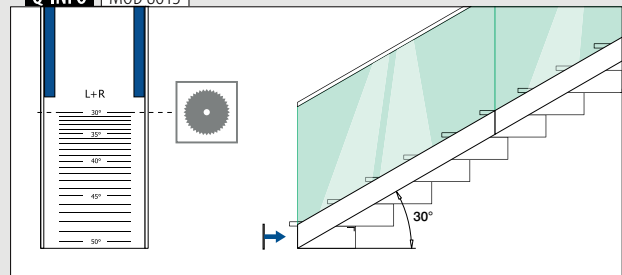

## Q-INFO MOD 8617

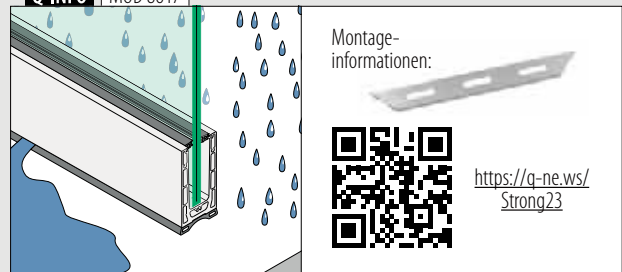

<https://q-ne.ws/Strong23>

Geländerbasis

Bodenprofile zur Seitenmontage

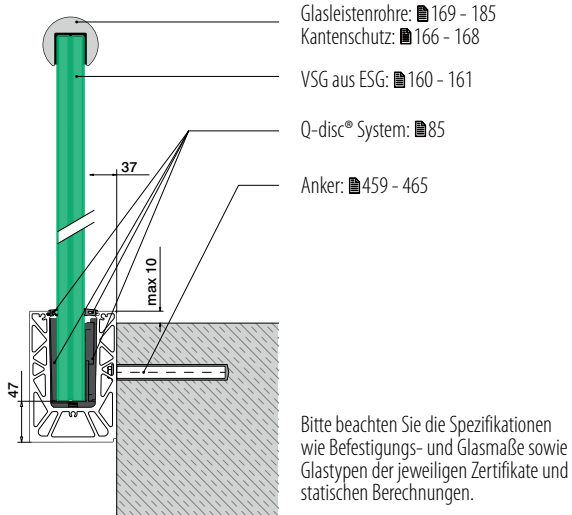

- Glasleistenrohre: ■ 169 - 185
- Kantenschutz: ■ 166 - 168
- VSG aus ESG: ■ 160 - 161
- Q-disc® System: ■ 85
- Anker: ■ 459 - 465

Bitte beachten Sie die Spezifikationen wie Befestigungs- und Glasmaße sowie Glasstypen der jeweiligen Zertifikate und statischen Berechnungen.

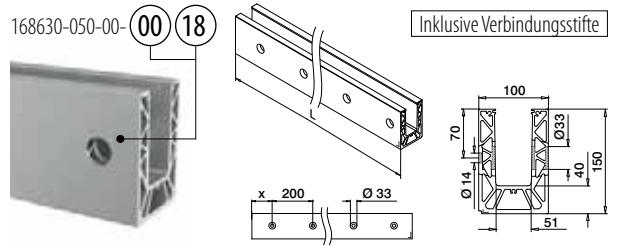

MOD 8630

Aluminium	Roh	X		
168630-025-00-00	100	■ 459 - 465	L = 2,5 m	
Aluminium	Gebürstet			
168630-025-00-18	100	■ 459 - 465	L = 2,5 m	



Internationaler Geschmacksmusterschutz

Geländerbasis

Ecken zur Seitenmontage

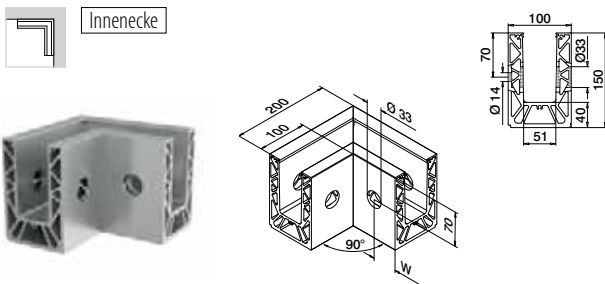

MOD 8631

Aluminium	Roh	W		
168631-01-00	50*	■ 459 - 465	1	
Aluminium	Gebürstet			
168631-01-18	50*	■ 459 - 465	1	

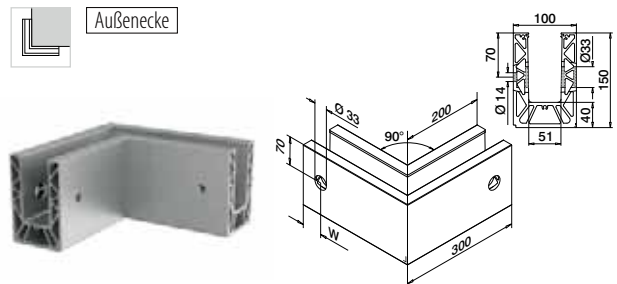

MOD 8631

Aluminium	Roh	W		
168631-02-00	50*	■ 459 - 465	1	
Aluminium	Gebürstet			
168631-02-18	50*	■ 459 - 465	1	



\*Die Lochposition kann produktionsbedingt abweichen.

Q-INFO MOD 8630

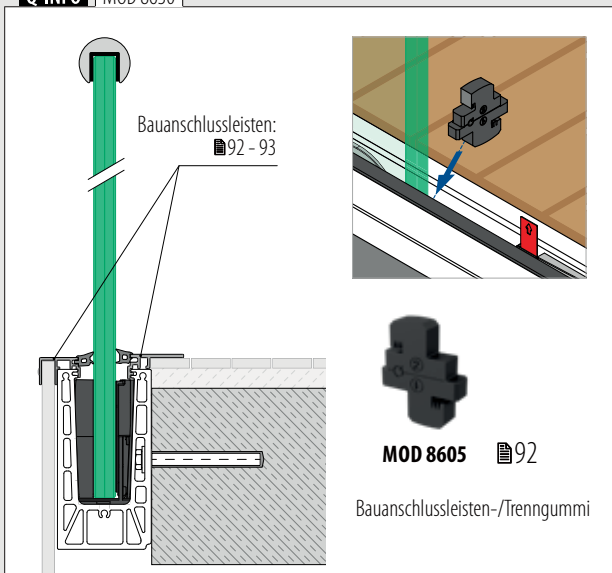

Q-INFO MOD 8630

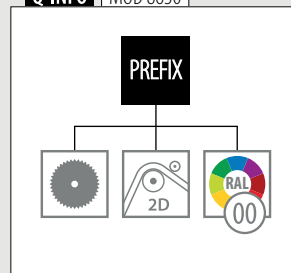

Q-INFO Aluminium



Q-INFO



## Endkappen zur Seitenmontage

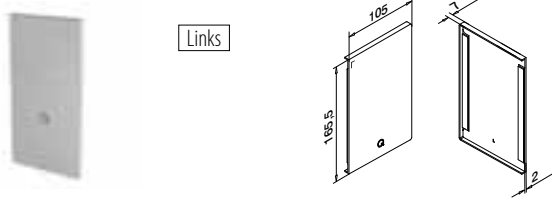

Links

**MOD 8632**

<b>Aluminium</b>	Roh		
	<b>Klebeband</b>		
168632-41-00	Beigelegt	1	
<b>Aluminium</b>	Gebürstet		
<b>OUTDOOR</b>			
168632-41-18	Angebracht	1	

NEW

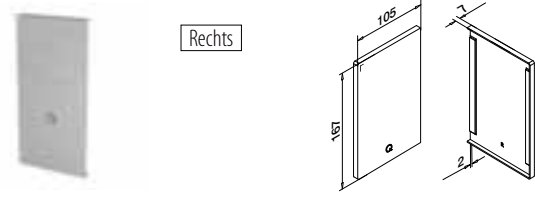

Rechts

**MOD 8632**

<b>Aluminium</b>	Roh		
	<b>Klebeband</b>		
168632-42-00	Beigelegt	1	
<b>Aluminium</b>	Gebürstet		
<b>OUTDOOR</b>			
168632-42-18	Angebracht	1	

NEW

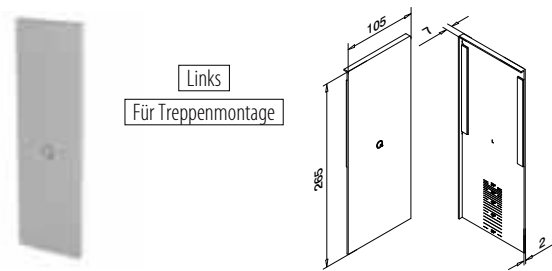

Links

Für Treppenmontage

**MOD 8633**

<b>Aluminium</b>	Gebürstet		
<b>OUTDOOR</b>	<b>Klebeband</b>		
168633-41-18	Angebracht	1	

NEW

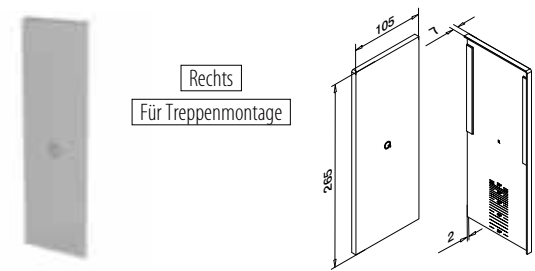

Rechts

Für Treppenmontage

**MOD 8633**

<b>Aluminium</b>	Gebürstet		
<b>OUTDOOR</b>	<b>Klebeband</b>		
168633-42-18	Angebracht	1	

NEW





Geländerbasis

Drainageleisten zur Seitenmontage

4 Stück für 2,5-Meter-Bodenprofil

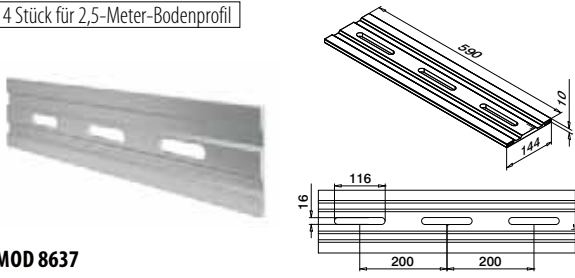

MOD 8637

Aluminium Gebürstet

OUTDOOR

168637-18



4

NEW

Geländerbasis

Unterlegscheiben zur Seitenmontage

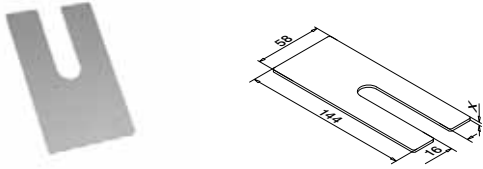

MOD 8636

Aluminium Roh

	X	
168636-001	1	100
168636-002	2	100
168636-003	3	100

NEW

Q-INFO MOD 8637

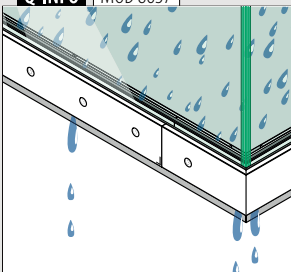

Montage-  
informationen:



<https://q-ne.ws/Strong23>

Q-INFO MOD 8636

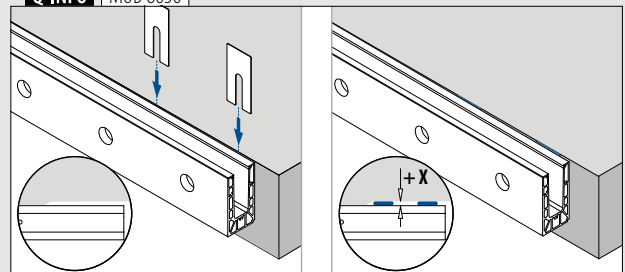

## Blendstopfen zur Seitenmontage

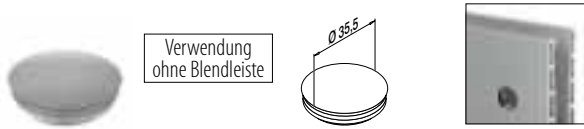

Verwendung  
ohne Blendleiste

### MOD 8238

<b>Kunststoff</b>	Aluminium RAL 9006
<b>INDOOR</b>	
158238-36	10

## Blendleisten zur Seitenmontage

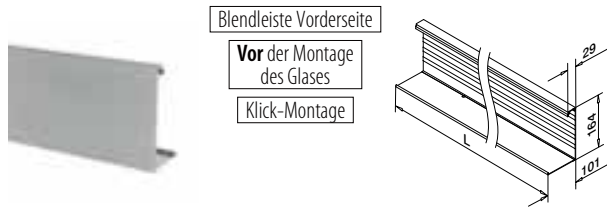

Blendleiste Vorderseite

Vor der Montage  
des Glases

Klick-Montage

### MOD 8634

<b>Aluminium</b>	Roh
	
168634-050-00	L = 5 m
<b>Aluminium</b>	Gebürstet
<b>OUTDOOR</b>	
168634-050-18	L = 5 m



#### Q-INFO MOD 8238

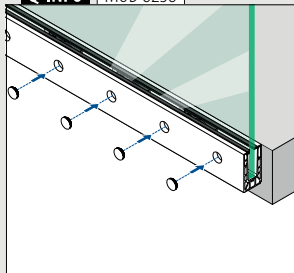

#### Q-INFO Aluminium

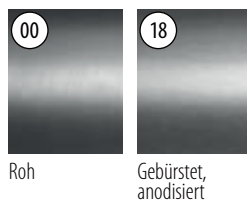

#### Q-INFO MOD 8634

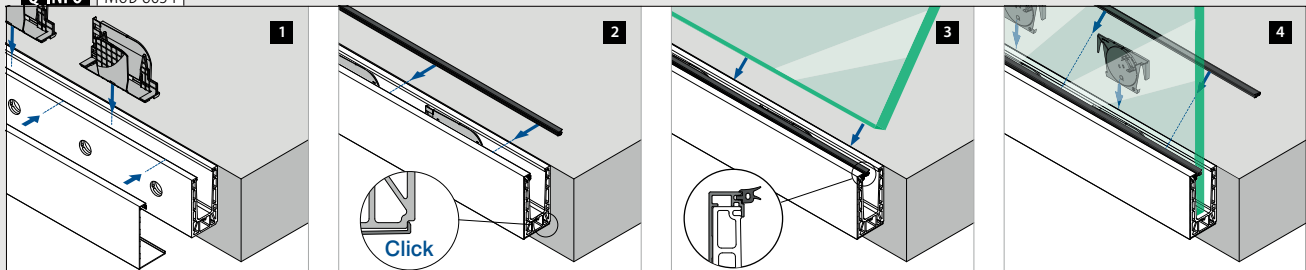

Geländerbasis

**Bauanschlussleisten**

Für alle Strong-Profile

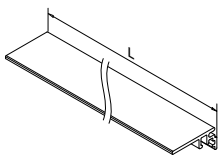
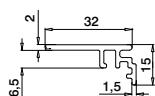

**MOD 6973**

<b>Aluminium</b>	Roh	
166973-50-00		L = 5 m
<b>Aluminium</b>	Gebürstet	
<b>OUTDOOR</b>		
166973-50-18		L = 5 m

**PREFIX**

Für Strong **Boden-**  
montage-Profile

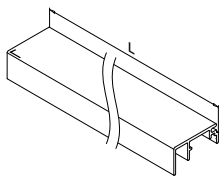
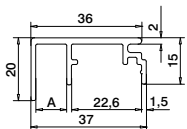

**MOD 6975**

<b>Aluminium</b>	Roh	
	<b>A</b>	
166975-010-50-00	10	L = 5 m
<b>Aluminium</b>	Gebürstet	
<b>OUTDOOR</b>		
166975-010-50-18	10	L = 5 m

**NEW**

**PREFIX**

Für alle Strong-Profile

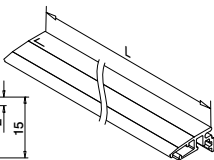
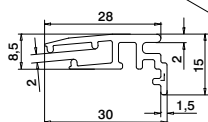

**MOD 6979**

<b>Aluminium</b>	Roh	
166979-002-50-00		L = 5 m
<b>Aluminium</b>	Gebürstet	
<b>OUTDOOR</b>		
166979-002-50-18		L = 5 m

**NEW**

**PREFIX**

Für Strong **Boden-**  
montage-Profile

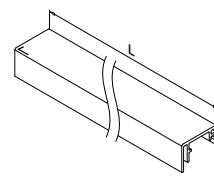
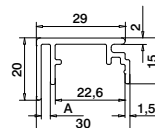

**MOD 6975**

<b>Aluminium</b>	Roh	
	<b>A</b>	
166975-003-50-00	3	L = 5 m
<b>Aluminium</b>	Gebürstet	
<b>OUTDOOR</b>		
166975-003-50-18	3	L = 5 m

**NEW**

**PREFIX**

Für Strong **Boden-**  
montage-Profile

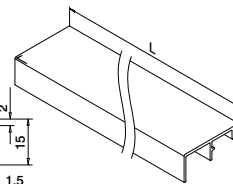
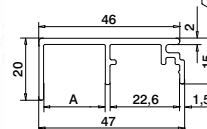

**MOD 6975**

<b>Aluminium</b>	Roh	
	<b>A</b>	
166975-020-50-00	20	L = 5 m
<b>Aluminium</b>	Gebürstet	
<b>OUTDOOR</b>		
166975-020-50-18	20	L = 5 m

**NEW**

**PREFIX**

Geländerbasis

**Bauanschlussleisten-/Trenngummi**

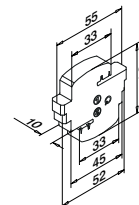

**MOD 8605**

<b>Zubehör</b>	
208605-010	5

**NEW**

**PREFIX**

**Q-INFO** Aluminium

00	18
Roh	Gebürstet, anodisiert

**Q-INFO**

**PREFIX**

**Q-INFO** MOD 8605

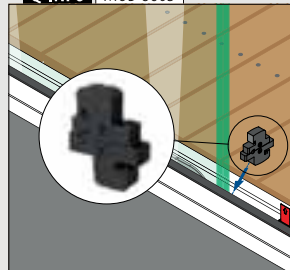

Bauanschlussleisten

Für alle Strong-Profile

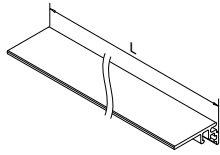
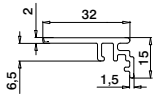

**MOD 6973**

<b>Aluminium</b>	Roh		
166973-50-00		L = 5 m	
<b>Aluminium</b>	Gebürstet		
<b>OUTDOOR</b>			
166973-50-18		L = 5 m	

**PREFIX**

Für Strong  
Seitenmontage-Profile

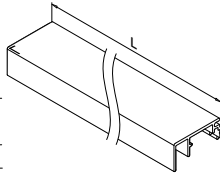
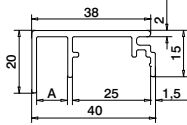

**MOD 6977**

<b>Aluminium</b>	Roh		
	<b>A</b>		
166977-010-50-00	10	L = 5 m	
<b>Aluminium</b>	Gebürstet		
<b>OUTDOOR</b>			
166977-010-50-18	10	L = 5 m	

**NEW**

**PREFIX**

Für Strong  
Seitenmontage-Profile

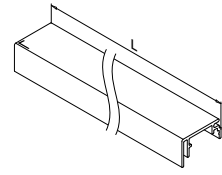
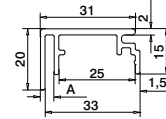

**MOD 6977**

<b>Aluminium</b>	Roh		
	<b>A</b>		
166977-003-50-00	3	L = 5 m	
<b>Aluminium</b>	Gebürstet		
<b>OUTDOOR</b>			
166977-003-50-18	3	L = 5 m	

**NEW**

**PREFIX**

Für Strong  
Seitenmontage-Profile

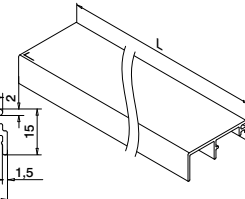
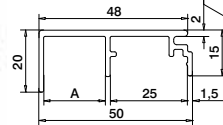

**MOD 6977**

<b>Aluminium</b>	Roh		
	<b>A</b>		
166977-020-50-00	20	L = 5 m	
<b>Aluminium</b>	Gebürstet		
<b>OUTDOOR</b>			
166977-020-50-18	20	L = 5 m	

**NEW**

**PREFIX**

**Q-INFO** MOD 6979

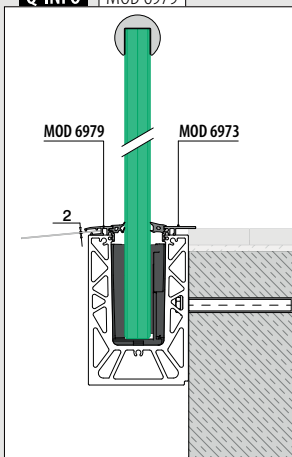

**Q-INFO** MOD 6975 / 6973

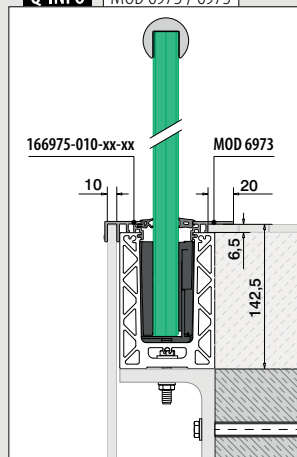

**Q-INFO** MOD 6977 / 6973

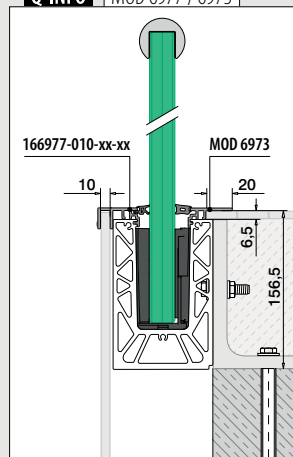





- Beanspruchung:** Leicht  
**Verwendung:** Innen- und Außenbereich  
**Montage:** Boden-, In-Boden- und Seitenmontage  
**Anwendung:** Balkone, Galerien, Wege, Abtrennungen und Treppen  
**Material:** Aluminium (roh oder gebürstet anodisiert)  
**Glasstärke:** 12 bis 21,52 mm

Finden Sie alle Informationen zu Easy Glass Slim online:



<https://q-ne.ws/Slim23>

# EASY GLASS<sup>®</sup> SLIM

# Hohe Transparenz, große Wirkung



Easy Glass® Slim ist der Klassiker in unserem Glasgeländer-Sortiment. Sein minimalistisches Design umfasst ein schmales Bodenprofil, das für einen eleganten Look sorgt und dazu beiträgt, das Gesamtgewicht des Geländers niedrig zu halten. Diese kosteneffiziente Geländerlösung ist daher perfekt für den Einsatz im privaten Bereich.

### Easy Glass® Slim

Max. Holmlast (kN/m)

DE

0,5

STATISCHE  
BERECH-  
NUNG  
DIN 18008

LGAP  
Typen  
geprüft

AbP  
BALIART  
GEPRÜFT

Bitte beachten Sie die Spezifikationen wie Befestigungs- und Glasmaße sowie Glastypen der jeweiligen Zertifikate.

### International getestet/berechnet/zertifiziert:



- 1 Das bodenmontierte Slim Bodenprofil ist nur 45 mm breit, was es zu einer kosteneffizienten Lösung macht und zeitgleich für ein schlicht-elegantes Erscheinungsbild sorgt.
- 2 Das Bodenprofil ist leicht und einfach zu handhaben und daher ideal für das Manövrieren auf der Baustelle.

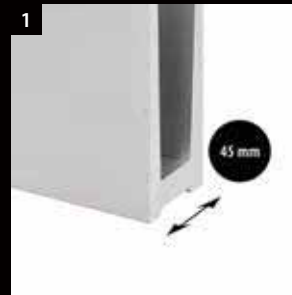

## EASY GLASS® SLIM MONTAGEOPTIONEN

### Slim

Bodenmontage

- Auch für die In-Bodenmontage geeignet

97

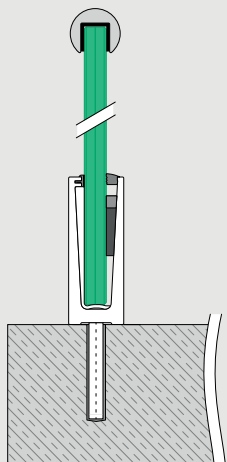

### Slim F

Bodenmontage

- Für Rohfußböden
- Kann direkt an der Bodenkante angebracht werden

99

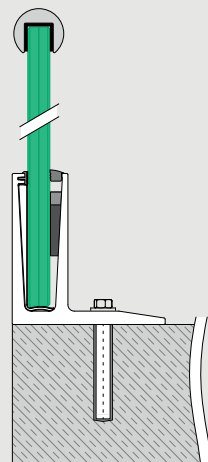

### Slim

Seitenmontage

- Optionale Bodenprofil-Blendeleiste

100

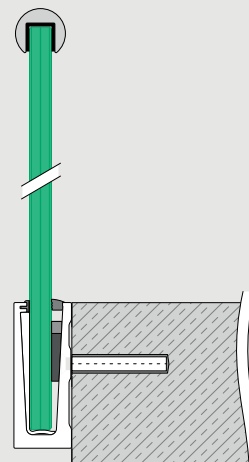

Geländerbasis

Safety Wedge System (Gummi- und Keilsets)

Glasklemmung (nicht justierbar)

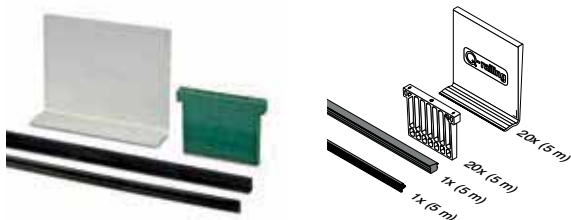

MOD 8000

Zubehör

Für monolithisches Glas	T	
208000-050-12	12	L = 5 m
208000-050-15	15	L = 5 m
208000-050-19	19	L = 5 m

Für laminiertes Glas

208000-050-13	12,76	L = 5 m
208000-050-14	13,52	L = 5 m
208000-050-17	16,76	L = 5 m
208000-050-18	17,52	L = 5 m
208000-050-21	20,76	L = 5 m
208000-050-22	21,52	L = 5 m

Zubehör

Easy Glass® Multitool



MOD 1001

Zubehör

	Q	
201001	Q-71	1

Geländerbasis

Trenngummi

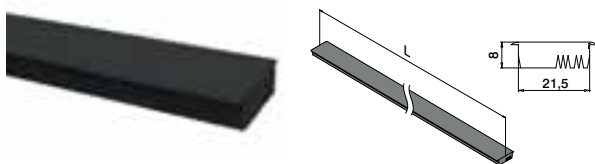

MOD 8105

Zubehör

	208105-025		L = 2,5 m
--	------------	--	-----------



Nur solange der Vorrat reicht.

Q-INFO MOD 8105

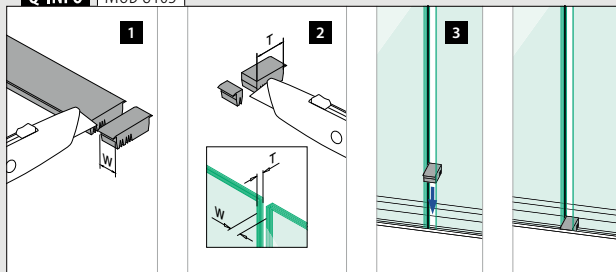

Q-INFO MOD 1001

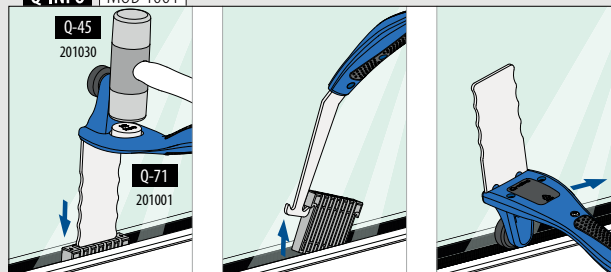

Bodenprofile zur Bodenmontage

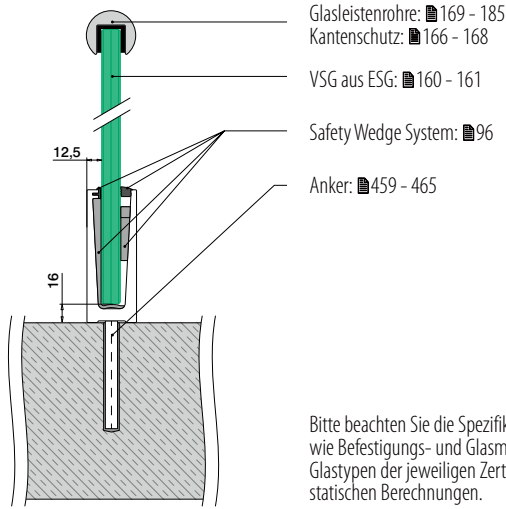

Bitte beachten Sie die Spezifikationen wie Befestigungs- und Glasmaße sowie Glastypen der jeweiligen Zertifikate und statischen Berechnungen.

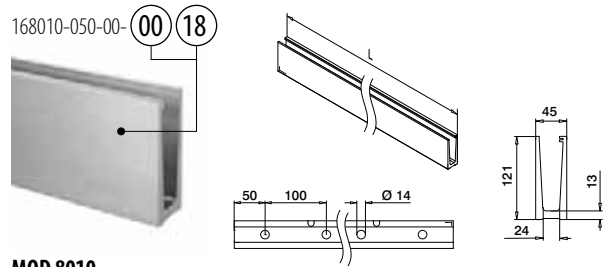

**MOD 8010**

Aluminium Roh

**NEW** 168010-050-00-00 ■ 459 - 465 L = 5 m

Aluminium Gebürstet

**OUTDOOR**

**SELL OUT** 168010-050-00-18 ■ 459 - 465 L = 5 m

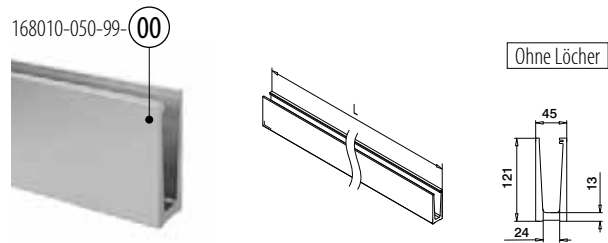

**MOD 8010**

Aluminium Roh

**SELL OUT** 168010-050-99-00 L = 5 m



Ecken zur Bodenmontage

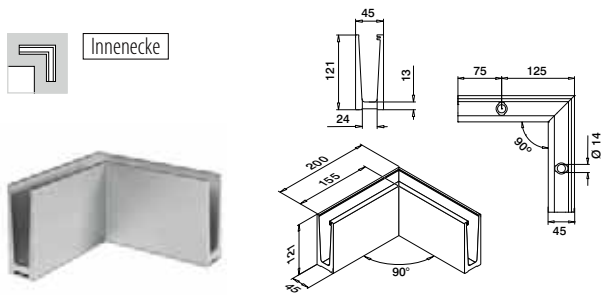

**MOD 8011**

Aluminium Gebürstet

**OUTDOOR**

**SELL OUT** 168011-01-18 ■ 459 - 465 1

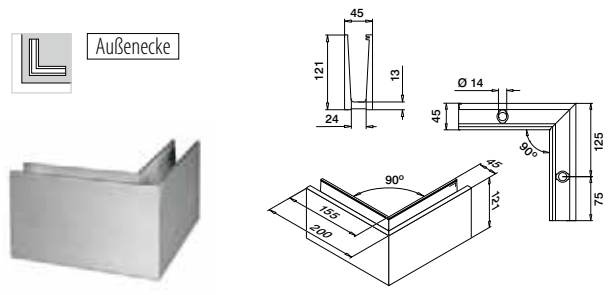

**MOD 8011**

Aluminium Gebürstet

**OUTDOOR**

**SELL OUT** 168011-02-18 ■ 459 - 465 1



**Q-INFO** MOD 8010

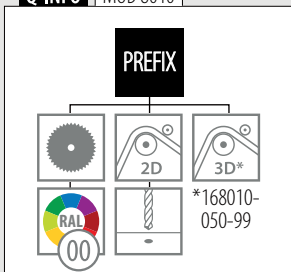

**Q-INFO**

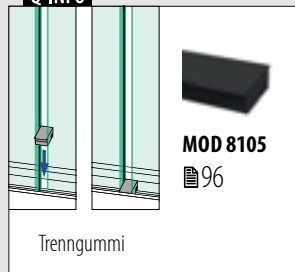

**Q-INFO** Aluminium





Geländerbasis

Endkappen zur Bodenmontage

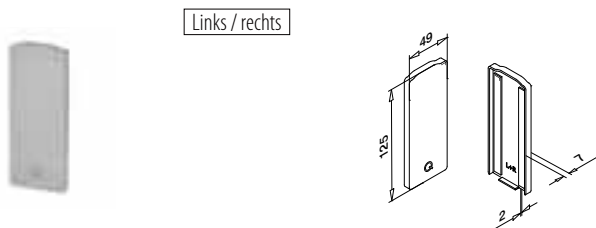

Links / rechts

**MOD 8012**

Aluminium Roh

**Klebeband**



SELL OUT	168012-00-00	Beigelegt	1
----------	--------------	-----------	---

Aluminium Gebürstet

**OUTDOOR**

SELL OUT	168012-00-18	Angebracht	1
----------	--------------	------------	---

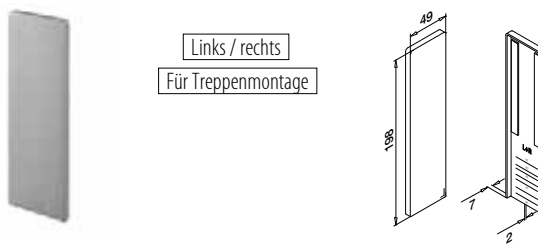

Links / rechts  
Für Treppenmontage

**MOD 8013**

Aluminium Gebürstet

**OUTDOOR**

**Klebeband**



SELL OUT	168013-00-18	Angebracht	1
----------	--------------	------------	---



Geländerbasis

Drainageleisten zur Bodenmontage

Reicht für 2,5 m Bodenprofil

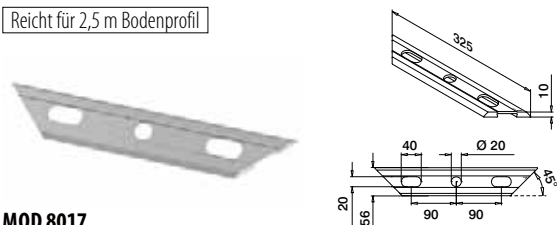

**MOD 8017**

Aluminium Gebürstet

**OUTDOOR**



SELL OUT	168017-18		8
----------	-----------	--	---

Internationaler Geschmacksmusterschutz

Q-INFO MOD 8017

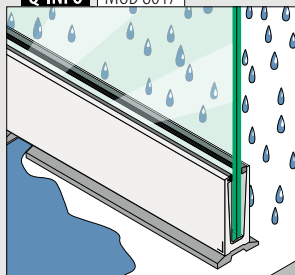

Montage-  
informationen:



<https://q-ne.ws/Slim23>

Q-INFO Aluminium

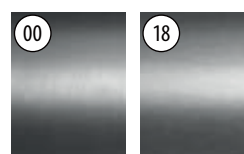

Roh

Gebürstet,  
anodisiert

Q-INFO MOD 8012

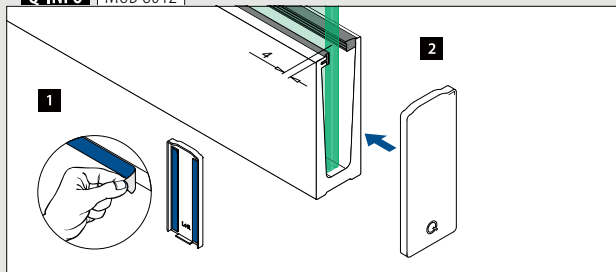

Q-INFO MOD 8013

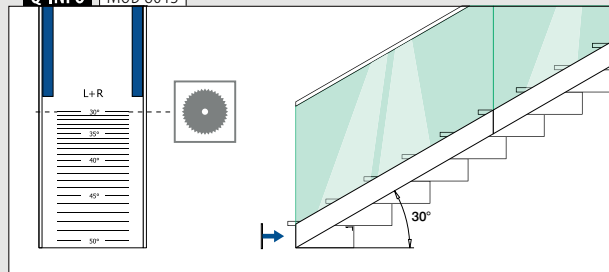

Bodenprofile zur Bodenmontage

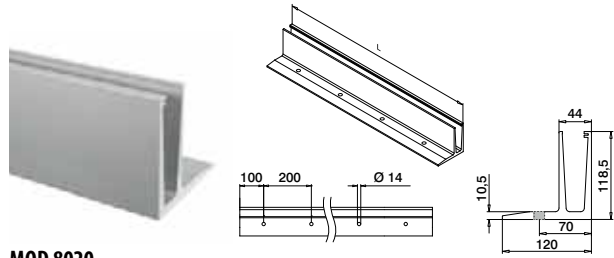
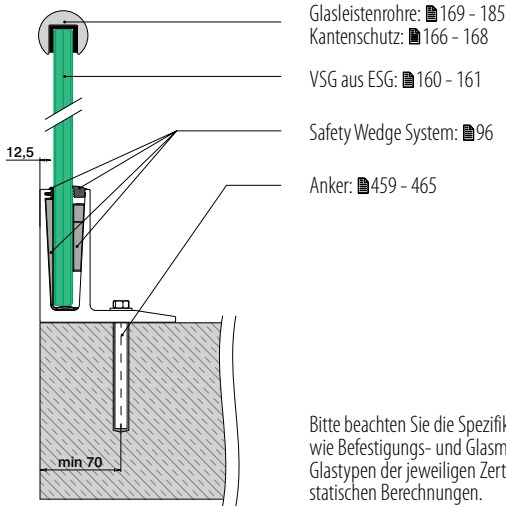

MOD 8020

Aluminium Gebürstet

OUTDOOR

SELL OUT 168020-050-00-18 ■ 459 - 465 L = 5 m



Ecken zur Bodenmontage

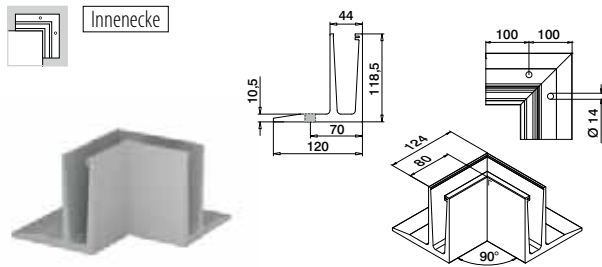

MOD 8021

Aluminium Gebürstet

OUTDOOR

SELL OUT 168021-01-18 ■ 459 - 465 1

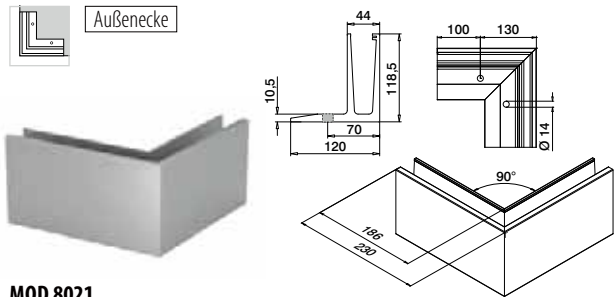

MOD 8021

Aluminium Gebürstet

OUTDOOR

SELL OUT 168021-02-18 ■ 459 - 465 1



Endkappen zur Bodenmontage

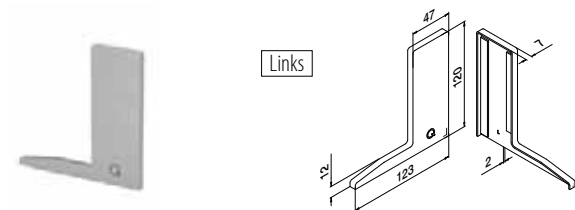

MOD 8022

Aluminium Gebürstet

OUTDOOR

Kleband

SELL OUT 168022-01-18 Angebracht 1

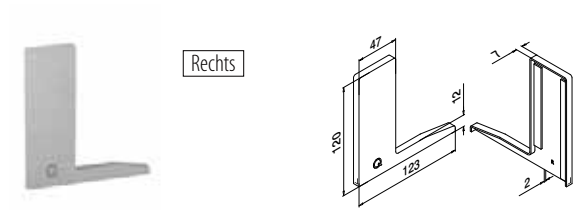

MOD 8022

Aluminium Gebürstet

OUTDOOR

Kleband

SELL OUT 168022-02-18 Angebracht 1

Q-INFO MOD 8020

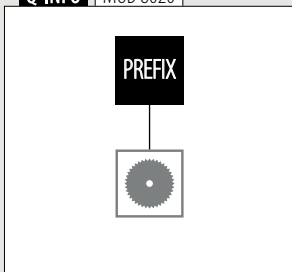

Q-INFO

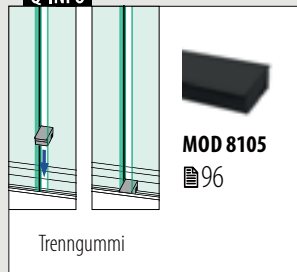

Q-INFO MOD 8022

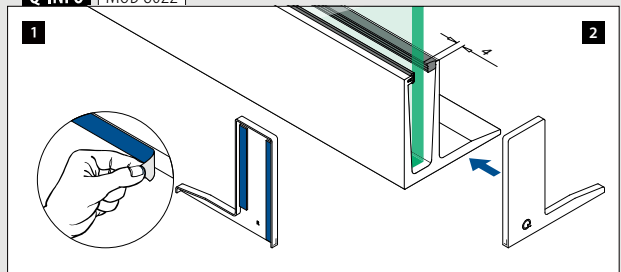

Geländerbasis

Bodenprofile zur Seitenmontage

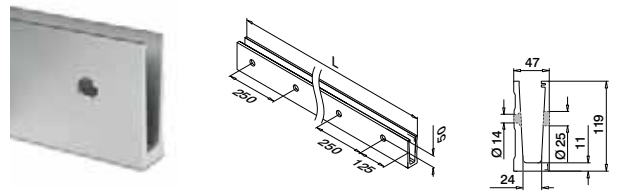
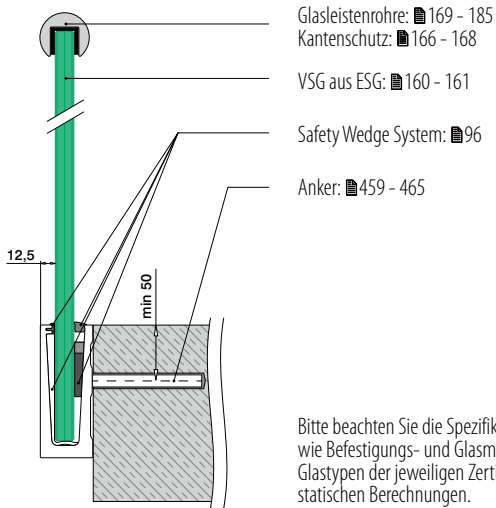

**MOD 8030**

**Aluminium** Gebürstet

**OUTDOOR**

SELL OUT 168030-050-00-18 ■ 459 - 465 L = 5 m



Geländerbasis

Ecken zur Seitenmontage

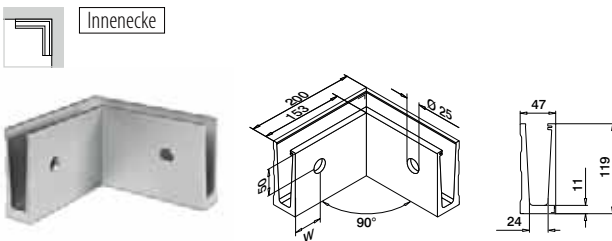

**MOD 8031**

**Aluminium** Gebürstet

**OUTDOOR**

**W**

■ 459 - 465 1

SELL OUT 168031-01-18 100\*

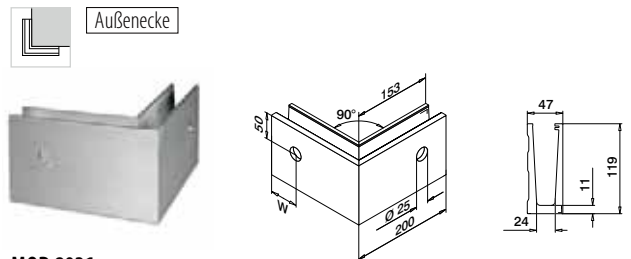

**MOD 8031**

**Aluminium** Gebürstet

**OUTDOOR**

**W**

■ 459 - 465 1

SELL OUT 168031-02-18 100\*



\*Die Lochposition kann produktionsbedingt abweichen.

**Q-INFO** MOD 8030

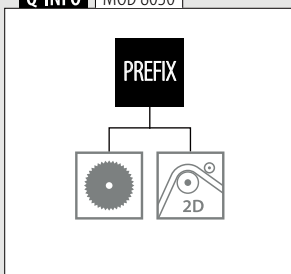

**Q-INFO**

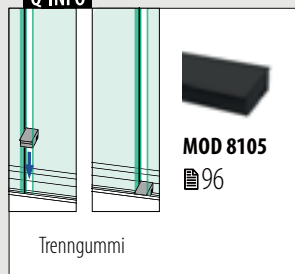

SELL OUT Nur solange der Vorrat reicht.

Endkappen zur Seitenmontage



Links  
Verwendung bei Blendleiste

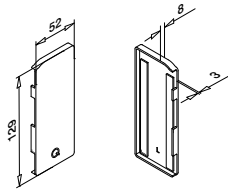

MOD 8034

Aluminium Gebürstet

OUTDOOR

Klebeband



SELL OUT	168034-01-18	Angebracht	1
----------	--------------	------------	---



Rechts  
Verwendung bei Blendleiste

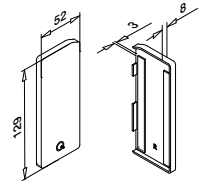

MOD 8034

Aluminium Gebürstet

OUTDOOR

Klebeband



SELL OUT	168034-02-18	Angebracht	1
----------	--------------	------------	---



Links  
Verwendung ohne Blendleiste

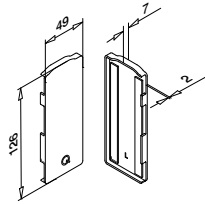

MOD 8032

Aluminium Gebürstet

OUTDOOR

Klebeband



SELL OUT	168032-01-18	Angebracht	1
----------	--------------	------------	---



Rechts  
Verwendung ohne Blendleiste

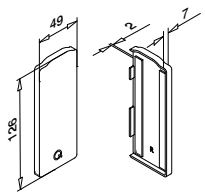

MOD 8032

Aluminium Gebürstet

OUTDOOR

Klebeband



SELL OUT	168032-02-18	Angebracht	1
----------	--------------	------------	---



Links  
Verwendung mit  
oder ohne Blendleiste  
Für Treppenmontage

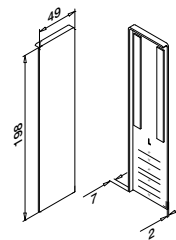

MOD 8033

Aluminium Gebürstet

OUTDOOR

Klebeband



SELL OUT	168033-01-18	Angebracht	1
----------	--------------	------------	---



Rechts  
Verwendung mit  
oder ohne Blendleiste  
Für Treppenmontage

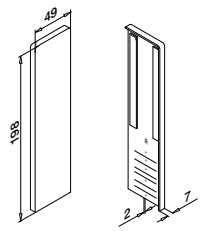

MOD 8033

Aluminium Gebürstet

OUTDOOR

Klebeband



SELL OUT	168033-02-18	Angebracht	1
----------	--------------	------------	---



Q-INFO MOD 8032 / 8034

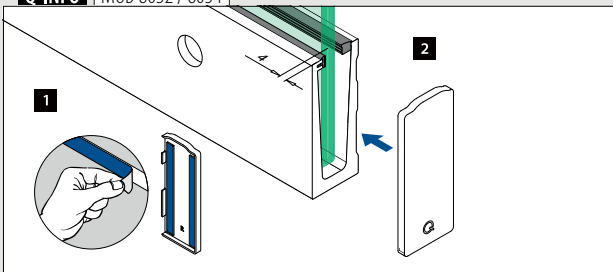

Q-INFO MOD 8033

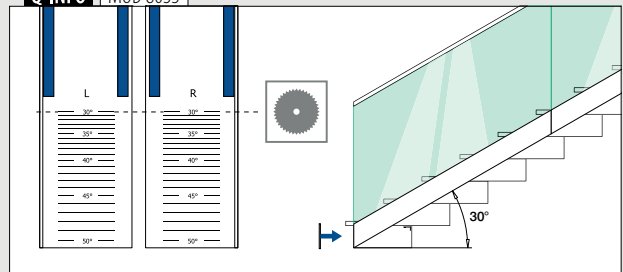



Geländerbasis

Blendleisten zur Seitenmontage



MOD 8035

Aluminium Gebürstet

OUTDOOR

Klebband



L = 2,5 m

SELL OUT

168035-025-18

Angebracht

Geländerbasis

Blendstopfen zur Seitenmontage

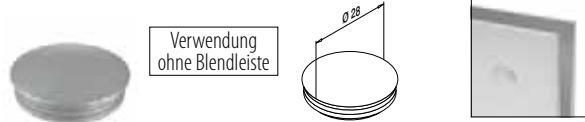

Verwendung ohne Blendleiste

MOD 8038

Kunststoff Aluminium RAL 9006

INDOOR



SELL OUT

158038-36

10

SELL OUT Nur solange der Vorrat reicht.

Q-INFO MOD 8035

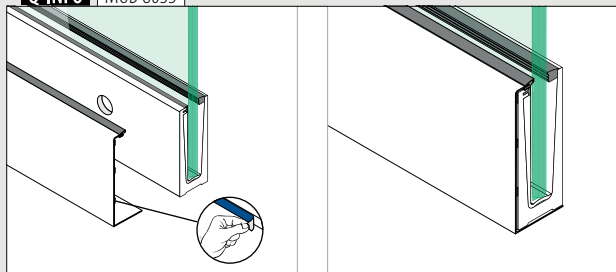

Q-INFO MOD 8038

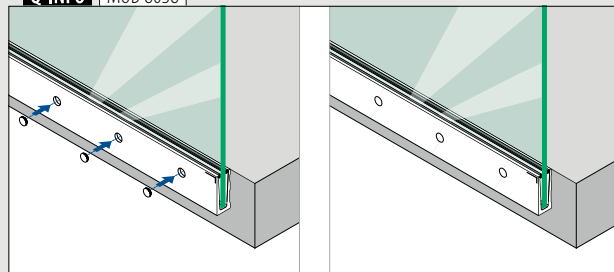







- Beanspruchung:** Leicht bis hoch  
**Verwendung:** Innen- und Außenbereich  
**Montage:** Boden-, In-Boden- und Seitenmontage  
**Anwendung:** Balkone, Galerien, Wege, Abtrennungen und Treppen  
**Material:** Aluminium (roh oder gebürstet anodisiert)  
**Glasstärke:** 12 bis 21,52 mm

Finden Sie alle Informationen zu Easy Glass Pro online:

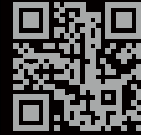

<https://q-ne.ws/Pro23>

# EASY GLASS® PRO

# Erledigen Sie alle notwendigen Arbeiten von der Innenseite des Geländers



Die Installation des Easy Glass® Pro Bodenprofils ist äußerst bequem. Auch die Justierung der Glasscheiben ist dank des einzigartigen Safety Wedge System mit Gummis und ausrichtbaren Keilen sehr einfach. Damit lässt sich die Glasfüllung bis zu 10 mm in der Vertikalen verstellen. Und mit vier verschiedenen Bodenprofilvarianten können Sie sicher sein, immer eine professionelle Lösung zu finden, die zu Ihrer spezifischen Montagesituation passt.

<b>Easy Glass® Pro</b>	<b>DE</b>
Max. Holmlast (kN/m)	1,0



Bitte beachten Sie die Spezifikationen wie Befestigungs- und Glasmaße sowie Glastypen der jeweiligen Zertifikate.

### International getestet/berechnet/zertifiziert:



- 1 Wählen Sie aus vier verschiedenen Bodenprofilen, um allen Projektanforderungen gerecht zu werden. Pro meistert selbst anspruchsvollste Bausituationen.
- 2 Richten Sie das Glas um bis zu 10 mm (1°) in der Vertikalen aus – und das von der Innenseite des Geländers.

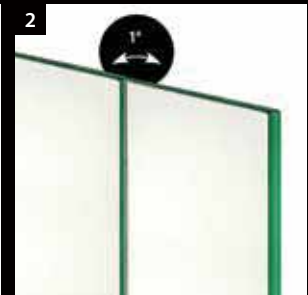

## EASY GLASS® PRO MONTAGEOPTIONEN

### Pro Bodenmontage

- Auch für die In-Bodenmontage geeignet

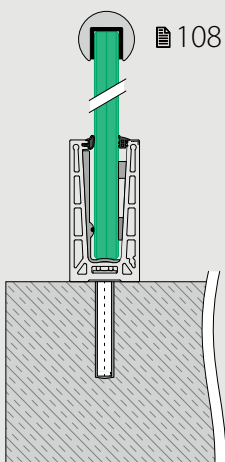

### Pro F Bodenmontage

- Für Rohfußböden
- Kann direkt an oder über der Bodenkante angebracht werden

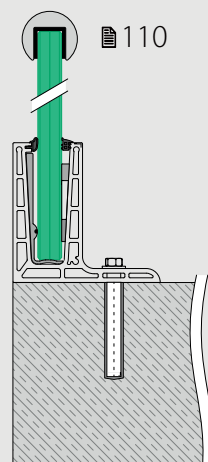

### Pro Seitenmontage

- Optionale Bodenprofil-Blendleiste
- Kann direkt an oder über der Bodenkante angebracht werden

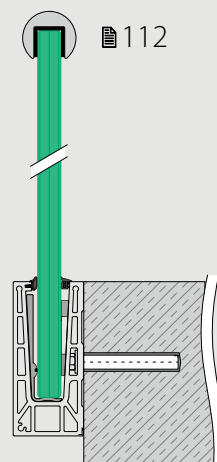

### Pro Y Seitenmontage

- Für Rohfußböden
- Kann direkt an oder über der Bodenkante angebracht werden
- Optionale Bodenprofil-Blendleiste

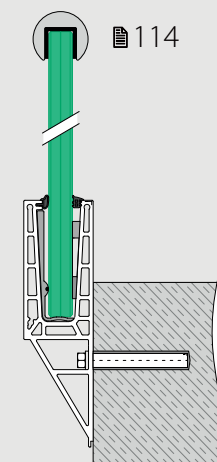



Geländerbasis

Safety Wedge System (Gummi- und Keilsets)

Glasklemmung und -justierung

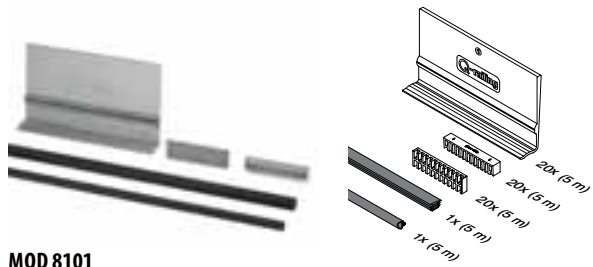

MOD 8101

Zubehör

Für monolithisches Glas		T	
SELL OUT	208101-050-12	12	L = 5 m
SELL OUT	208101-050-15	15	L = 5 m
SELL OUT	208101-050-19	19	L = 5 m

Für laminiertes Glas

SELL OUT	208101-050-13	12,76	L = 5 m
SELL OUT	208101-050-14	13,52	L = 5 m
SELL OUT	208101-050-17	16,76	L = 5 m
SELL OUT	208101-050-18	17,52	L = 5 m
SELL OUT	208101-050-21	20,76	L = 5 m
SELL OUT	208101-050-22	21,52	L = 5 m

Internationaler Geschmacksmusterschutz

Zubehör

Easy Glass® Multitool



MOD 1001

Zubehör

		Q	
201001		Q-71	1

Q-INFO | MOD 8101

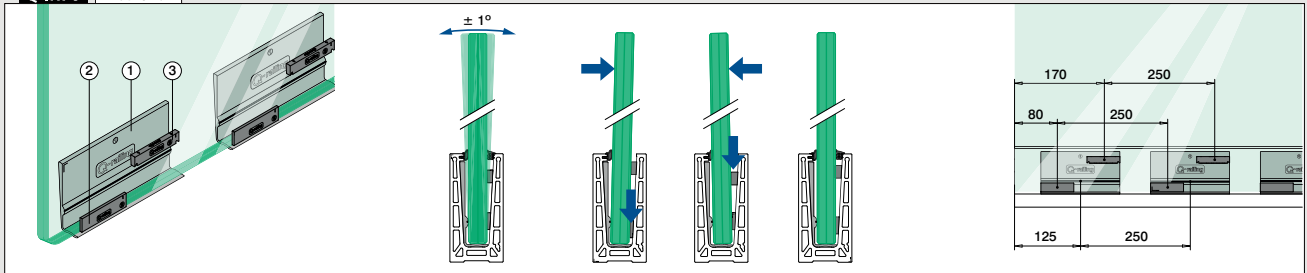

Geländerbasis

Safety Wedge System (Gummi- und Keilsets)

Glasklemmung (nicht justierbar)

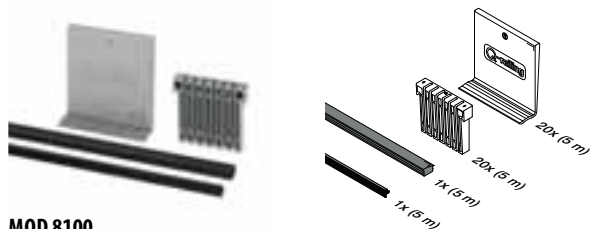

MOD 8100

Zubehör

Für monolithisches Glas		T	
SELL OUT	208100-050-12	12	L = 5 m
SELL OUT	208100-050-15	15	L = 5 m
SELL OUT	208100-050-19	19	L = 5 m

Für laminiertes Glas

SELL OUT	208100-050-13	12,76	L = 5 m
SELL OUT	208100-050-14	13,52	L = 5 m
SELL OUT	208100-050-17	16,76	L = 5 m
SELL OUT	208100-050-18	17,52	L = 5 m
SELL OUT	208100-050-21	20,76	L = 5 m
SELL OUT	208100-050-22	21,52	L = 5 m

Internationaler Geschmacksmusterschutz

Zubehör

Easy Glass® Multitool



MOD 1001

Zubehör

		Q	
201001		Q-71	1

Q-INFO | MOD 8100

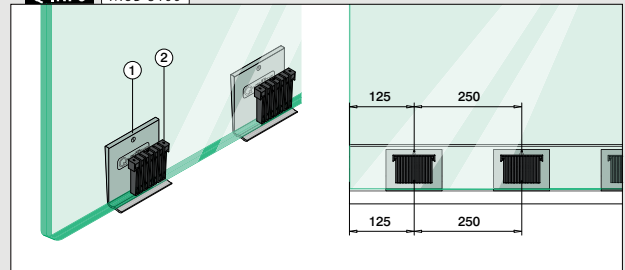

Safety Wedge System (Gummi- und Keilsets)

Glasklemmung und -justierung Easy Glass® Pro F

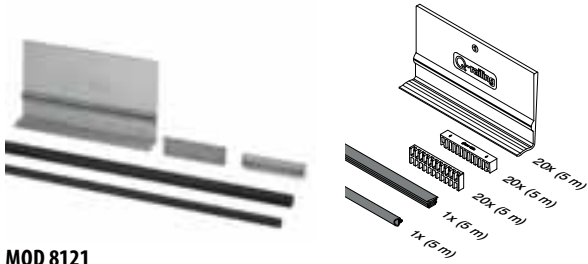

MOD 8121

Zubehör

Für monolithisches Glas		
	T	
208121-050-12	12	L = 5 m
208121-050-15	15	L = 5 m
208121-050-19	19	L = 5 m

Für laminiertes Glas

SELL OUT	208121-050-13	12,76	L = 5 m
SELL OUT	208121-050-14	13,52	L = 5 m
SELL OUT	208121-050-17	16,76	L = 5 m
SELL OUT	208121-050-18	17,52	L = 5 m
SELL OUT	208121-050-21	20,76	L = 5 m
SELL OUT	208121-050-22	21,52	L = 5 m

Internationaler Geschmacksmusterschutz

Easy Glass® Multitool



MOD 1001

Zubehör

	Q	
201001	Q-71	1

Q-INFO MOD 8121

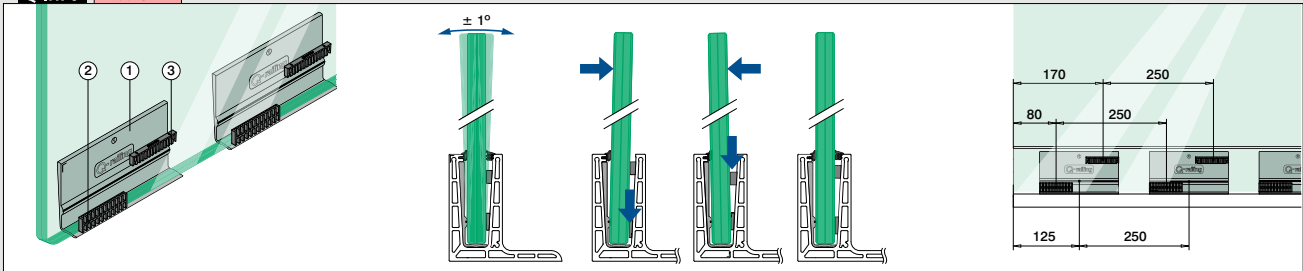

Verbindungsstifte

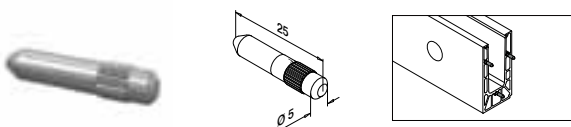

MOD 3005

V4A	316	Roh
<b>OUTDOOR</b>		
143005		6



SELL OUT Nur solange der Vorrat reicht.

Trenngummi

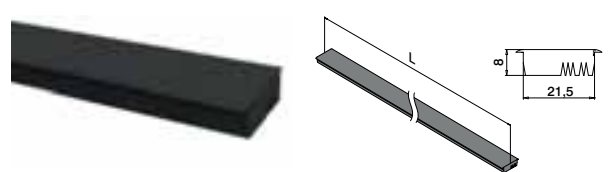

MOD 8105

Zubehör

SELL OUT	208105-025	L = 2,5 m
----------	------------	-----------



Q-INFO MOD 1001

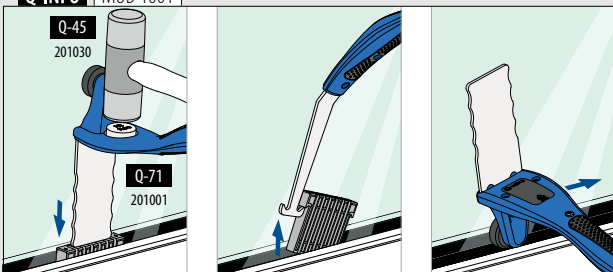

Q-INFO MOD 8105

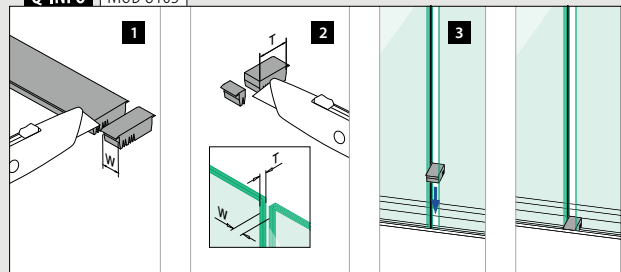

**Bodenprofile zur Bodenmontage**

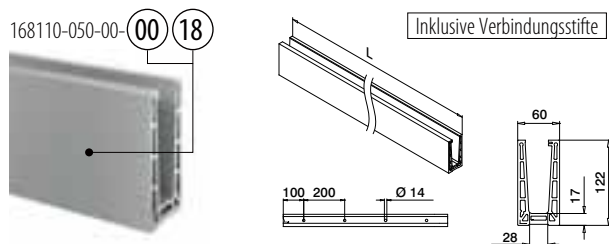
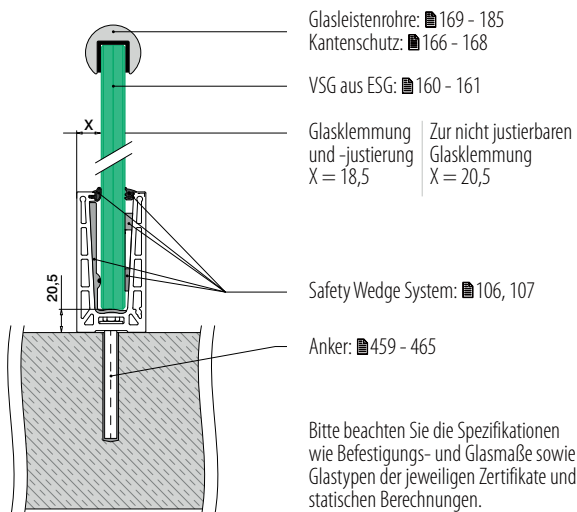

**MOD 8110**

**Aluminium** Roh

SELL OUT 168110-050-00-00 ■ 459 - 465 L = 5 m

**Aluminium** Gebürstet

**OUTDOOR**

SELL OUT 168110-050-00-18 ■ 459 - 465 L = 5 m



Internationaler Geschmacksmusterschutz

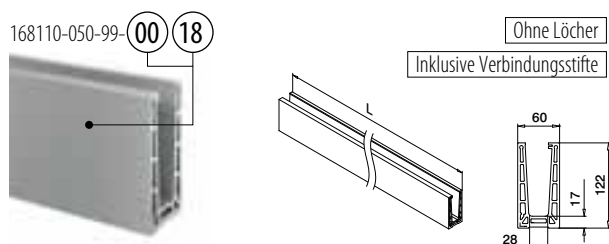

**MOD 8110**

**Aluminium** Roh

SELL OUT 168110-050-99-00 L = 5 m

**Aluminium** Gebürstet

**OUTDOOR**

SELL OUT 168110-050-99-18 L = 5 m



Internationaler Geschmacksmusterschutz

SELL OUT Nur solange der Vorrat reicht.

**Q-INFO**

PREFIX

**Q-INFO**

**MOD 8105**  
■ 107

Trenngummi

**Q-INFO Aluminium**

00 18

Roh Gebürstet, anodisiert

**Q-INFO**

**MOD 3005**  
■ 107

Zusätzliche Verbindungsstifte

Ecken zur Bodenmontage

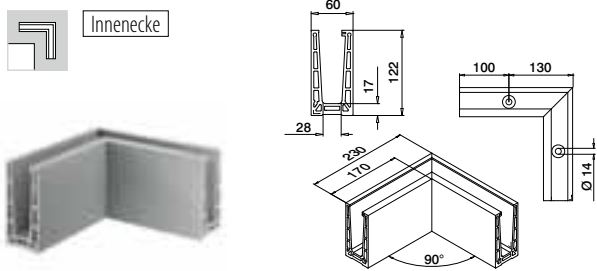

MOD 8111

Aluminium Gebürstet

OUTDOOR

SELL OUT	168111-01-18	459 - 465	1
----------	--------------	-----------	---

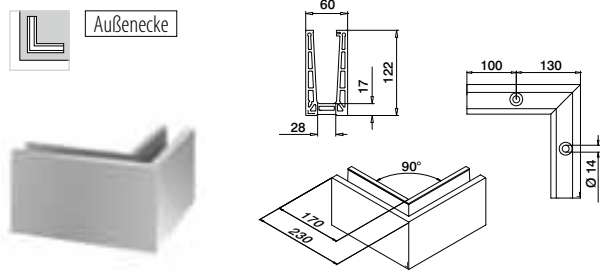

MOD 8111

Aluminium Gebürstet

OUTDOOR

SELL OUT	168111-02-18	459 - 465	1
----------	--------------	-----------	---



Endkappen zur Bodenmontage

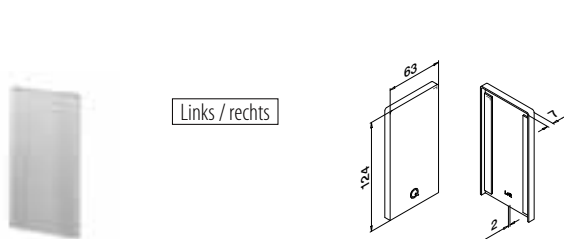

MOD 8112

Aluminium Roh

Klebeband

SELL OUT	168112-00-00	Beigelegt	1
----------	--------------	-----------	---

Aluminium Gebürstet

OUTDOOR

SELL OUT	168112-00-18	Angebracht	1
----------	--------------	------------	---

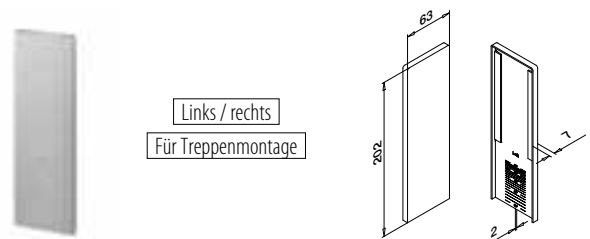

MOD 8113

Aluminium Gebürstet

OUTDOOR

Klebeband

SELL OUT	168113-00-18	Angebracht	1
----------	--------------	------------	---



Drainageleisten zur Bodenmontage

8 Stück für 5-Meter-Bodenprofil

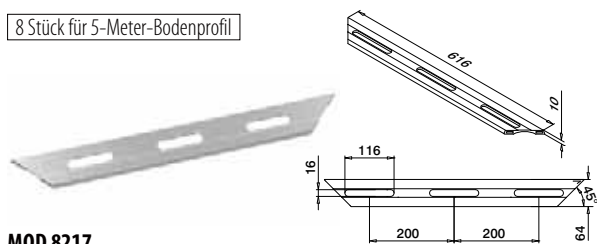

MOD 8217

Aluminium Gebürstet

OUTDOOR

168217-18	4
-----------	---

**Q-INFO** MOD 8217

Montageinformationen:

<https://q-ne.ws/Pro23>

**Q-INFO** MOD 8112

**Q-INFO** MOD 8113









Geländerbasis

Bodenprofile zur Seitenmontage

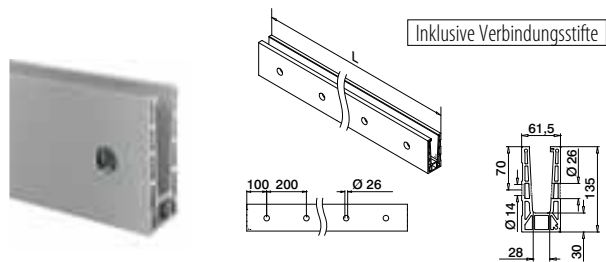
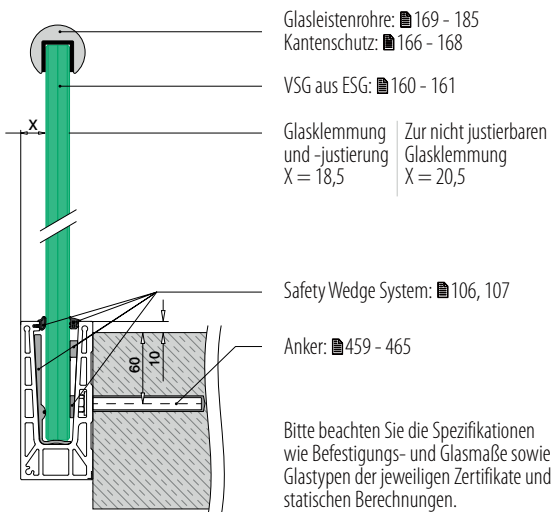

MOD 8130

Aluminium Gebürstet

OUTDOOR

SELL OUT 168130-050-00-18 ■ 459 - 465 L = 5 m



Internationaler Geschmacksmusterschutz

Geländerbasis

Ecken zur Seitenmontage

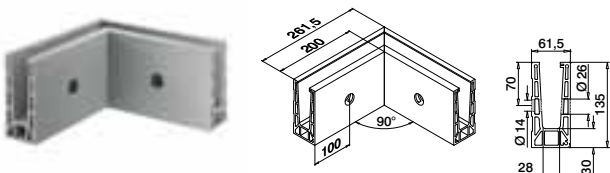
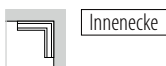

MOD 8131

Aluminium Gebürstet

OUTDOOR

SELL OUT 168131-01-18 ■ 459 - 465 1

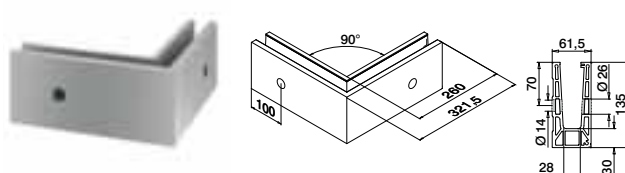

MOD 8131

Aluminium Gebürstet

OUTDOOR

SELL OUT 168131-02-18 ■ 459 - 465 1

Geländerbasis

Drainageleisten zur Seitenmontage

8 Stück für 5-Meter-Bodenprofil

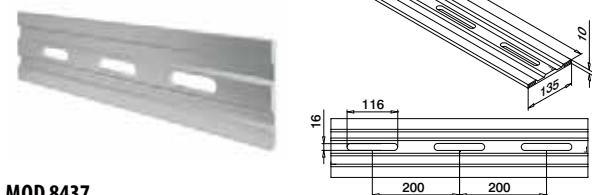

MOD 8437

Aluminium Gebürstet

OUTDOOR

SELL OUT 168437-18 4

Q-INFO MOD 8130 / 8131

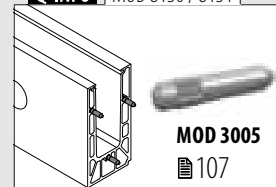

Zusätzliche Verbindungsstifte

Q-INFO MOD 8130

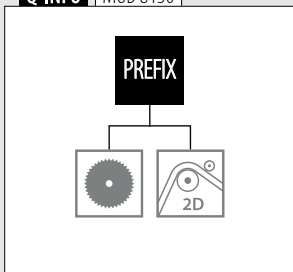

Q-INFO MOD 8130

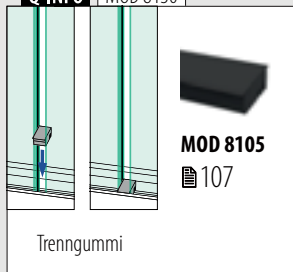

Q-INFO MOD 8437

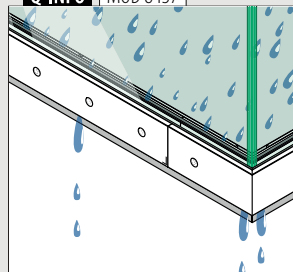

Montage-  
informationen:



<https://q-ne.ws/Pro23>

Endkappen zur Seitenmontage

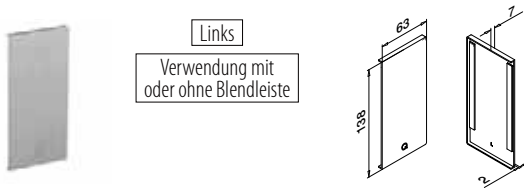

**MOD 8132**

**Aluminium** Gebürstet

**OUTDOOR**

**Klebeband**



SELL OUT 168132-01-18

Angebracht

1

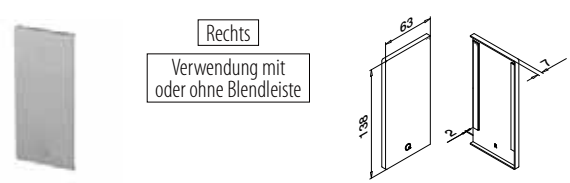

**MOD 8132**

**Aluminium** Gebürstet

**OUTDOOR**

**Klebeband**



SELL OUT 168132-02-18

Angebracht

1

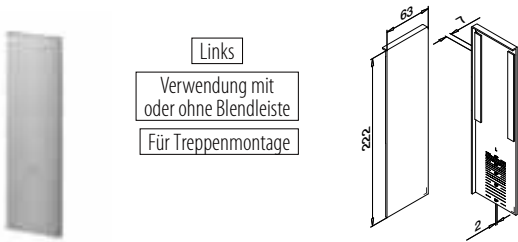

**MOD 8133**

**Aluminium** Gebürstet

**OUTDOOR**

**Klebeband**



SELL OUT 168133-01-18

Angebracht

1

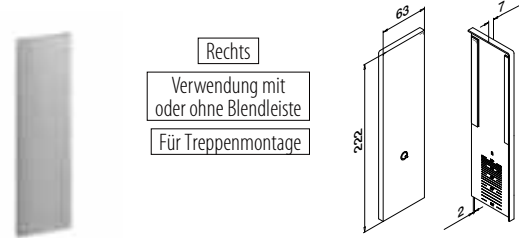

**MOD 8133**

**Aluminium** Gebürstet

**OUTDOOR**

**Klebeband**



SELL OUT 168133-02-18

Angebracht

1



Blendleisten zur Seitenmontage



**MOD 8135**

**Aluminium** Gebürstet

**OUTDOOR**

**Klebeband**



SELL OUT 168135-050-18

Angebracht

L = 5 m



Blendstopfen zur Seitenmontage

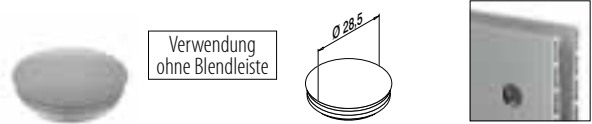

**MOD 8138**

**Kunststoff** Aluminium RAL 9006

**INDOOR**



SELL OUT 158138-36

10

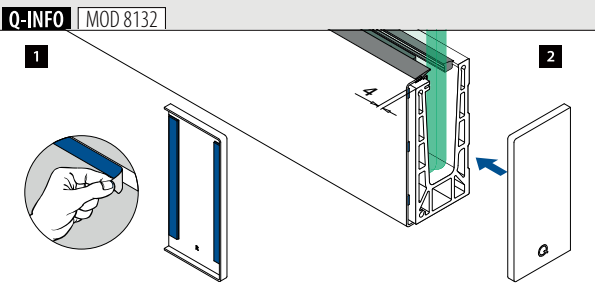
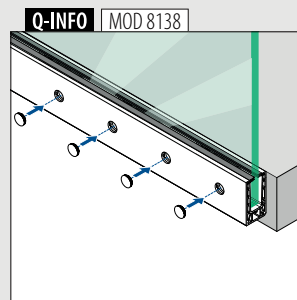
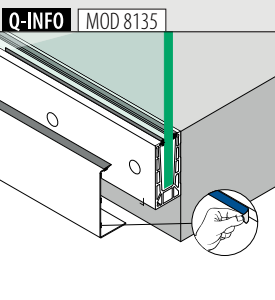

SELL OUT Nur solange der Vorrat reicht.

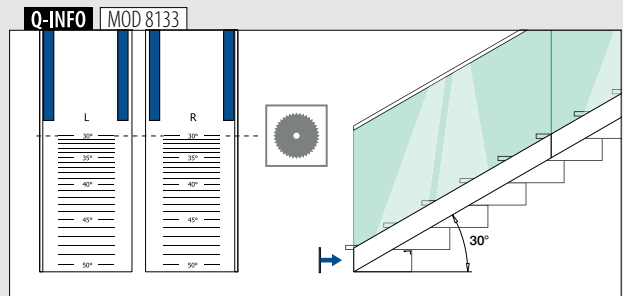



Bodenprofile zur Seitenmontage

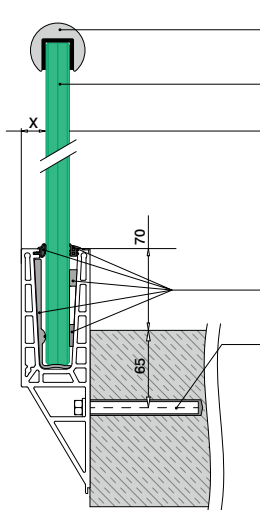

- Glasleistenrohre: ■ 169 - 185
- Kantenschutz: ■ 166 - 168
- VSG aus ESG: ■ 160 - 161
- Glasklebung und -justierung X = 18,5
- Zur nicht justierbaren Glasklebung X = 20,5
- Safety Wedge System: ■ 106, 107
- Anker: ■ 459 - 465

Bitte beachten Sie die Spezifikationen wie Befestigungs- und Glasmaße sowie Glastypeen der jeweiligen Zertifikate und statischen Berechnungen.

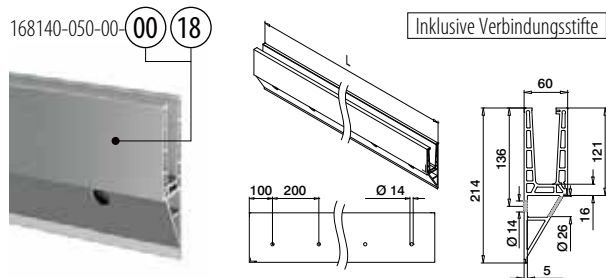

**MOD 8140**

**Aluminium** Roh

SELL OUT	168140-050-00-00	■ 459 - 465	L = 5 m
----------	------------------	-------------	---------

**Aluminium** Gebürstet

SELL OUT	168140-050-00-18	■ 459 - 465	L = 5 m
----------	------------------	-------------	---------



Internationaler Geschmacksmusterschutz

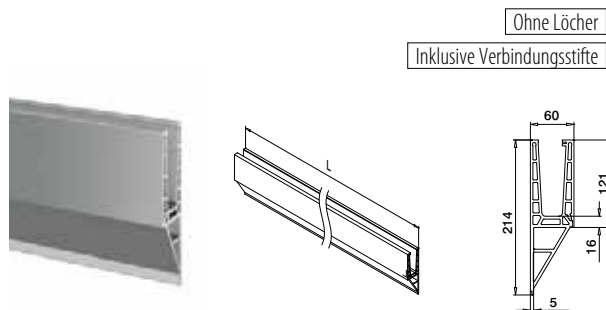

**MOD 8140**

**Aluminium** Gebürstet

**OUTDOOR**

SELL OUT	168140-050-99-18	L = 5 m
----------	------------------	---------



Internationaler Geschmacksmusterschutz

**SELL OUT** Nur solange der Vorrat reicht.

**Q-INFO**

**PREFIX**

**Q-INFO**

**MOD 8105**  
■ 107

Trenngummi

**Q-INFO** **Aluminium**

00

Roh

18

Gebürstet, anodisiert

**Q-INFO**

**MOD 3005**  
■ 107

Zusätzliche Verbindungsstifte

Ecken zur Seitenmontage

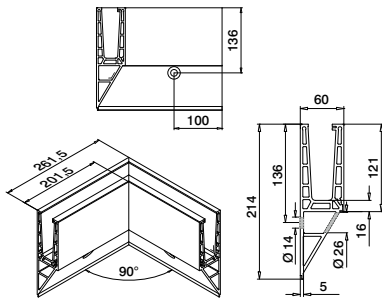
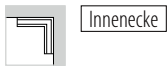

MOD 8141

Aluminium Gebürstet  
OUTDOOR

SELL OUT	168141-01-18	459 - 465	1
----------	--------------	-----------	---

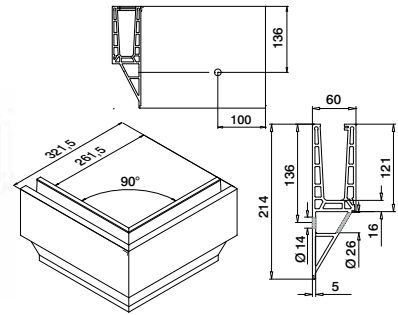

MOD 8141

Aluminium Gebürstet  
OUTDOOR

SELL OUT	168141-02-18	459 - 465	1
----------	--------------	-----------	---



Endkappen zur Seitenmontage



Links

Verwendung mit  
oder ohne Blendleiste

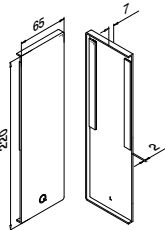

MOD 8142

Aluminium Gebürstet  
OUTDOOR

Klebeband

SELL OUT	168142-01-18	Angebracht	1
----------	--------------	------------	---



Rechts

Verwendung mit  
oder ohne Blendleiste

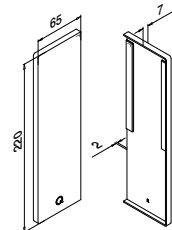

MOD 8142

Aluminium Gebürstet  
OUTDOOR

Klebeband

SELL OUT	168142-02-18	Angebracht	1
----------	--------------	------------	---

Blendleisten zur Seitenmontage



Blendleiste Vorderseite

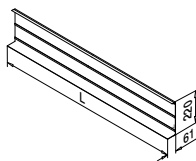

MOD 8145

Aluminium Gebürstet  
OUTDOOR

Klebeband

SELL OUT	168145-050-18	Angebracht	L = 5 m
----------	---------------	------------	---------



Q-INFO MOD 8142

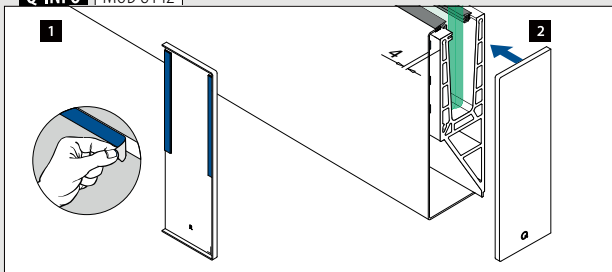

Q-INFO MOD 8145

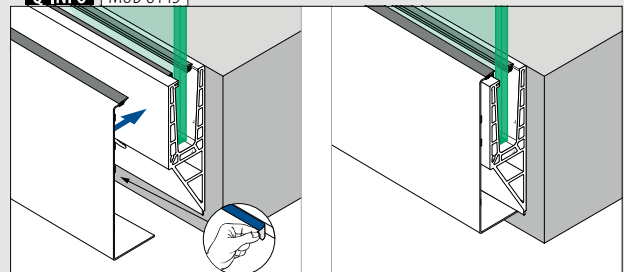



**Beanspruchung:** Hoch und besonders hoch  
**Verwendung:** Innen- und Außenbereich  
**Montage:** Boden-, In-Boden- und Seitenmontage  
**Anwendung:** Balkone, Galerien, Wege, Abtrennungen und Treppen  
**Material:** Aluminium (gebürstet anodisiert und roh)  
**Glasstärke:** 19 bis 31,52 mm

Finden Sie alle Informationen zu Easy Glass Max online:



<https://q-ne.ws/Max23>

# EASY GLASS<sup>®</sup> MAX



# Außerordentlich robust und sicher



Das elegante Kraftpaket hält extremen Belastungen und hohen Windlasten stand. Seine ausgezeichnete Kombination von Eigenschaften macht Max zur perfekten Wahl für öffentliche Einrichtungen mit hohen Sicherheitsanforderungen, darunter Stadien, Flughäfen und Einkaufszentren.

<b>Easy Glass® Max</b>	<b>DE</b>
Max. Holmlast (kN/m)	3,0



Bitte beachten Sie die Spezifikationen wie Befestigungs- und Glasmaße sowie Glastypen der jeweiligen Zertifikate.

## International getestet/berechnet/zertifiziert:



- 1 Perfekt für öffentliche Einrichtungen mit hohen Sicherheitsanforderungen, wie Stadien.
- 2 Montage direkt auf Beton, ohne dass eine Stahlkonstruktion erforderlich ist.



## EASY GLASS® MAX MONTAGEOPTIONEN

### Max Bodenmontage

- Auch für In-Bodenmontage geeignet

### Max F Bodenmontage

- Für Rohfußböden
- Kann direkt an oder über der Bodenkante angebracht werden

### Max Seitenmontage

- Bodenprofil-Blendleiste erhältlich

### Max Y Seitenmontage

- Für Rohfußböden
- Kann direkt an oder über der Bodenkante angebracht werden
- Optionale Bodenprofil-Blendleiste

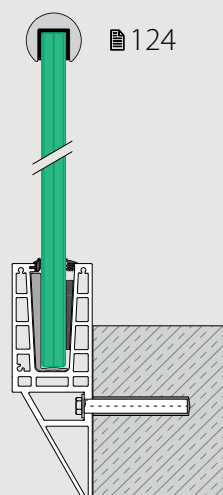
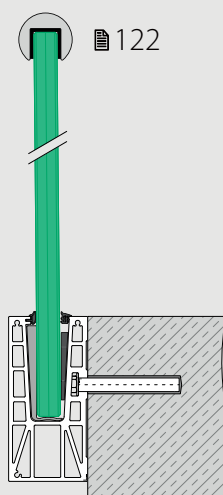
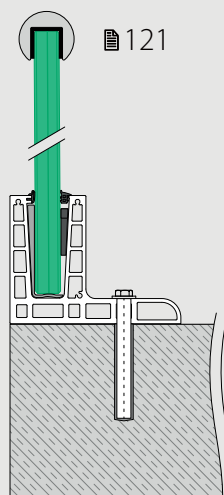
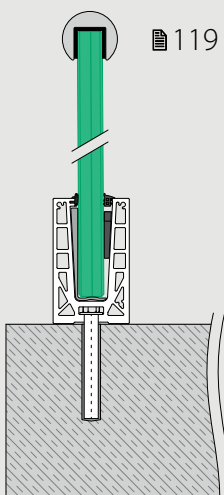



Geländerbasis

Safety Wedge System (Gummi- und Keilsets)

Glasklemmung (nicht justierbar)

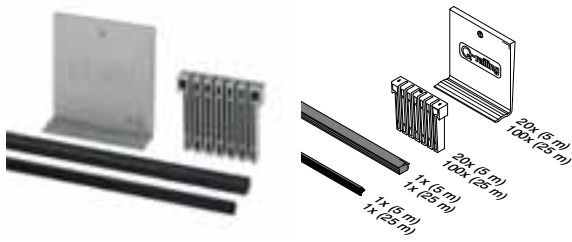

MOD 8500

Zubehör		
Für monolithisches Glas		
208500-050-19	19	L = 5 m
208500-050-25	25	L = 5 m
Für laminiertes Glas		
208500-050-21	20,76	L = 5 m
208500-050-22	21,52	L = 5 m
208500-050-24	24,76	L = 5 m
208500-050-26	25,52	L = 5 m
208500-050-32	31,52	L = 5 m
Für monolithisches Glas		
208500-250-19	19	L = 25 m
Für laminiertes Glas		
208500-250-21	20,76	L = 25 m
208500-250-22	21,52	L = 25 m
208500-250-24	24,76	L = 25 m
208500-250-26	25,52	L = 25 m
208500-250-32	31,52	L = 25 m

Internationaler Geschmacksmusterschutz

Zubehör

Easy Glass® Multitool



MOD 1001

Zubehör		
201001	Q-71	1

Zubehör

Einzelne Gummis



MOD 8506

Zubehör		
208506-250-00		L = 25 m

NEW



MOD 8506

Zubehör		
Für monolithisches Glas		
208506-250-19	19	L = 25 m
Für laminiertes Glas		
208506-250-22	20,76 - 21,52	L = 25 m
208506-250-26	24,76 - 25,52	L = 25 m
208506-250-32	31,52	L = 25 m

NEW

Geländerbasis

Trenngummi

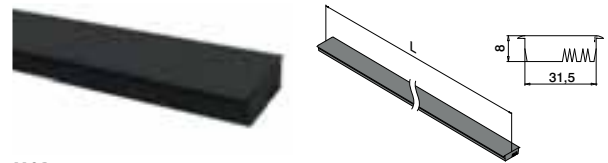

MOD 8505

Zubehör		
208505-025		L = 2,5 m



Q-INFO MOD 8500

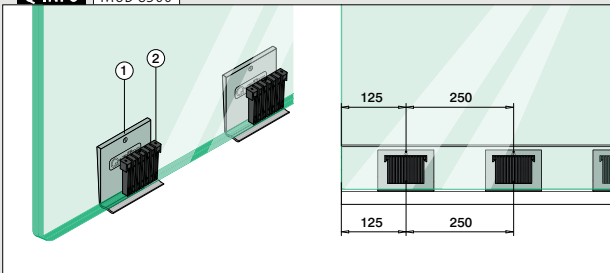

Q-INFO MOD 1001

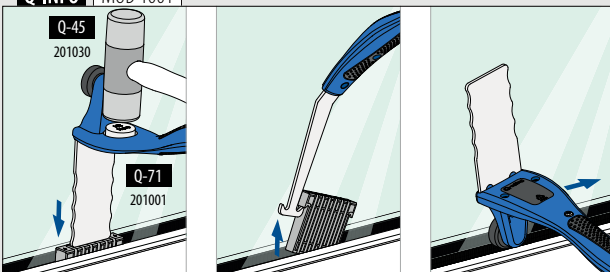

Q-INFO MOD 8505

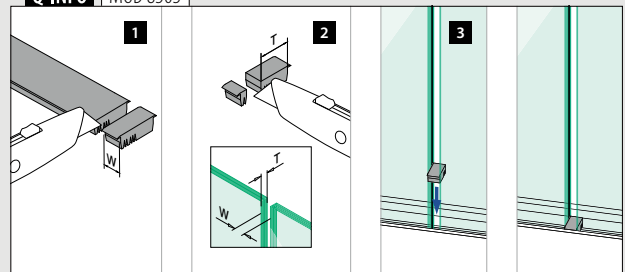

Bodenprofile zur Bodenmontage

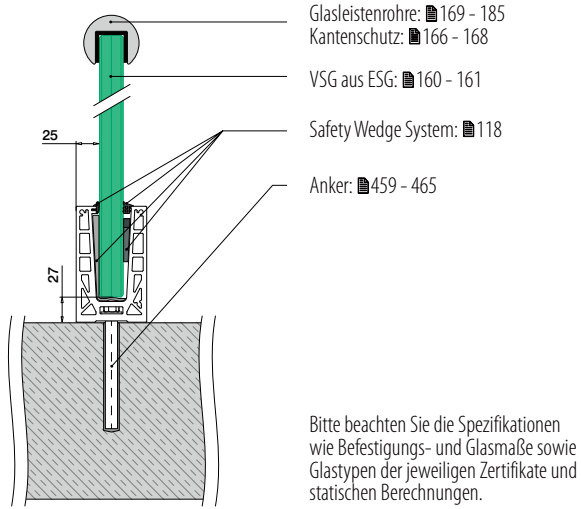

Glasleistenrohre: 169 - 185  
Kantenschutz: 166 - 168  
VSG aus ESG: 160 - 161  
Safety Wedge System: 118  
Anker: 459 - 465

Bitte beachten Sie die Spezifikationen wie Befestigungs- und Glasmaße sowie Glastypen der jeweiligen Zertifikate und statischen Berechnungen.

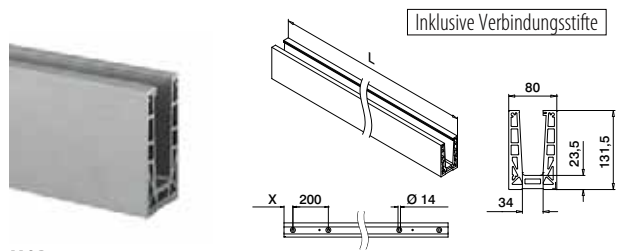

MOD 8510

Aluminium Roh

	X		
NEW 168510-025-00-00	50	459 - 465	L = 2,5 m
NEW 168510-050-00-00	100	459 - 465	L = 5 m

Aluminium Gebürstet

OUTDOOR			
168510-025-00-18	50	459 - 465	L = 2,5 m
NEW 168510-050-00-18	100	459 - 465	L = 5 m



Internationaler Geschmacksmusterschutz

Ecken zur Bodenmontage

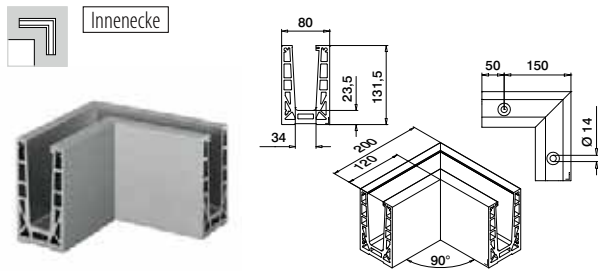

MOD 8511

Aluminium Gebürstet

OUTDOOR			
168511-01-18		459 - 465	1

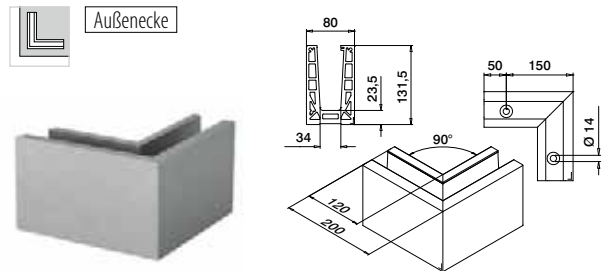

MOD 8511

Aluminium Gebürstet

OUTDOOR			
168511-02-18		459 - 465	1



Verbindungsstifte

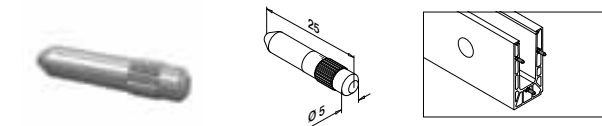

MOD 3005

V4A 316 Roh

OUTDOOR			
143005			6



Q-INFO MOD 8510

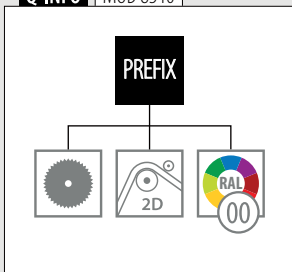

Q-INFO MOD 8510

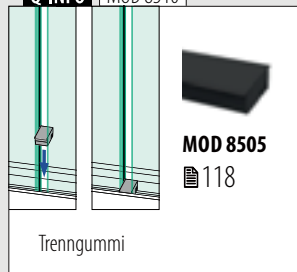

Q-INFO Aluminium



Geländerbasis

Endkappen zur Bodenmontage

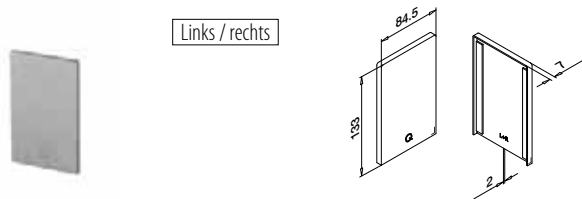

Links / rechts

**MOD 8512**

<b>Aluminium</b>	Gebürstet		
<b>OUTDOOR</b>	<b>Klebeband</b>		
168512-00-18	Angebracht	1	

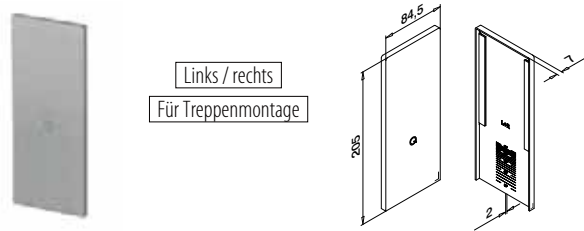

Links / rechts  
Für Treppenmontage

**MOD 8513**

<b>Aluminium</b>	Gebürstet		
<b>OUTDOOR</b>	<b>Klebeband</b>		
168513-00-18	Angebracht	1	



Geländerbasis

Unterlegscheiben zur Bodenmontage

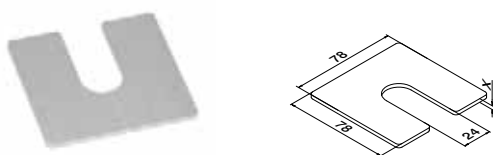

**MOD 8516**

<b>Aluminium</b>	Roh		
	<b>X</b>		
168516-001	1	100	
168516-002	2	100	
168516-003	3	100	

**Q-INFO** | MOD 8516

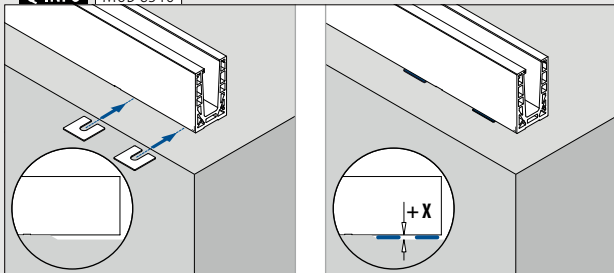

**Q-INFO** | MOD 8512

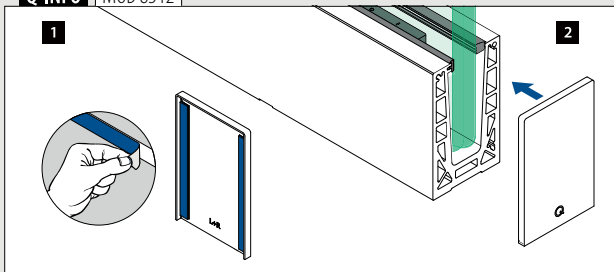

**Q-INFO** | MOD 8513

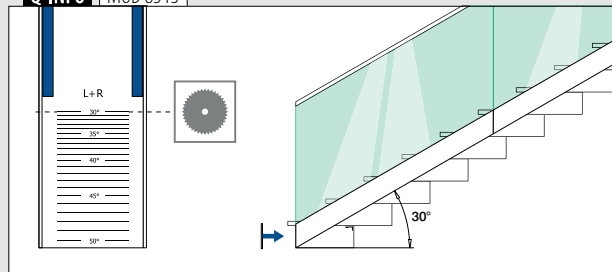

Bodenprofile zur Bodenmontage

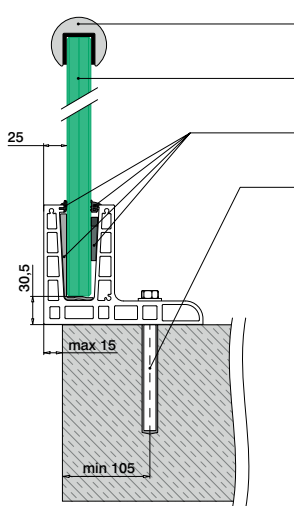

- Glasleistenrohre: ■ 169 - 185
- Kantenschutz: ■ 166 - 168
- VSG aus ESG: ■ 160 - 161
- Safety Wedge System: ■ 118
- Anker: ■ 459 - 465

Bitte beachten Sie die Spezifikationen wie Befestigungs- und Glasmaße sowie Glasstypen der jeweiligen Zertifikate und statischen Berechnungen.

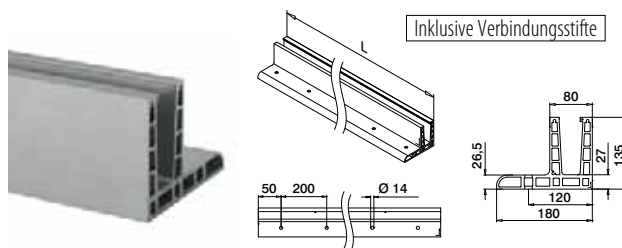

MOD 8520

Aluminium Gebürstet

OUTDOOR

168520-025-00-18 ■ 459 - 465 L = 2,5 m



Internationaler Geschmacksmusterschutz

Ecken zur Bodenmontage

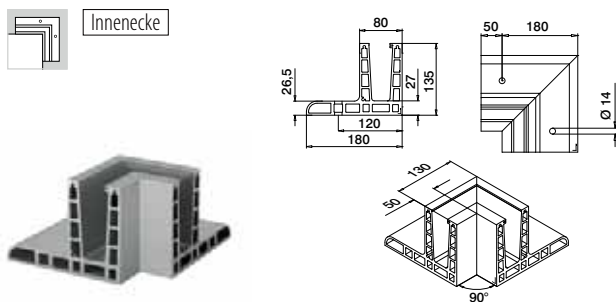

MOD 8521

Aluminium Gebürstet

OUTDOOR

168521-01-18 ■ 459 - 465



1

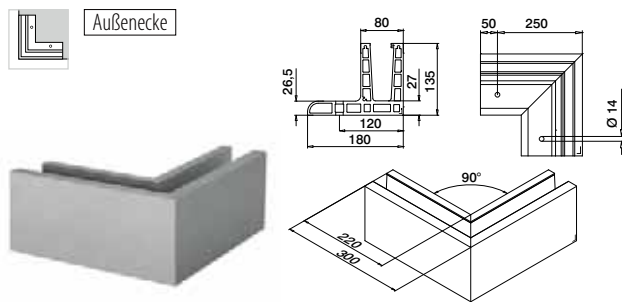

MOD 8521

Aluminium Gebürstet

OUTDOOR

168521-02-18 ■ 459 - 465



1



Endkappen zur Bodenmontage

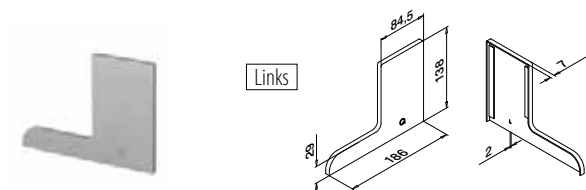

MOD 8522

Aluminium Gebürstet

OUTDOOR

Klebeband

168522-01-18 Angebracht



1

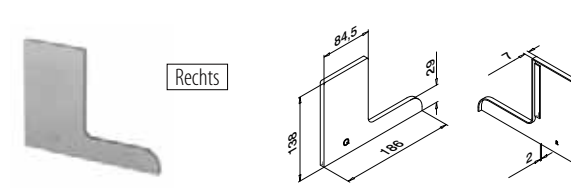

MOD 8522

Aluminium Gebürstet

OUTDOOR

Klebeband

168522-02-18 Angebracht



1

Q-INFO MOD 8520

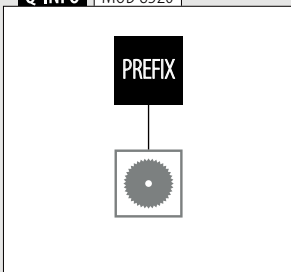

Q-INFO MOD 8520

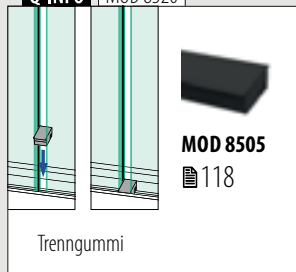

Q-INFO MOD 8522

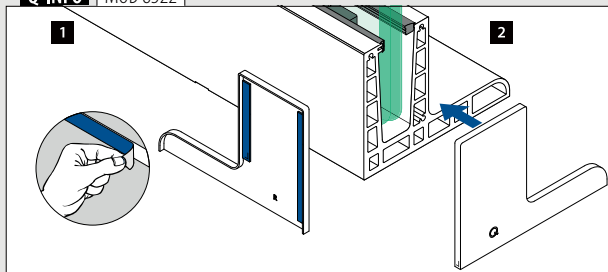



Geländerbasis

Bodenprofile zur Seitenmontage

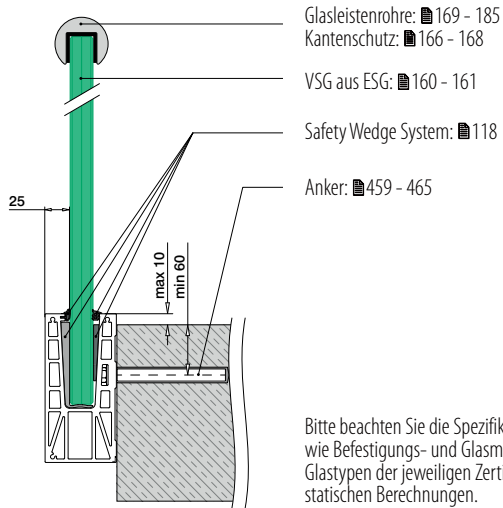

Bitte beachten Sie die Spezifikationen wie Befestigungs- und Glasmaße sowie Glasstypen der jeweiligen Zertifikate und statischen Berechnungen.

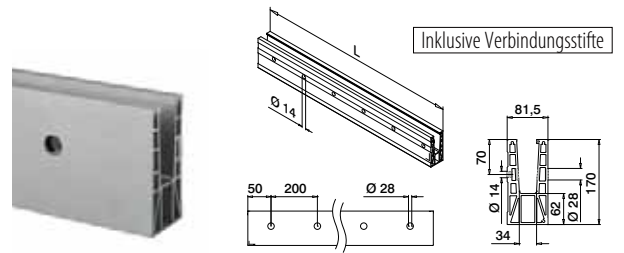

**MOD 8530**

**Aluminium** Gebürstet

**OUTDOOR**

168530-025-00-18 459 - 465 L = 2,5 m



Internationaler Geschmacksmusterschutz

Geländerbasis

Ecken zur Seitenmontage

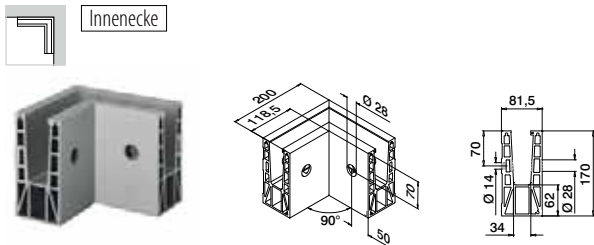

**MOD 8531**

**Aluminium** Gebürstet

**OUTDOOR**

168531-01-18 459 - 465 1

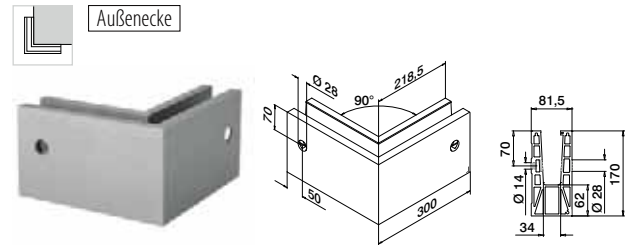

**MOD 8531**

**Aluminium** Gebürstet

**OUTDOOR**

168531-02-18 459 - 465 1



**Q-INFO** MOD 8530

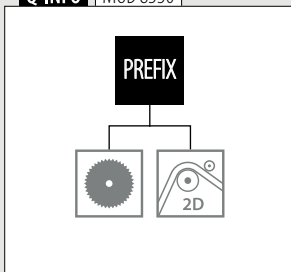

**Q-INFO** MOD 8530

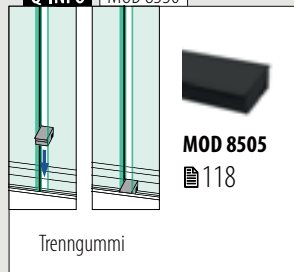

Endkappen zur Seitenmontage



Links

MOD 8532

<b>Aluminium</b>	Gebürstet	
<b>OUTDOOR</b>	<b>Kleband</b>	
168532-01-18	Angebracht	1



Rechts

MOD 8532

<b>Aluminium</b>	Gebürstet	
<b>OUTDOOR</b>	<b>Kleband</b>	
168532-02-18	Angebracht	1

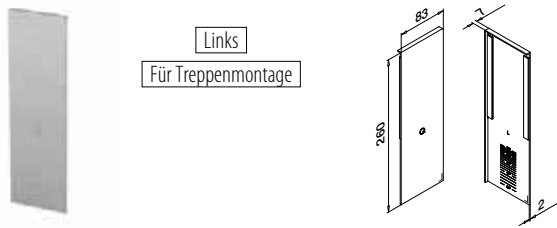

Links

Für Treppenmontage

MOD 8533

<b>Aluminium</b>	Gebürstet	
<b>OUTDOOR</b>	<b>Kleband</b>	
168533-01-18	Angebracht	1

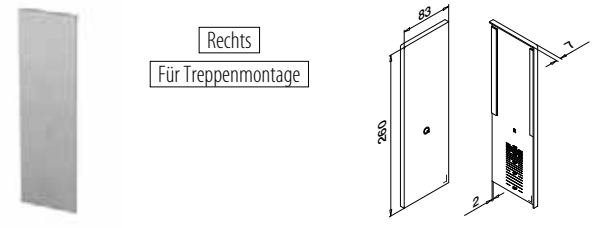

Rechts

Für Treppenmontage

MOD 8533

<b>Aluminium</b>	Gebürstet	
<b>OUTDOOR</b>	<b>Kleband</b>	
168533-02-18	Angebracht	1



Blendleisten zur Seitenmontage

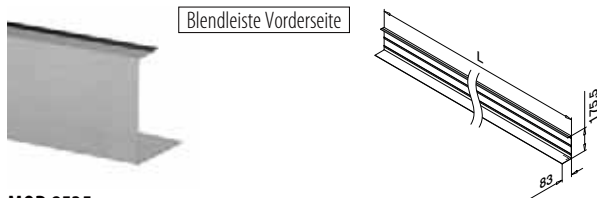

Blendleiste Vorderseite

MOD 8535

<b>Aluminium</b>	Gebürstet	
<b>OUTDOOR</b>	<b>Kleband</b>	
168535-050-18	Angebracht	L = 5 m



Blendstopfen zur Seitenmontage

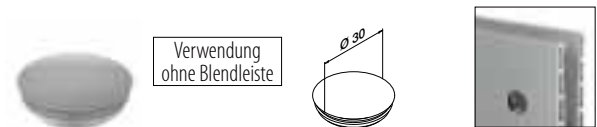

Verwendung ohne Blendleiste

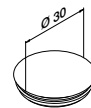

MOD 8538

<b>Kunststoff</b>	Aluminium RAL 9006	
<b>INDOOR</b>		
158538-36		10

Q-INFO MOD 8532 / 8533

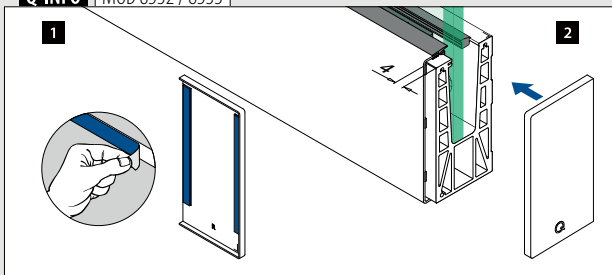

Q-INFO MOD 8533

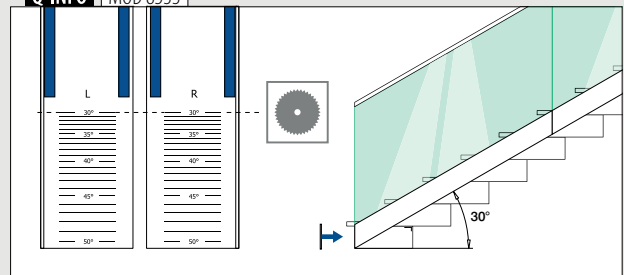

Q-INFO MOD 8535

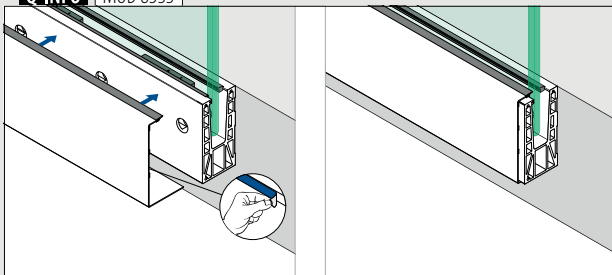

Q-INFO MOD 8538

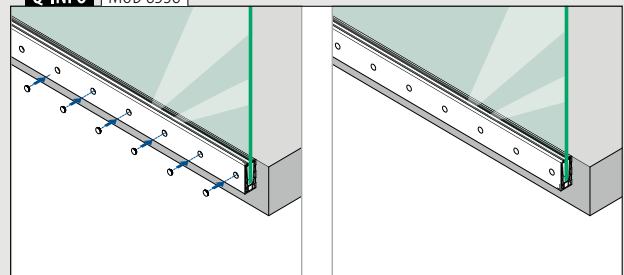

Geländerbasis

Bodenprofile zur Seitenmontage

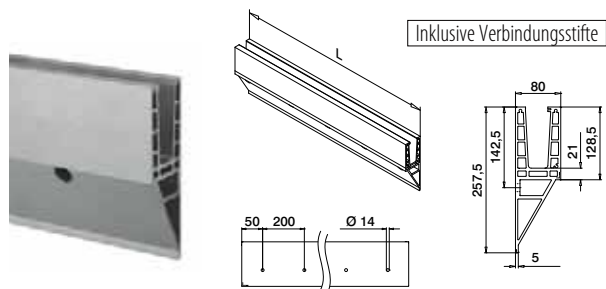
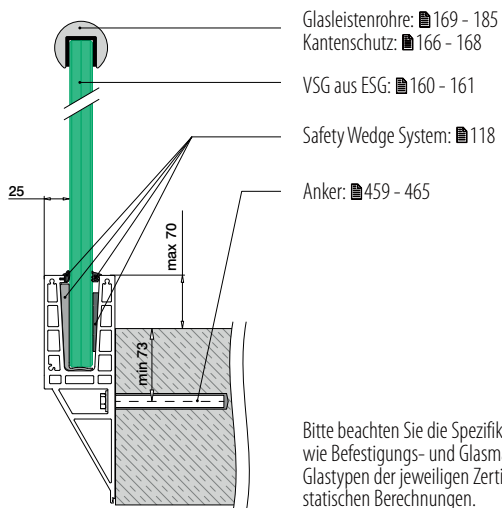

**MOD 8540**

**Aluminium** Gebürstet

**OUTDOOR**

168540-025-00-18 459 - 465 L = 2,5 m



Internationaler Geschmacksmusterschutz

Geländerbasis

Ecken zur Seitenmontage

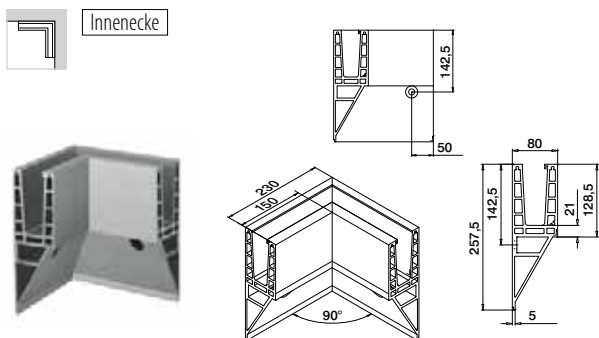

**MOD 8541**

**Aluminium** Gebürstet

**OUTDOOR**

168541-01-18 459 - 465 1

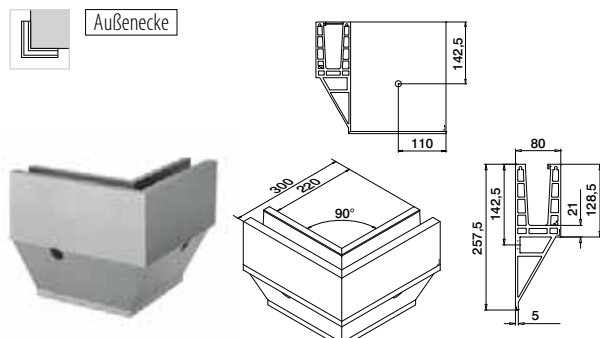

**MOD 8541**

**Aluminium** Gebürstet

**OUTDOOR**

168541-02-18 459 - 465 1



**Q-INFO** MOD 8540

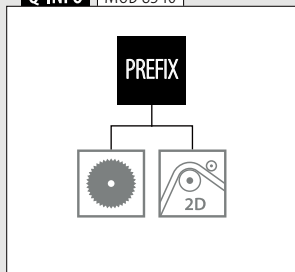

**Q-INFO** MOD 8540

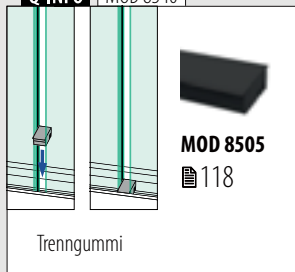

## Endkappen zur Seitenmontage

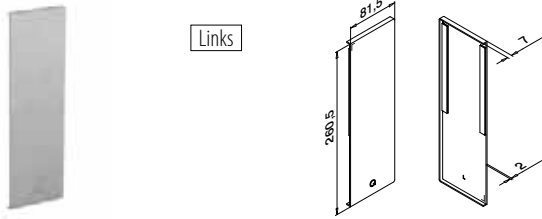

## MOD 8542

<b>Aluminium</b>	Gebürstet		
<b>OUTDOOR</b>	<b>Klebeband</b>		
168542-01-18	Angebracht	1	

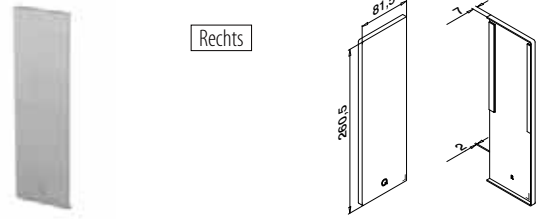

## MOD 8542

<b>Aluminium</b>	Gebürstet		
<b>OUTDOOR</b>	<b>Klebeband</b>		
168542-02-18	Angebracht	1	

## Blendleisten zur Seitenmontage

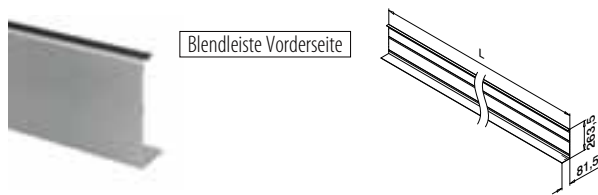

## MOD 8545

<b>Aluminium</b>	Gebürstet		
<b>OUTDOOR</b>	<b>Klebeband</b>		
168545-050-18	Angebracht	L = 5 m	



## Q-INFO MOD 8542

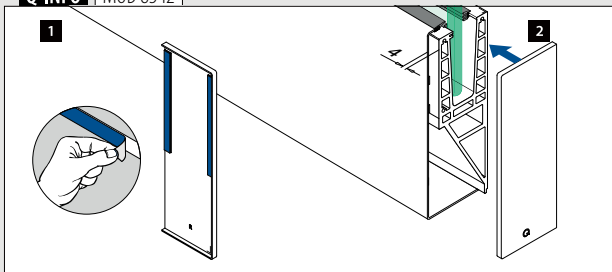

## Q-INFO MOD 8545

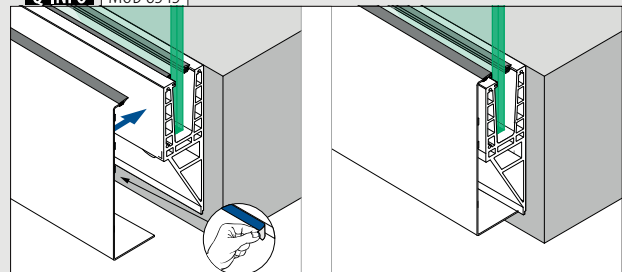





- Beanspruchung:** Leicht und mittel  
**Verwendung:** Innen- und Außenbereich  
**Varianten:** Boden, In-Boden- und Seitenmontage  
**Anwendung:** Balkone, Galerien und Dachterrassen  
**Material:** Aluminium (roh oder gebürstet anodisiert)  
**Glasstärke:** 12 bis 17,52 mm, max. 700 mm hoch

Finden Sie alle Informationen zu Easy Glass Up online:

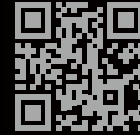

<https://q-ne.ws/Up23>

# EASY GLASS<sup>®</sup> UP

# Ungestörte Sicht - Die ideale Lösung für Aufkantungen

Easy Glass® Up ist die ultimative Lösung für Bereiche, die von Aufmauerungen umschlossen sind. Die ultraschlanken Bodenprofile – entweder für die Boden- oder Seitenmontage – sorgen für eine ungestörte Sicht. Mit Up können Sie Balkongeländer mit bis zu 700 mm hohen Glasfüllungen errichten. So bereichern Sie jede Dachterrasse.



Easy Glass® Up	DE
Max. Holmlast (kN/m)	1,0



Bitte beachten Sie die Spezifikationen wie Befestigungs- und Glasmaße sowie Glastypen der jeweiligen Zertifikate.

International getestet/berechnet/zertifiziert:



- 1 Mit einem nur 80 mm hohen bodenmontierten Profil ermöglicht Up eine perfekte Aussicht von jedem Balkon oder jeder Terrasse mit Aufmauerungen.
- 2 Sie können alles bequem von der Innenseite aus montieren.



## EASY GLASS® UP MONTAGEOPTIONEN

### Up Bodenmontage

- Für Aufmauerungen
- Auch für die In-Bodenmontage geeignet

130

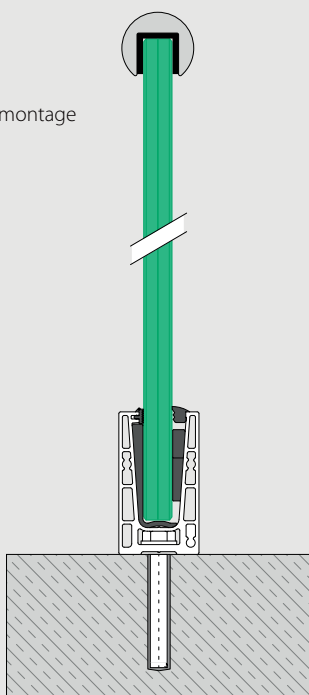

### Up Seitenmontage

- Für Aufmauerungen (inverse Montage)
- Optionale Bodenprofil-Blendleiste

131

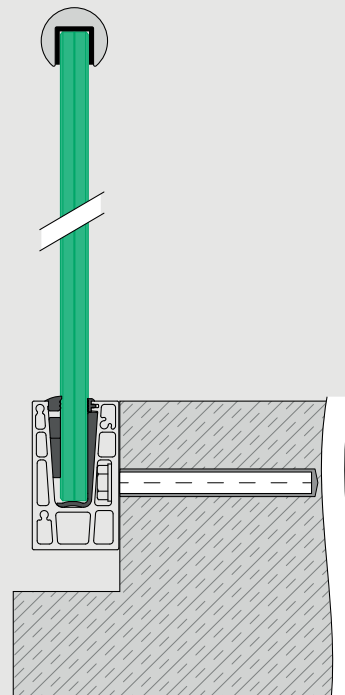

Geländerbasis

Safety Wedge System (Gummi- und Keilsets)

Glasklemmung (nicht justierbar)

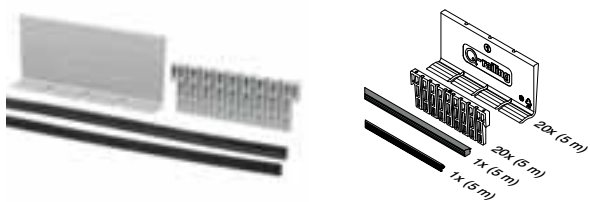

MOD 6600

Zubehör

Für monolithisches Glas		T	
206600-050-12	12	L = 5 m	
206600-050-15	15	L = 5 m	

Für laminiertes Glas

206600-050-13	12,76	L = 5 m
206600-050-14	13,52	L = 5 m
206600-050-17	16,76	L = 5 m
206600-050-18	17,52	L = 5 m

Zubehör

Easy Glass® Multitool



MOD 1001

Zubehör

		Q	
201001	Q-71		1

Geländerbasis

Verbindungsstifte

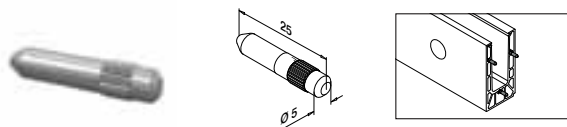

MOD 3005

V4A	316	Roh	
			<b>OUTDOOR</b>
143005			
			6



Q-INFO MOD 6600

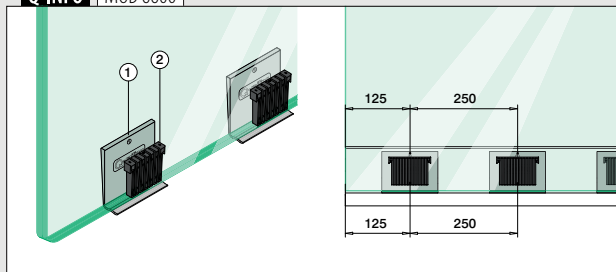

Q-INFO MOD 1001

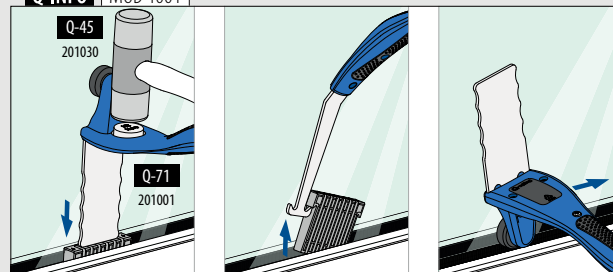







Geländerbasis

Bodenprofile zur Bodenmontage

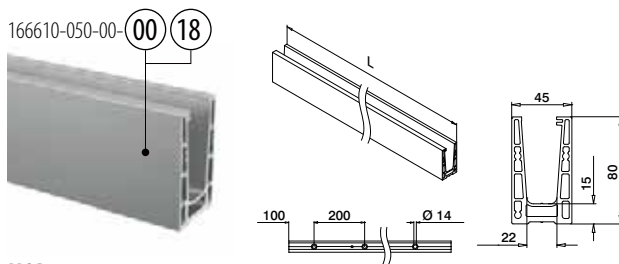
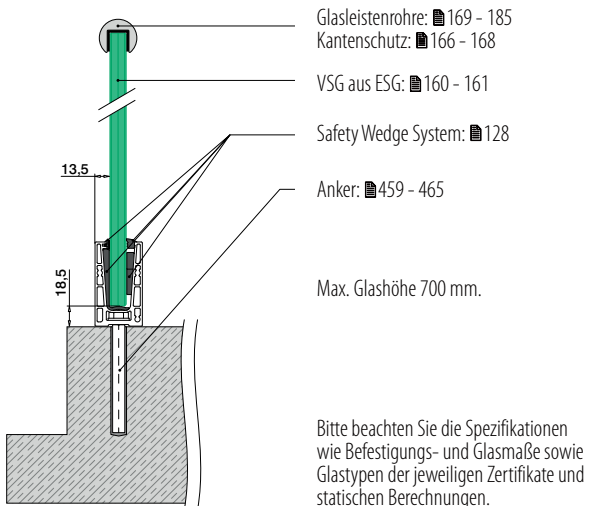

MOD 6610

<b>Aluminium</b>	Roh		
166610-050-00-00	█ 459 - 465	L = 5 m	
<b>Aluminium</b>	Gebürstet		
166610-050-00-18	█ 459 - 465	L = 5 m	



Geländerbasis

Ecken zur Bodenmontage

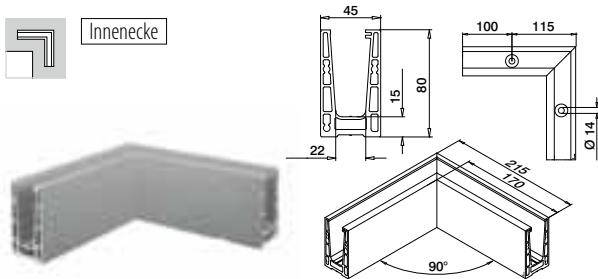

MOD 6611

<b>Aluminium</b>	Gebürstet		
166611-01-18	█ 459 - 465	1	

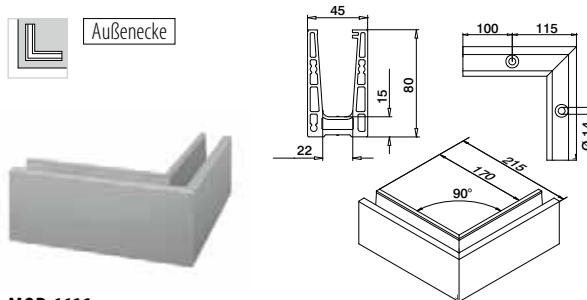

MOD 6611

<b>Aluminium</b>	Gebürstet		
166611-02-18	█ 459 - 465	1	



Geländerbasis

Endkappen zur Bodenmontage

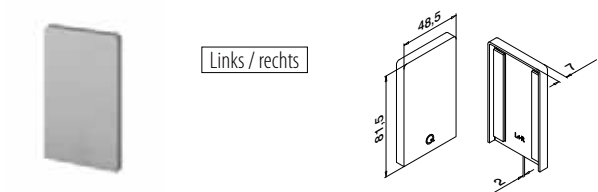

MOD 6612

<b>Aluminium</b>	Roh	
166612-00-00	Beigelegt	1
<b>Aluminium</b>	Gebürstet	
166612-00-18	Angebracht	1

**Q-INFO** MOD 6610

**Q-INFO** MOD 6610 / 6611

**MOD 3005**  
█ 128

Zusätzliche Verbindungsstifte

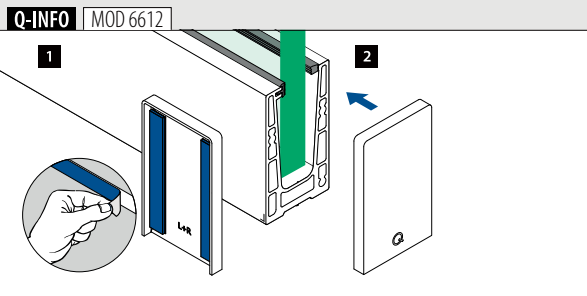

Bodenprofile zur Seitenmontage

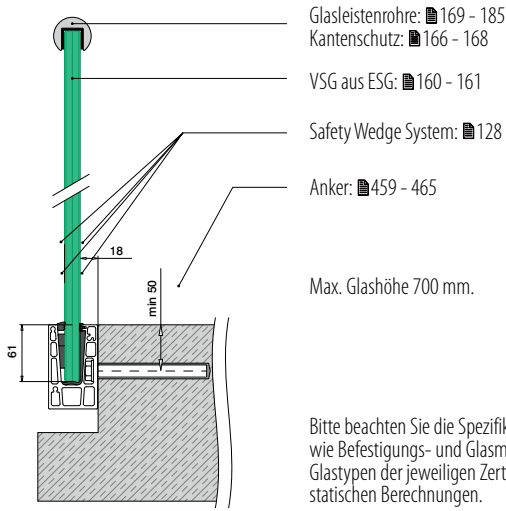

Bitte beachten Sie die Spezifikationen wie Befestigungs- und Glasmaße sowie Glastypen der jeweiligen Zertifikate und statischen Berechnungen.

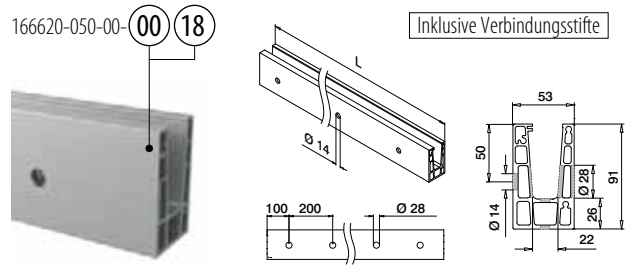

MOD 6620

<b>Aluminium</b>	Roh	X		
166620-050-00-00	100	459 - 465	L = 5 m	

<b>Aluminium</b>	Gebürstet			
<b>OUTDOOR</b>				
166620-050-00-18	100	459 - 465	L = 5 m	



Ecken zur Seitenmontage

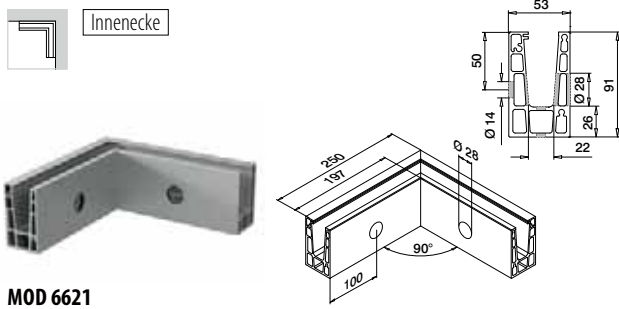

MOD 6621

<b>Aluminium</b>	Gebürstet			
<b>OUTDOOR</b>				
166621-01-18	459 - 465	1		

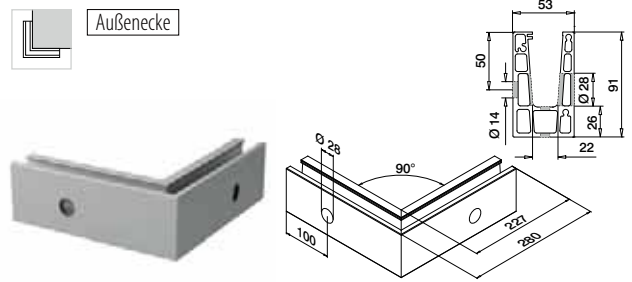

MOD 6621

<b>Aluminium</b>	Gebürstet			
<b>OUTDOOR</b>				
166621-02-18	459 - 465	1		



Q-INFO MOD 6620

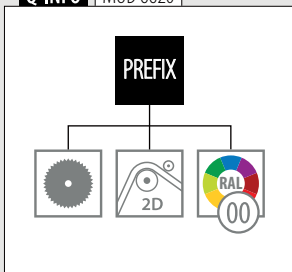

Q-INFO Aluminium

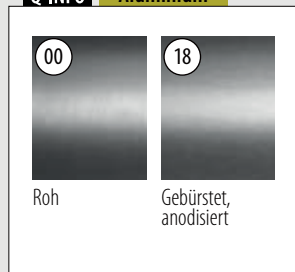

Q-INFO

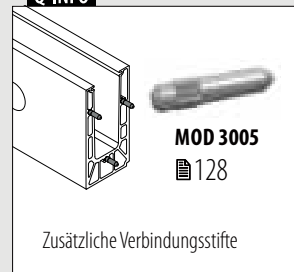

Geländerbasis

Endkappen zur Seitenmontage

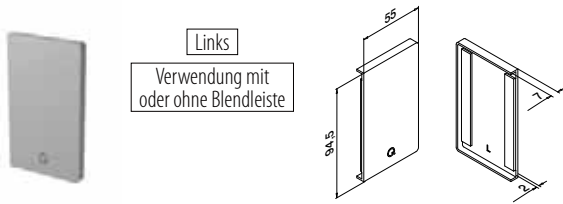

MOD 6622

<b>Aluminium</b>	Roh		
		<b>Klebeband</b>	
166622-01-00		Beigelegt	1
<b>Aluminium</b>	Gebürstet		
<b>OUTDOOR</b>			
166622-01-18		Angebracht	1

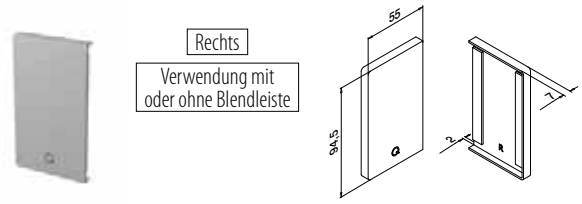

MOD 6622

<b>Aluminium</b>	Roh		
		<b>Klebeband</b>	
166622-02-00		Beigelegt	1
<b>Aluminium</b>	Gebürstet		
<b>OUTDOOR</b>			
166622-02-18		Angebracht	1

Geländerbasis

Blendleisten zur Seitenmontage



MOD 6625

<b>Aluminium</b>	Roh		
		<b>Klebeband</b>	
166625-050-00		Nicht inkl.*	L = 5 m
<b>Aluminium</b>	Gebürstet		
<b>OUTDOOR</b>			
166625-050-18		Angebracht	L = 5 m



\*Bestellen Sie MOD 1360 (Klebeband)

Zubehör

Acrylat-Klebeband



MOD 1360

	<b>Zubehör</b>			
	<b>Q</b>	<b>W</b>	<b>L</b>	
201360	Q-53	9	33 m (für 11 m Blendleiste)	1

Q-INFO | MOD 6625

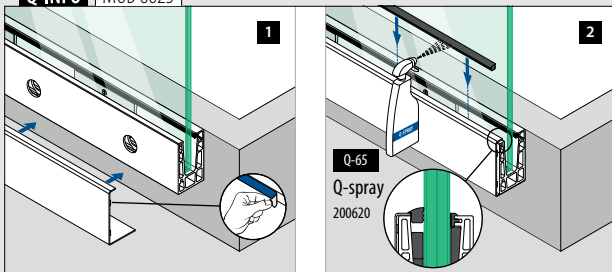

Q-INFO | MOD 6625-050-00 / 1360



Q-INFO | Aluminium

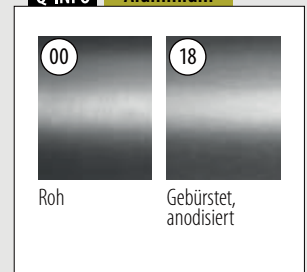

## Drainageleisten zur Seitenmontage

8 Stück für 5-Meter-Bodenprofil

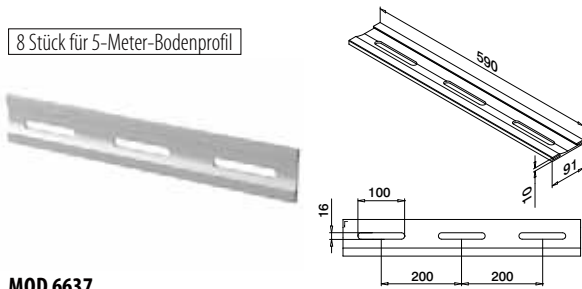

## MOD 6637

Aluminium Gebürstet  
OUTDOOR

166637-18



4

## Unterlegscheiben zur Seitenmontage

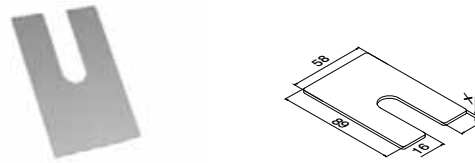

## MOD 6636

Aluminium Roh

	X	
166636-001	1	100
166636-002	2	100
166636-003	3	100

## Blendstopfen zur Seitenmontage

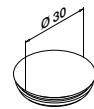
Verwendung  
ohne Blendeiste

## MOD 8538

Kunststoff Aluminium RAL 9006  
INDOOR

158538-36



10

## Q-INFO MOD 6637

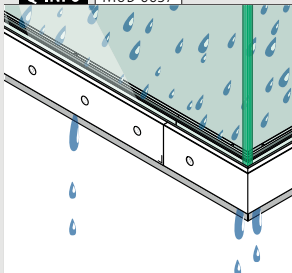

Montage-Informationen:

<https://q-ne.ws/Up23>

## Q-INFO MOD 8538

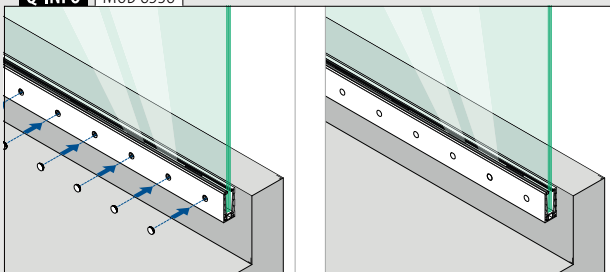

## Q-INFO MOD 6636

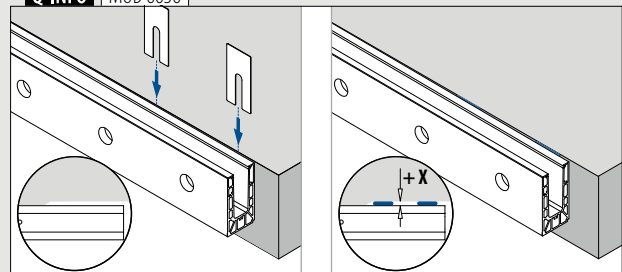





**Beanspruchung:** Leicht und mittel  
**Verwendung:** Innen- und Außenbereich  
**Varianten:** Montage zwischen Wänden  
**Anwendung:** Balkone und französische Balkone  
**Material:** Aluminium (roh, matt Silbereffekt, gebürstet anodisiert oder pulverbeschichtet in RAL 9005 schwarz), Stahl (pulverbeschichtet RAL 7047 oder KTL-beschichtet), Edelstahl (gebürstet oder pulverbeschichtet RAL 9005 schwarz)  
**Glasstärke:** 8 bis 13,52 mm

Finden Sie alle Informationen zu Easy Glass Hybrid online:



<https://q-ne.ws/Hybrid23>

# EASY GLASS® HYBRID

# Das minimalistische Balkongeländer



Wenn Sie ein Geländer zwischen zwei Wänden anbringen möchten, zum Beispiel auf einem nicht auskragenden Balkon, ist Easy Glass® Hybrid die ideale Lösung. Mit einem minimalistischen Bodenprofil und robusten Wandanschlüssen schafft dieses System eine transparente und dennoch starke Struktur für Spannweiten von bis zu 3.200 mm.

Easy Glass® Hybrid	DE
Max. Holmlast (kN/m)	0,5
Max. Breite (Meter)	3,2

STATISCHE  
BERECHNUNG  
DIN18008

AbP  
BALAUST  
GEPÜFT

Bitte beachten Sie die Spezifikationen wie Befestigungs- und Glasmaße sowie Glastypen der jeweiligen Zertifikate.

International getestet/berechnet/zertifiziert:



- 1 Die perfekte Lösung für nicht auskragende Balkone. Hybrid ist das minimalistischste Glasgeländer zur Montage zwischen zwei Wänden.
- 2 Schaffen Sie ununterbrochene Glasbreiten von bis zu 3.200 mm.
- 3 Hybrid bietet ein modernes Design für Bodenprofil und Handlauf.



## EASY GLASS® HYBRID

**Hybrid**  
Bodenmontage

- Montage zwischen zwei Wänden

136

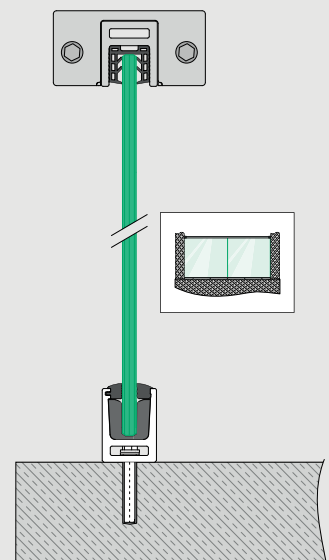

Geländerbasis

Bodenprofile zur Bodenmontage - zwischen zwei Wänden

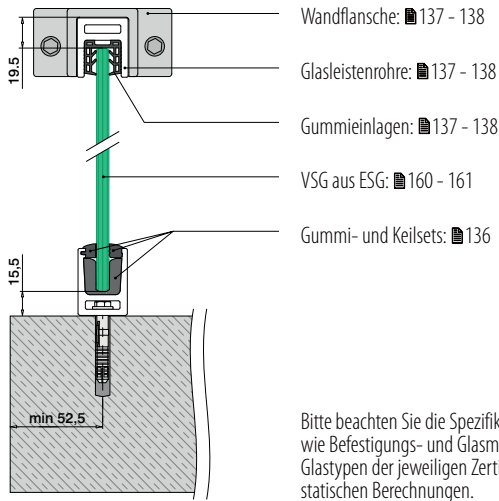

Bitte beachten Sie die Spezifikationen wie Befestigungs- und Glasmaße sowie Glastype der jeweiligen Zertifikate und statischen Berechnungen.

Geländerbasis

Endkappen



MOD 6912

<b>Aluminium</b>	Roh		
<b>Kleband</b>			
166912-00-00	Beigelegt		2
<b>Aluminium</b>	Matt Silbereffekt		
<b>OUTDOOR</b>			
<b>SELL OUT</b>	166912-00-08	Angebracht	2
<b>Aluminium</b>	Gebürstet		
<b>OUTDOOR</b>			
<b>NEW</b>	166912-00-18	Angebracht	2
<b>Aluminium</b>	<b>Black Line</b>		
<b>OUTDOOR</b>			
<b>NEW</b>	166912-00-82	Beigelegt	2

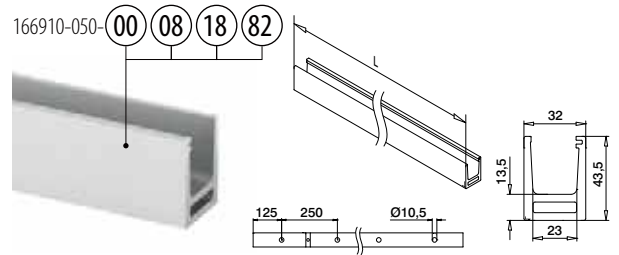

MOD 6910

<b>Aluminium</b>	Roh		
166910-050-00	QS-213	470	L = 5 m
<b>Aluminium</b>	Matt Silbereffekt		
<b>OUTDOOR</b>			
<b>SELL OUT</b>	166910-050-08	QS-213	470 L = 5 m
<b>Aluminium</b>	Gebürstet		
<b>OUTDOOR</b>			
<b>NEW</b>	166910-050-18	QS-213	470 L = 5 m
<b>Aluminium</b>	<b>Black Line</b>		
<b>OUTDOOR</b>			
<b>NEW</b>	166910-050-82	QS-213	470 L = 5 m

**PREFIX** **STATISCHE BERECHNUNG** **AbP** Internationaler Geschmacksmusterschutz

Geländerbasis

Gummi- und Keilsets

Glasklemmung (nicht justierbar)

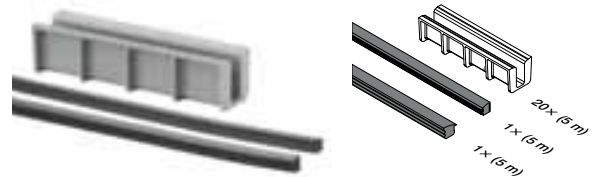

MOD 6910

<b>Zubehör</b>			
Für monolithisches Glas		<b>T</b>	
206910-08	8		L = 5 m
206910-10	10		L = 5 m
Für laminiertes Glas			
206910-08	8,76 - 9,52		L = 5 m
206910-10	10,76 - 11,52		L = 5 m
206910-13	12,76 - 13,52		L = 5 m

Internationaler Geschmacksmusterschutz

Q-INFO MOD 6910

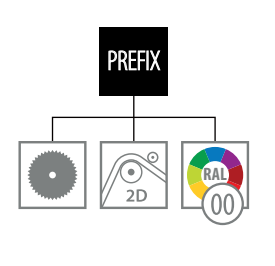

Q-INFO MOD 6912

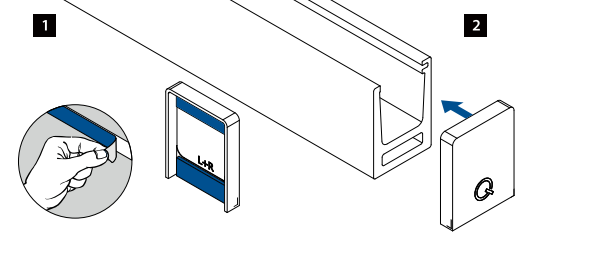

**SELL OUT** Nur solange der Vorrat reicht.

Q-INFO Aluminium

<b>00</b>	<b>08</b>	<b>18</b>	<b>82</b> RAL 9005
Roh	Mattsilbereffekt	Gebürstet, anodisiert	Pulverbeschichtet

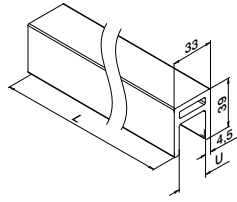
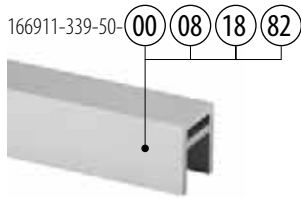

**MOD 6911**

<b>Aluminium</b>	Roh		
		<b>U</b>	
166911-339-50-00	24		L = 5 m
<b>Aluminium</b>	Matt Silbereffekt		
		<b>OUTDOOR</b>	
<b>SELL OUT</b>	166911-339-50-08	24	L = 5 m
<b>Aluminium</b>	Gebürstet		
		<b>OUTDOOR</b>	
<b>NEW</b>	166911-339-50-18	24	L = 5 m
<b>Aluminium</b>	Black Line		
		<b>OUTDOOR</b>	
<b>NEW</b>	166911-339-50-82	24	L = 5 m



Internationaler Geschmacksmusterschutz

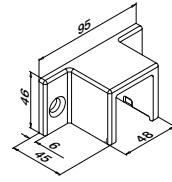

**MOD 6515**

<b>V4A</b>	<b>316</b>	Gebürstet	
		<b>OUTDOOR</b>	
	146515-339-12	QS-214 470	2
<b>V4A</b>	<b>316</b>	Black Line	
		<b>OUTDOOR</b>	
	146515-339-82	QS-214 470	2

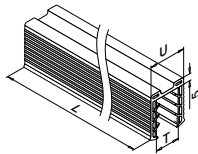

**MOD 5124**

	<b>Zubehör</b>		
		<b>U = 24 mm</b>	
	Für monolithisches Glas	<b>T</b>	
	205124-050-08	8 - 10	L = 5 m
	Für laminiertes Glas		
	205124-050-08	8,76 - 10,76	L = 5 m
	205124-050-11	11,52 - 13,52	L = 5 m

**Q-INFO MOD 6911**

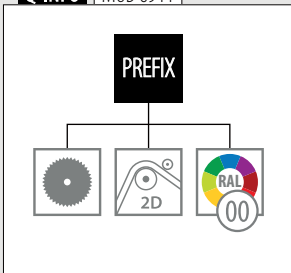

**Q-INFO 316**



**Q-INFO**

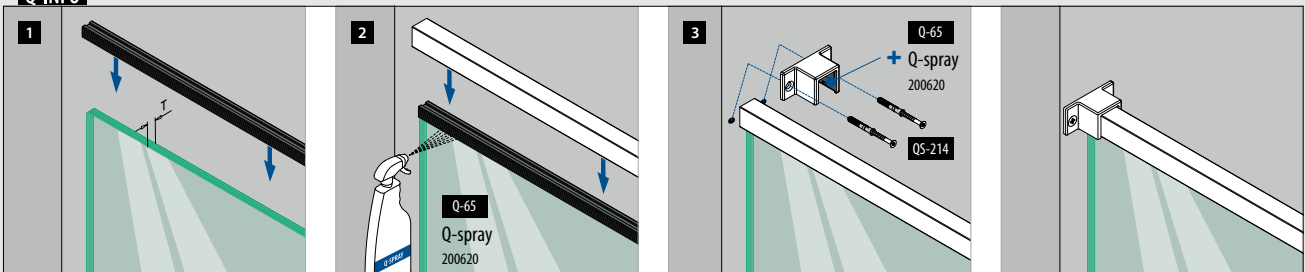



Glasleistenrohre

**Glasleistenrohre**

**HYBRID 65x40**

166924-654-50-00 08

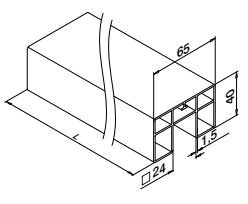
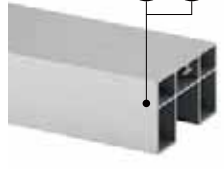

**MOD 6924**

**Aluminium** Roh

166924-654-50-00	65 x 40	L = 5 m
------------------	---------	---------

**Aluminium** Matt Silbereffekt

166924-654-50-08	65 x 40	L = 5 m
------------------	---------	---------

SELL OUT



Internationaler Geschmacksmusterschutz

Glasleistenrohre

**Wandflansche**

**HYBRID 65x40**

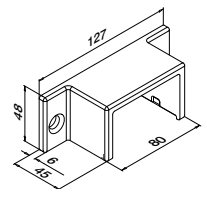

**MOD 6515**

**Stahl** Pulverbeschichtet RAL 7047

116515-654-34	QS-214	470	2
---------------	--------	-----	---

SELL OUT

**Stahl** KTL-beschichtet

116515-654-30	QS-214	470	2
---------------	--------	-----	---

SELL OUT



Glasleistenrohre

**Gummieinlagen**

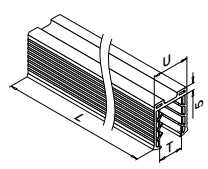

**MOD 5124**

**Zubehör**

U = 24 mm

Für monolithisches Glas	<b>T</b>	
205124-050-08	8 - 10	L = 5 m

Für laminiertes Glas

205124-050-08	8,76 - 10,76	L = 5 m
205124-050-11	11,52 - 13,52	L = 5 m

SELL OUT Nur solange der Vorrat reicht.

**Q-INFO MOD 6924**

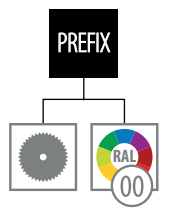

**Q-INFO MOD 6924**



Fügen Sie mithilfe des MOD 6926 Glasleistenrohres eine LED-Beleuchtung (Linear Light) hinzu

**Q-INFO Stahl MOD 6515**

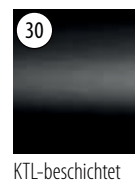

E-coat (KTL), auch elektrophoretische Beschichtung genannt, ist eine dünne Schicht (15 µ), die Stahlprodukten einen Schutzfilm (Grundierung) verleiht. Nach der E-Beschichtung ist das Produkt bereit für die finale Oberflächenbehandlung, beispielsweise eine Lackierung oder eine Pulverbeschichtung.

**Q-INFO**

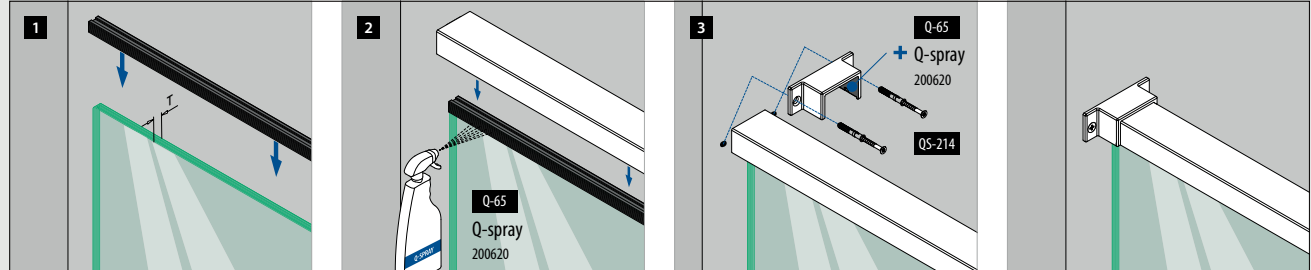





**Verwendung:** Innen- und Außenbereich  
**Anwendung:** Balkone, Galerien, Wege, Abtrennungen und Treppen  
**Material:** Edelstahl (gebürstet, hochglanzpoliert oder pulverbeschichtet RAL 9005 schwarz)  
**Glasstärke:** 12 bis 21,52 mm

Finden Sie alle Informationen zu Easy Glass Bodenglasklemmen online:



<https://q-ne.ws/BaseGlassClamps23>

EASY GLASS®

# BODENGLAS- KLEMMEN

BEEINDRUCKENDE  
OPTIONEN



## MOD 6100

144

- Für leichte Beanspruchung
- Flansch mit Langlöchern
- Befestigung durch das Glas hindurch



## MOD 6200

145

- Für leichte Beanspruchung
- Flansch mit Langlöchern
- Befestigung durch das Glas hindurch

Für Glasgeländer mit einem einzigartigen Look



## MOD 6000

142

- Für leichte Beanspruchung
- Installation mittels eines einzigen Ankers
- Glas wird geklemmt
- Optionaler Sicherungstift
- Integrierte Wasserwaage
- Ohne sichtbare Schrauben



## MOD 6400

143

- Für leichte bis mittlere Beanspruchung
- Installation mittels zwei Anker
- Glas wird geklemmt
- Sicherungstift wird nicht benötigt
- Ohne sichtbare Schrauben

### MOD 6400

Max. Holmlast (kN/m)

DE

1,0

STATISCHE  
BERECH-  
NUNG  
DIN18008

Bitte beachten Sie die Spezifikationen wie Befestigungs- und Glasmaße sowie Glastype der jeweiligen Zertifikate. Für weitere Informationen besuchen Sie [www.q-railing.com/zertifikate](http://www.q-railing.com/zertifikate)

International getestet/berechnet/zertifiziert:





Geländerbasis

Bodenglasklemmen - MOD 6000

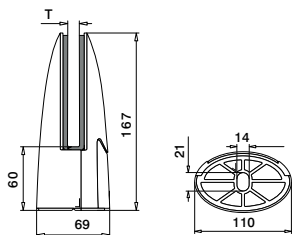

MOD 6000

V4A	316	Gebürstet	T	
<b>OUTDOOR</b>				
146000-12		Siehe T in MOD 5060	459 - 465	1
V4A	316	Hochglanzpoliert	T	
<b>OUTDOOR</b>				
146000-10		Siehe T in MOD 5060	459 - 465	1

Internationaler Geschmacksmusterschutz

Zubehör

Sicherungsstifte

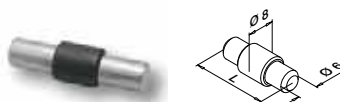

Optional verwendbar für MOD 6000

MOD 5015

Zubehör	L	
205015-24	30	4

Geländerbasis

Gummieinlagen für MOD 6000



2 Stück pro Glasklemme

MOD 5060

Zubehör

Für monolithisches Glas	T	
205060-12	12	2
205060-15	15	2
Für laminiertes Glas		
205060-13	12,76	2
205060-14	13,52	2
205060-17	16,76	2
205060-18	17,52	2

**SELL OUT** Nur solange der Vorrat reicht.

Q-INFO MOD 5015

Optionaler Sicherungsstift. Bitte bestellen Sie Sicherungsstifte und Befestigungsmaterial separat.



MOD 6000

## Bodenglasklemmen - MOD 6400

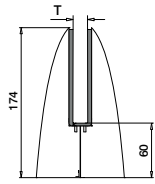
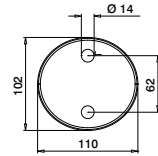
Stahlkern /  
Edelstahlverkleidung

## MOD 6400

V4A	316	Gebürstet			
	<b>OUTDOOR</b>		<b>T</b>		
	146400-12	Siehe T in MOD 5064		459 - 465	1
V4A	316	Hochglanzpoliert			
	<b>OUTDOOR</b>				
SELL OUT	146400-10	Siehe T in MOD 5064		459 - 465	1

Internationaler  
Geschmacksmusterschutz

## Gummieinlagen für MOD 6400

1 Set pro  
Glasklemme

## MOD 5064

## Zubehör

Für monolithisches Glas	T	
205064-15	15	1
205064-19	19	1

## Für laminiertes Glas

205064-17	16,76	1
205064-18	17,52	1
205064-21	20,76	1
205064-22	21,52	1

## Q-INFO 316

10

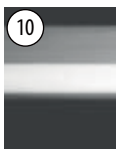
Hochglanz-  
poliert

12



Gebürstet

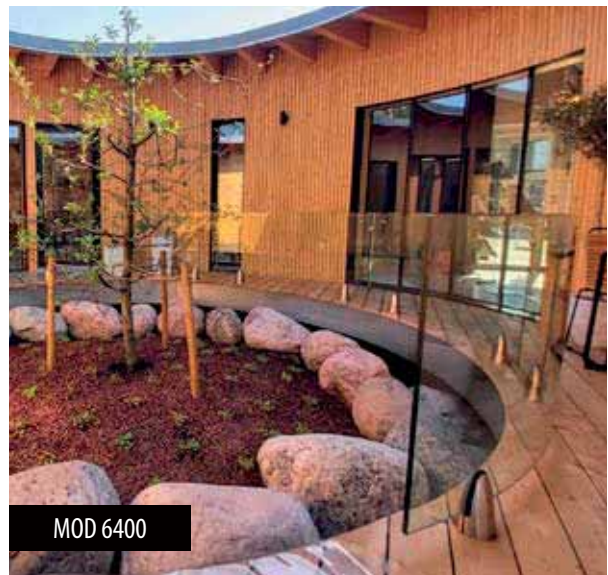

MOD 6400

Geländerbasis

**Bodenglasklemmen - MOD 6100**

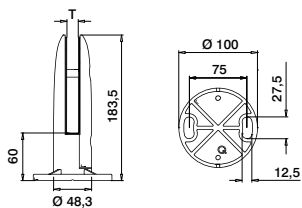

**MOD 6100**

V4A	316	Gebürstet		
	<b>OUTDOOR</b>		<b>T</b>	
	146100-12	Siehe T in MOD 5061	459 - 465	1
V4A	316	Hochglanzpoliert		
	<b>OUTDOOR</b>			
SELL OUT	146100-10	Siehe T in MOD 5061	459 - 465	1



Geländerbasis

**Abdeckkappen für MOD 6100**

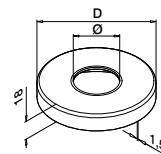

**MOD 0512**

V4A	316	Gebürstet		
	<b>OUTDOOR</b>		<b>Ø</b>	<b>D</b>
	140512-048-12		48,3	105
V4A	316	Hochglanzpoliert		
	<b>OUTDOOR</b>			
SELL OUT	140512-048-10		48,3	105

Geländerbasis

**Gummieinlagen für MOD 6100**



2 Stück pro Glasklemme

**MOD 5061**

**Zubehör**

Für monolithisches Glas		<b>T</b>	
205061-12	12		2
Für laminiertes Glas			
205061-13	12,76		2
205061-17	16,76		2
205061-18	17,52		2



SELL OUT Nur solange der Vorrat reicht.

**Q-INFO**

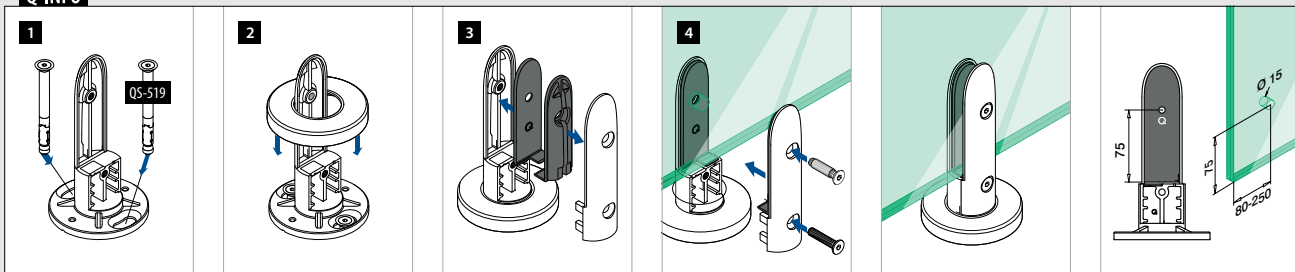

## Bodenglasklemmen - MOD 6200

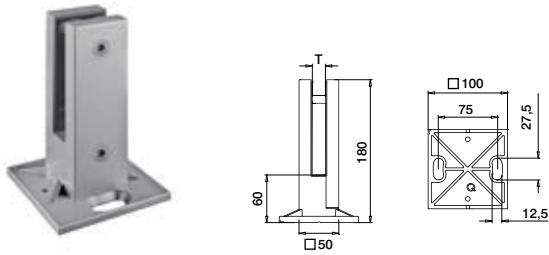

## MOD 6200

V4A	316	Gebürstet	T		
	<b>OUTDOOR</b>				
	146200-12		Siehe T in MOD 5062	459 - 465	1
V4A	316	Hochglanzpoliert			
	<b>OUTDOOR</b>				
<b>SELL OUT</b>	146200-10		Siehe T in MOD 5062	459 - 465	1
V4A	316	Black Line			
	<b>OUTDOOR</b>				
<b>NEW</b>	146200-82		Siehe T in MOD 5062	459 - 465	1



## Abdeckkappen für MOD 6200



## MOD 4562

V4A	316	Gebürstet		
	<b>OUTDOOR</b>			
	144562-12			2
V4A	316	Hochglanzpoliert		
	<b>OUTDOOR</b>			
<b>SELL OUT</b>	144562-10			2
V4A	316	Black Line		
	<b>OUTDOOR</b>			
<b>NEW</b>	144562-82			2

## Gummieinlagen für MOD 6200



2 Stück pro Glasklemme

## MOD 5062

## Zubehör

Für monolithisches Glas	T	
205062-12	12	2
205062-15	15	2
Für laminiertes Glas		
205062-13	12,76	2
205062-14	13,52	2
205062-17	16,76	2
205062-18	17,52	2

## Q-INFO 316

10

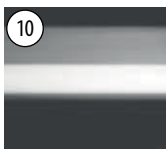
Hochglanz-  
poliert

12

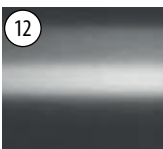

Gebürstet

82 RAL 9005

Schwarz, matt,  
strukturiert

## Q-INFO

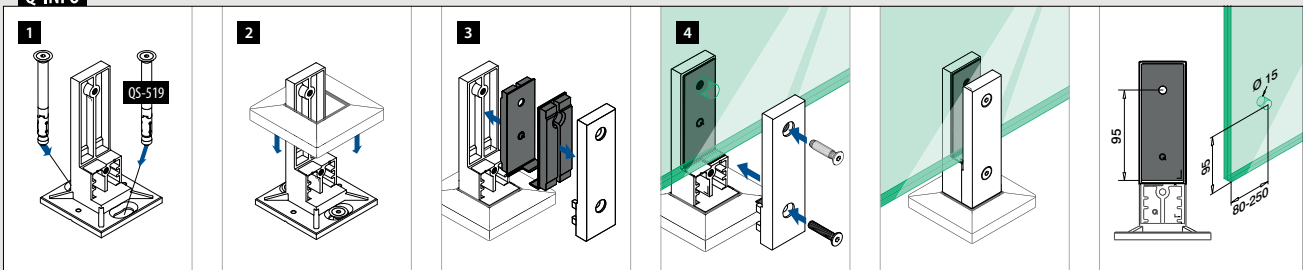





**Beanspruchung:** Leicht und mittel  
**Verwendung:** Innen- und Außenbereich  
**Montage:** Bodenmontage  
**Anwendung:** Balkone, Galerien, Wege und Abtrennungen  
**Material:** Edelstahl V4A (glasperlengestrahlt und gebürstet)  
**Glasstärke:** 15 bis 21,52 mm

Finden Sie alle Informationen zu Easy Glass Air online:



<https://q-ne.ws/Air23>

# EASY GLASS® AIR

# Machen Sie den Unterschied

Mit Easy Glass® Air verleihen Sie jedem Haus oder Gewerbeobjekt einen architektonischen Wow-Faktor! Das Glasgelenk verfügt über eine ultramoderne Bodenglasklemme mit einem markanten Aussehen. Das leichte und luftige Design der glasperlengestrahlt Klemme und des Verbinders erweckt den Eindruck, dass die Glaselemente schweben. Das Ergebnis ist pure Eleganz und maximale Transparenz.

Easy Glass® Air	DE
Max. Holmlast (kN/m)	0,5
Max. Glasbreite (Meter)	1,35



Bitte beachten Sie die Spezifikationen wie Befestigungs- und Glasmaße sowie Glastypen der jeweiligen Zertifikate.

### International getestet/berechnet/zertifiziert:



- 1 Air bietet ein harmonisch aufeinander abgestimmtes Design für Bodenglasklemme und Glasverbinder, was es zu einem einzigartigen System auf dem Markt macht.
- 2 Die Klemme lässt sich für Wandanschlüsse zweiteilen; passende Endkappen sind erhältlich.

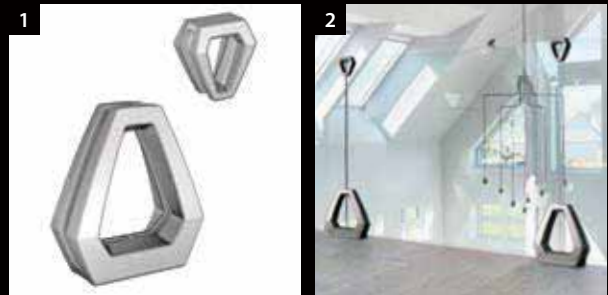

## EASY GLASS® AIR DESIGNOPTIONEN

**Air**  
Bodenglasklemme

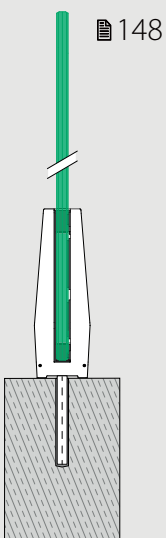

**Air**  
Bodenglasklemme mit Glasverbinder

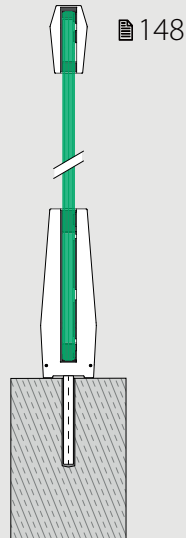

**Air**  
Bodenglasklemme mit Glasverbinder, Handlaufadapter und Handlauf

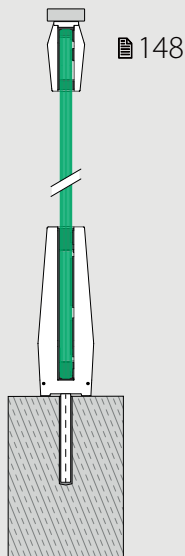

**Air**  
Bodenglasklemme mit Glasleistenrohr, U-Profil oder Kantenschutz

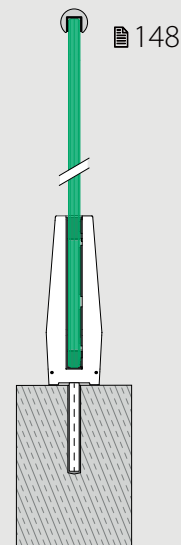

Geländerbasis

Bodenglasklemmen

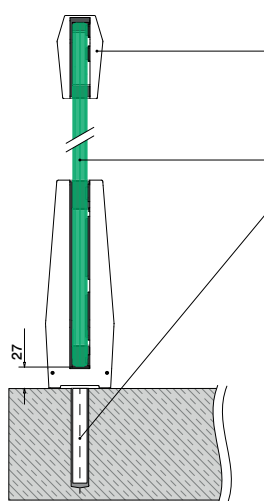

Glasleistenrohre: ■ 169 - 185  
 Glasverbinder MOD 6510: ■ 148  
 Kantenschutz: ■ 166 - 168  
 Handlauf 60x20: ■ 149

VSG aus ESG: ■ 160 - 161

Anker: ■ 459 - 465

Bitte beachten Sie die Spezifikationen wie Befestigungs- und Glasmaße sowie Glastypen der jeweiligen Zertifikate und statischen Berechnungen.

Geländerbasis

Bodenglasklemmen

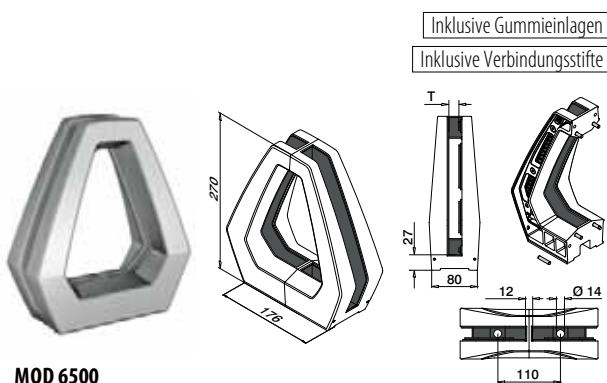

Inklusive Gummieinlagen

Inklusive Verbindungsstifte

MOD 6500

V4A	316	Gebürstet + glasperlengestrahlt	
	OUTDOOR	T	■
146500-12	15 - 21,52	■ 459 - 465	1



STATISCHE BERECHNUNG nach DIN 18008



AbP BALLAST-VERBODEN

Internationaler Geschmacksmusterschutz

Handläufe

Glasverbinder

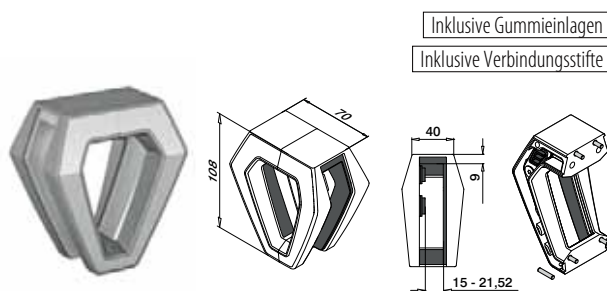

Inklusive Gummieinlagen

Inklusive Verbindungsstifte

MOD 6510

V4A	316	Gebürstet + glasperlengestrahlt	
	OUTDOOR		■
146510-12			1



Internationaler Geschmacksmusterschutz

Geländerbasis

Endkappen für Bodenglasklemmen

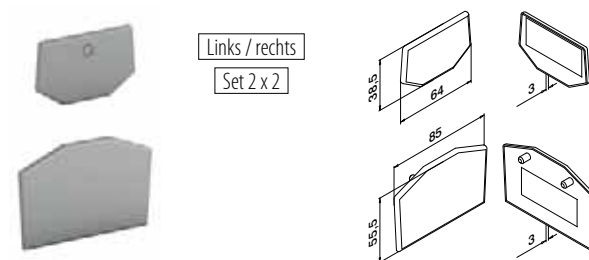

Links / rechts

Set 2 x 2

MOD 6502

V4A	316	Glasperlengestrahlt	
	OUTDOOR		■
146502-02			Set

Internationaler Geschmacksmusterschutz

Handläufe

Endkappen für Glasverbinder

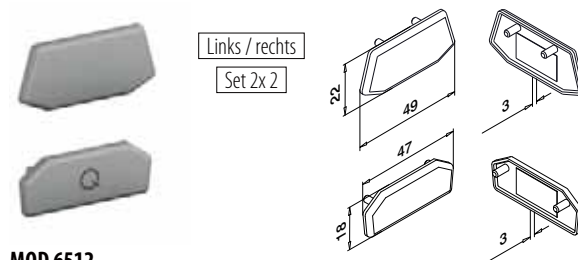

Links / rechts

Set 2 x 2

MOD 6512

V4A	316	Glasperlengestrahlt	
	OUTDOOR		■
146512-01			Set

Internationaler Geschmacksmusterschutz

Handläufe  
Handlaufadapter

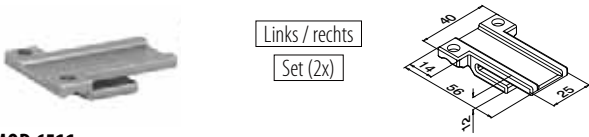

Links / rechts  
Set (2x)

MOD 6511

V4A	316	Glasperlengestrahlt		
	<b>OUTDOOR</b>	T		
146511-02	15 - 21,52	QS-13	472	Set



Internationaler Geschmacksusterschutz

Handläufe  
Endkappen



MOD 5728 - EASY HIT®

V4A	316	Gebürstet		
	<b>OUTDOOR</b>	Für		
145728-062-12	60 x 20 x 2,0			2



Internationaler Geschmacksusterschutz

Handläufe  
Rohre

Q-TUBE

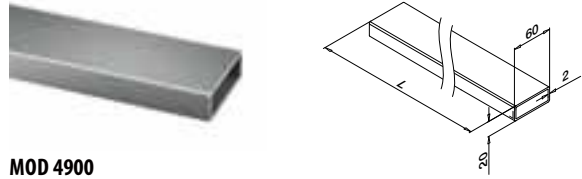

MOD 4900

V4A	316	Gebürstet		
	<b>OUTDOOR</b>			
144900-062-25-12	60 x 20 x 2,0			L = 2,5 m
144900-062-50-12	60 x 20 x 2,0			L = 5 m



Internationaler Geschmacksusterschutz

Handläufe  
Wandflansche

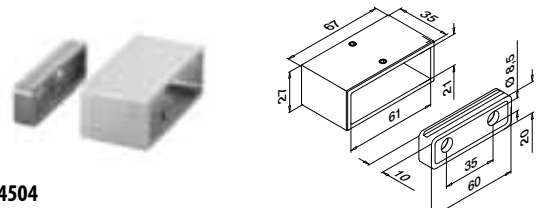

MOD 4504

V4A	316	Gebürstet		
	<b>OUTDOOR</b>	Für		
144504-062-12	60 x 20 x 2,0	QS-55	470 / QS-27	472
				2



Internationaler Geschmacksusterschutz

Q-INFO MOD 4900

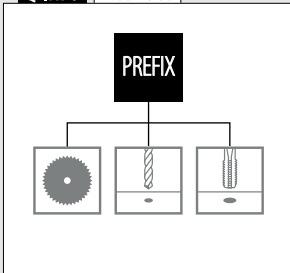

Q-INFO MOD 4504

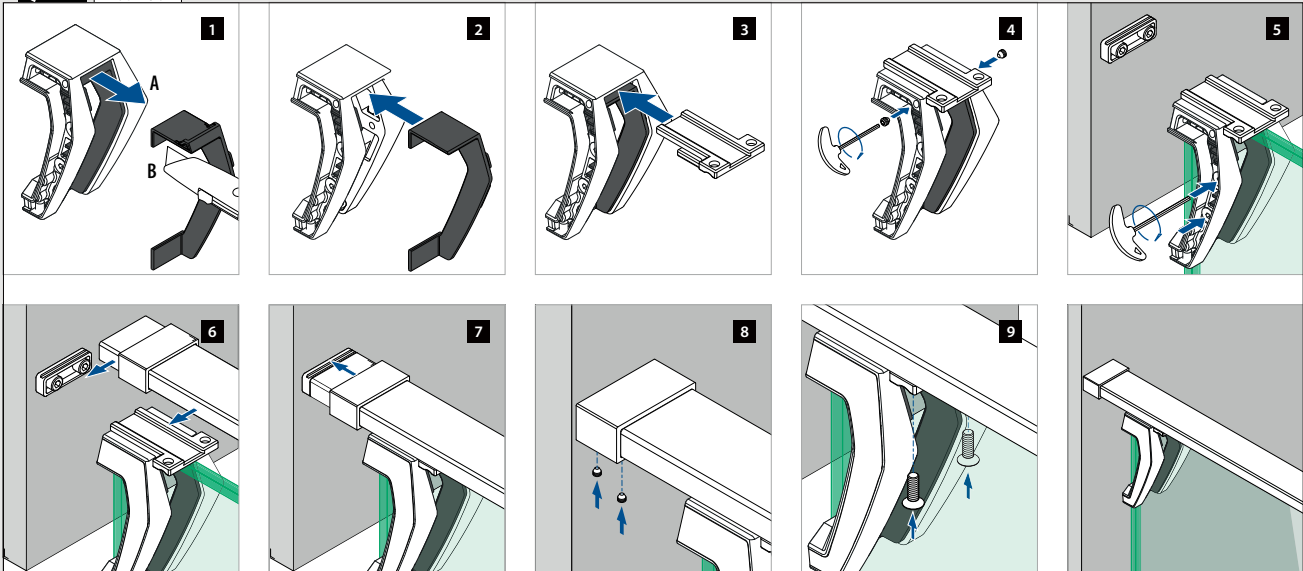





**Beanspruchung:** Leicht  
**Verwendung:** Innen- und Außenbereich  
**Montage:** Boden-, In-Boden- und Seitenmontage  
**Anwendung:** Balkone, Galerien, Wege, Abtrennungen, Treppen und französische Balkone  
**Material:** Edelstahl (gebürstet, hochglanzpoliert oder pulverbeschichtet RAL 9005 schwarz), Zinkdruckguss (roh oder Edelstahleffekt)  
**Glasstärke:** 12 bis 21,52 mm

Finden Sie alle Informationen zu Easy Glass Glasadapter online:



<https://q-ne.ws/GlassAdapters23>

EASY GLASS®

# GLAS- ADAPTER

WENIGER IST MEHR

MOD  
0745-0748

154 - 155

- Unterschiedliche Durchmesser und Wandabstände

## MOD 4747

158

- Unterschiedliche Glasdicken

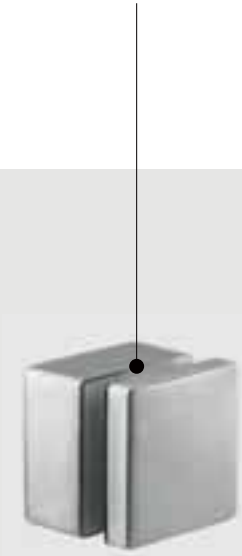

## MOD 0760-0766

156

- Installation mittels eines einzigen Ankers
- Einstellbarer Winkel bei MOD 0766
- MOD 0760 und 0762 besitzen eine integrierte Wasserwaage

## MOD 4762

158

- Installation mittels eines einzigen Ankers (optional: zusätzliche zweite Verankerung)
- Integrierte Wasserwaage



## MOD 0749

152

- Glasjustierung während der gesamten Installation möglich



### MOD 0749

DE

Max. Holmlast  
(kN/m)

1,0

STATISCHE  
BERECH-  
NUNG  
DIN18008

AbZ  
BALIART  
GEPÜFT

Bitte beachten Sie die Spezifikationen wie Befestigungs- und Glasmaße sowie Glastypeen der jeweiligen Zertifikate. Für weitere Informationen besuchen Sie [www.q-railing.com/zertifikate](http://www.q-railing.com/zertifikate)



## MOD 0763

159

- Installation mittels eines einzigen Ankers (optional: zusätzliche zweite Verankerung)
- Glasklemme und Adapter in einem (dank verstellbarem Glasstift)

### MOD 0763

DE

Max. Holmlast  
(kN/m)

0,5

STATISCHE  
BERECH-  
NUNG  
DIN18008

AbZ  
BALIART  
GEPÜFT

Bitte beachten Sie die Spezifikationen wie Befestigungs- und Glasmaße sowie Glastypeen der jeweiligen Zertifikate. Für weitere Informationen besuchen Sie [www.q-railing.com/zertifikate](http://www.q-railing.com/zertifikate)

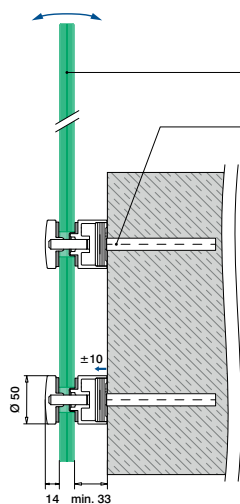

VSG aus ESG: 160 - 161

Anker: 459 - 465

Bitte beachten Sie die Spezifikationen wie Befestigungs- und Glasmaße sowie Glastypen der jeweiligen Zertifikate und statischen Berechnungen.

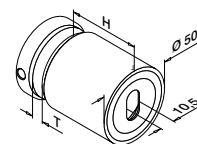

**MOD 0749**

V2A	304	Gebürstet		
INDOOR		H	T	
	130749-030-12	30	12 - 25,52	459 - 465 2
	130749-040-12	40	8 - 25,52	459 - 465 2
	130749-050-12	50	8 - 25,52	459 - 465 2

V2A	304	Black Line		
INDOOR		H	T	
NEW	130749-030-82	30	12 - 25,52	459 - 465 2
NEW	130749-040-82	40	8 - 25,52	459 - 465 2
NEW	130749-050-82	50	8 - 25,52	459 - 465 2

V4A	316	Gebürstet		
OUTDOOR		H	T	
	140749-030-12	30	12 - 25,52	459 - 465 2
	140749-040-12	40	8 - 25,52	459 - 465 2
	140749-050-12	50	8 - 25,52	459 - 465 2
	140749-100-12	100	8 - 25,52	459 - 465 2

V4A	316	Black Line		
OUTDOOR		H	T	
NEW	140749-030-82	30	12 - 25,52	459 - 465 2
NEW	140749-040-82	40	8 - 25,52	459 - 465 2
NEW	140749-050-82	50	8 - 25,52	459 - 465 2

V4A	316	Hochglanzpoliert		
OUTDOOR		H	T	
	140749-050-10	50	8 - 25,52	459 - 465 2

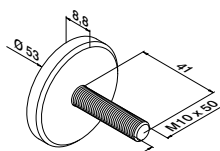

**MOD 0741**

V4A	316	Roh		
OUTDOOR		H	T	
	140741-150			2



**Q-INFO** 316 304

<p>10</p> <p>Hochglanzpoliert</p>	<p>12</p> <p>Gebürstet</p>	<p>82 RAL 9005</p> <p>Pulverbeschichtet Schwarz, matt, strukturiert</p>
-----------------------------------	----------------------------	---

**Q-INFO** MOD 0749

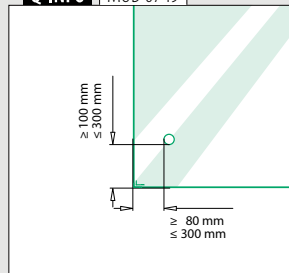

**Q-INFO** MOD 0741

**MOD 5030** 477

Zusätzliche Gummieinlagen für Glasadapter

**Q-INFO** MOD 0749

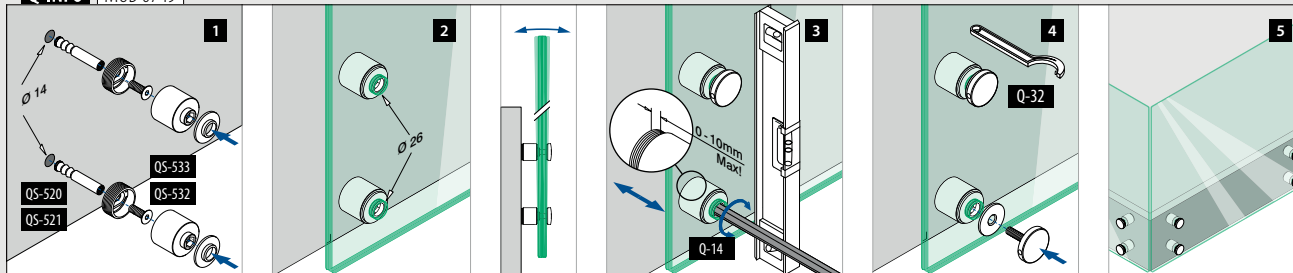

**Q-INFO** MOD 0741 / 0749

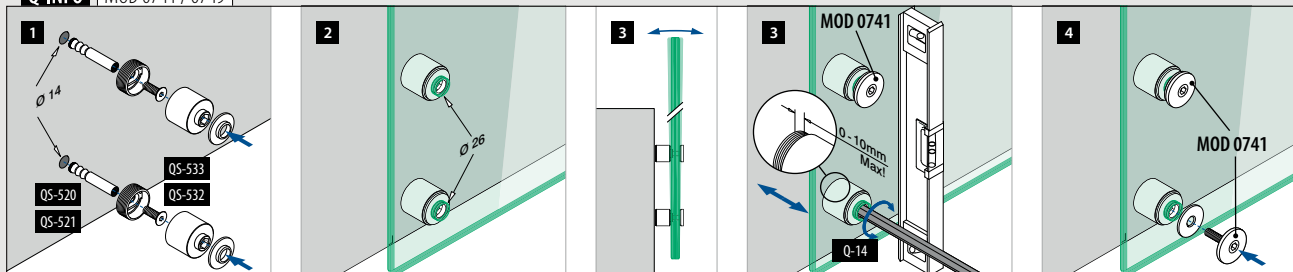





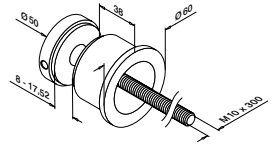
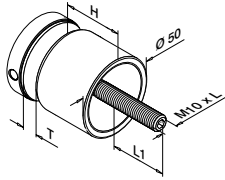

**MOD 0747**

V2A	304	Gebürstet				
INDOOR			H	T	L	L1
	130747-010-12		10	8 - 17,52	50	11 - 20
	130747-020-12		20	8 - 25,52	70	13 - 31
	130747-030-12		30	8 - 25,52	80	13 - 31
	130747-040-12		40	8 - 17,52	80	11 - 22
	130747-050-12		50	8 - 17,52	90	11 - 22

V2A	304	Black Line				
INDOOR						
NEW	130747-010-82		10	8 - 17,52	50	11 - 20
NEW	130747-030-82		30	8 - 25,52	80	13 - 31

V4A	316	Gebürstet				
OUTDOOR						
	140747-010-12		10	8 - 17,52	50	11 - 20
	140747-020-12		20	8 - 25,52	70	13 - 31
	140747-030-12		30	8 - 25,52	80	13 - 31
	140747-040-12		40	8 - 17,52	80	11 - 21
	140747-050-12		50	8 - 17,52	90	11 - 21

V4A	316	Black Line				
OUTDOOR						
NEW	140747-010-82		10	8 - 17,52	50	11 - 20
NEW	140747-030-82		30	8 - 25,52	80	13 - 31

V4A	316	Hochglanzpoliert				
OUTDOOR						
	140747-030-10		30	8 - 25,52	80	13 - 31

Zinkdruckguss		Roh				
INDOOR						
SELL OUT	100747-00		10	8 - 17,52	50	11 - 20

Zinkdruckguss		Edelstahleffekt				
OUTDOOR						
SELL OUT	100747-20		10	8 - 17,52	50	11 - 20



SELL OUT Nur solange der Vorrat reicht.

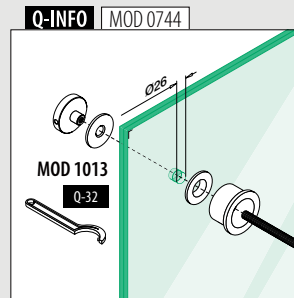
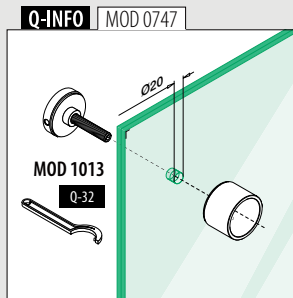
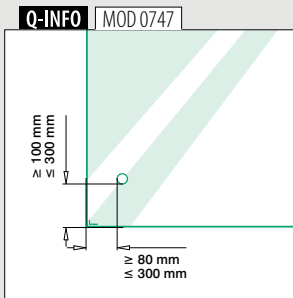

Q-INFO	304	316
10	12	82 RAL 9005
Hochglanzpoliert	Gebürstet	Pulverbeschichtet
		Schwarz, matt, strukturiert

Q-INFO	Zinkdruckguss
00	20
Roh	Edelstahleffekt

Q-INFO
<b>MOD 1013</b> 485
Hakenschlüssel

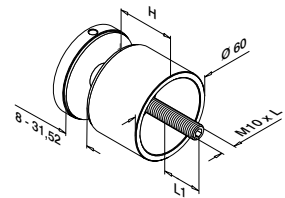
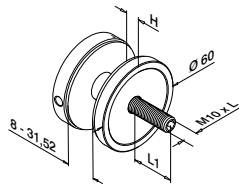

## MOD 0745

V2A	304	Gebürstet			
INDOOR		H	L	L1	
130745-010-12		10	70	17 - 41	2

V4A	316	Gebürstet			
OUTDOOR		H	L	L1	
140745-010-12		10	70	17 - 41	2

V4A	316	Hochglanzpoliert			
OUTDOOR		H	L	L1	
140745-010-10		10	70	17 - 41	2



## MOD 0745

V2A	304	Gebürstet			
INDOOR		H	L	L1	
130745-030-12		30	90	17 - 41	2
130745-050-12		50	110	17 - 41	2

V4A	316	Gebürstet			
OUTDOOR		H	L	L1	
140745-030-12		30	90	17 - 41	2
140745-050-12		50	110	17 - 41	2

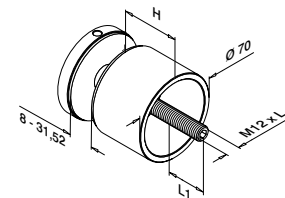
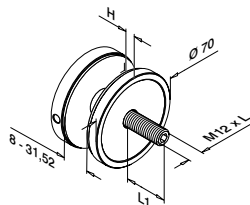

## MOD 0748

V2A	304	Gebürstet			
INDOOR		H	L	L1	
130748-010-12		10	70	17 - 41	2

V4A	316	Gebürstet			
OUTDOOR		H	L	L1	
140748-010-12		10	70	17 - 41	2

V4A	316	Hochglanzpoliert			
OUTDOOR		H	L	L1	
140748-010-10		10	70	17 - 41	2



## MOD 0748

V2A	304	Gebürstet			
INDOOR		H	L	L1	
130748-030-12		30	90	17 - 41	2
130748-040-12		40	100	17 - 41	2

V2A	304	Hochglanzpoliert			
INDOOR		H	L	L1	
130748-050-10		50	110	17 - 41	2

V4A	316	Gebürstet			
OUTDOOR		H	L	L1	
140748-030-12		30	90	17 - 41	2
140748-040-12		40	100	17 - 41	2



## Q-INFO

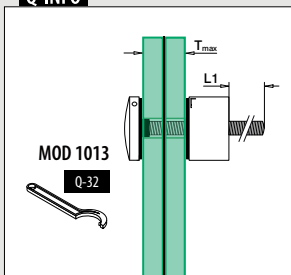

## Q-INFO | MOD 0745-010

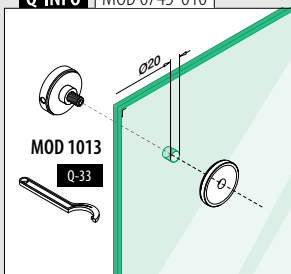

## Q-INFO | MOD 0745-030 / 050

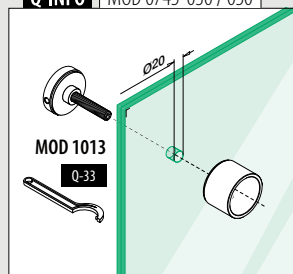

## Q-INFO | MOD 0748-010

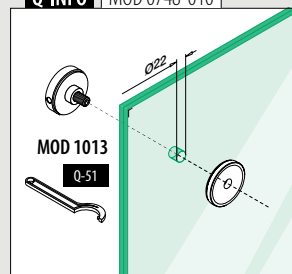

## Q-INFO | MOD 0748-030 / 040 / 050

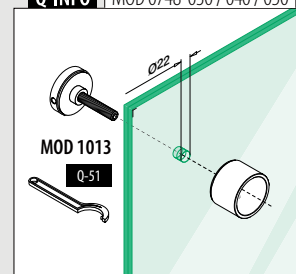

Geländerbasis

Blockförmige Glasadapter

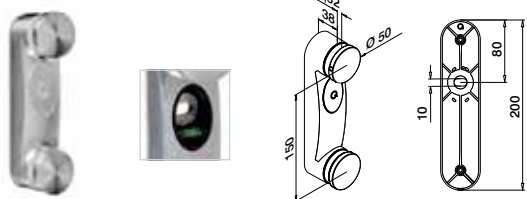

MOD 0762

V2A	304	Gebürstet		
<b>INDOOR</b>				
130762-12			459 - 465	1

V4A	316	Gebürstet		
<b>OUTDOOR</b>				
140762-12			459 - 465	1



Internationaler Geschmacksmusterschutz

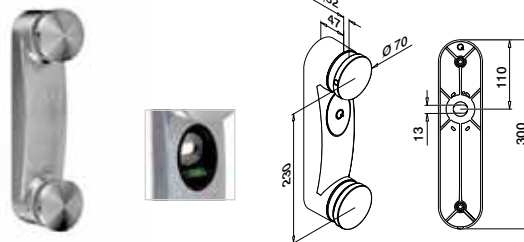

MOD 0760

V2A	304	Gebürstet		
<b>INDOOR</b>				
130760			459 - 465	1

SELL OUT



Internationaler Geschmacksmusterschutz

Geländerbasis

Blockförmige Glasadapter

Neigung einstellbar

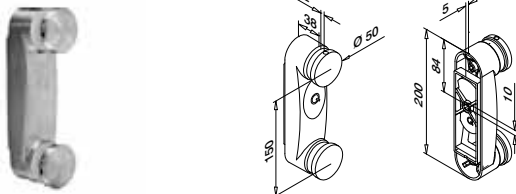

MOD 0766

V2A	304	Gebürstet		
<b>INDOOR</b>				
130766			459 - 465	1



Internationaler Geschmacksmusterschutz

Q-INFO MOD 0766

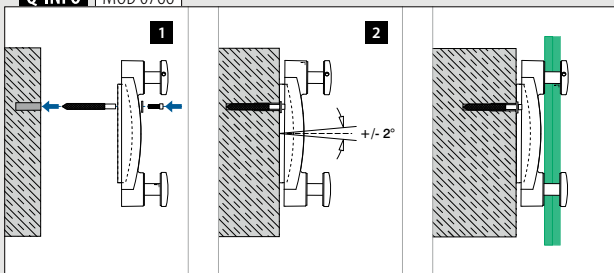

Q-INFO MOD 0762 / 0760

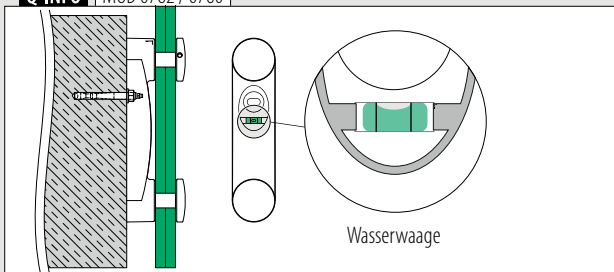

SELL OUT

Nur solange der Vorrat reicht.

Q-INFO MOD 0762 / 0766

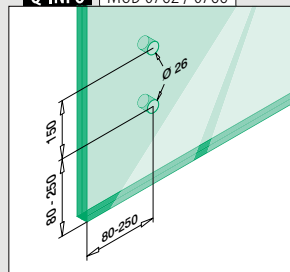

Q-INFO MOD 0760

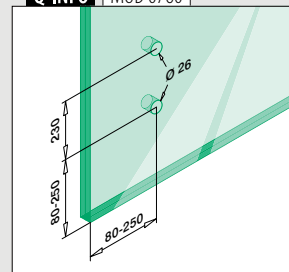





MOD 0760

Q-railing



Geländerbasis

Punktförmige Glasadapter

Quadratisch

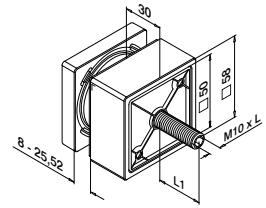
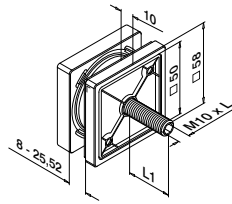

MOD 4747

V4A	316	Gebürstet		
	OUTDOOR	L	L1	
	144747-010-12	60	13 - 31	2



Internationaler Geschmacksmusterschutz

MOD 4747

V4A	316	Gebürstet		
	OUTDOOR	L	L1	
	144747-030-12	80	13 - 31	2

V4A	316	Hochglanzpoliert		
	OUTDOOR	L	L1	
SELL OUT	144747-030-10	80	13 - 31	2



Internationaler Geschmacksmusterschutz

Geländerbasis

Blockförmige Glasadapter

Rechteckig

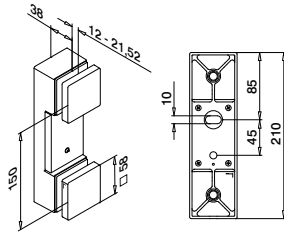

MOD 4762

V4A	316	Gebürstet		
	OUTDOOR			
	144762-12	459 - 465		1



Internationaler Geschmacksmusterschutz

Q-INFO 316

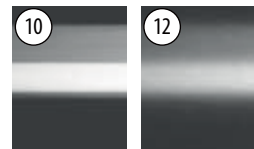

Hochglanzpoliert

Gebürstet



Nur solange der Vorrat reicht.

Q-INFO MOD 4762

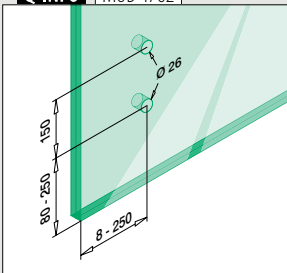

Q-INFO MOD 4747

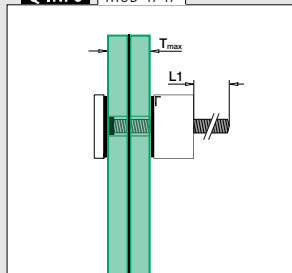

Q-INFO MOD 4747

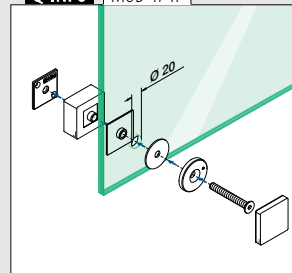

Q-INFO MOD 4747

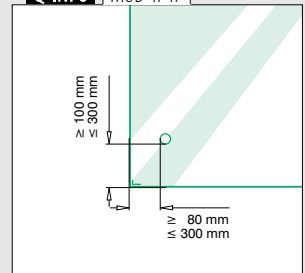

Q-INFO MOD 4762

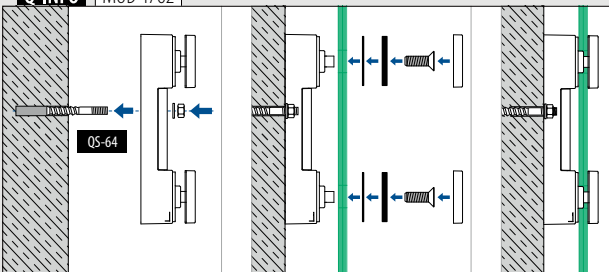

Q-INFO MOD 4762

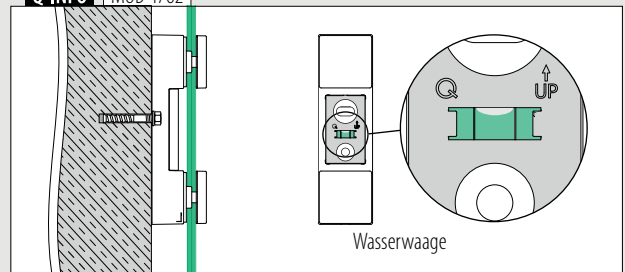

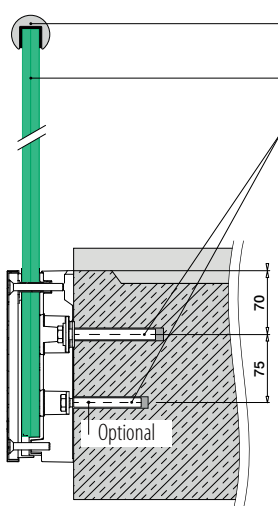

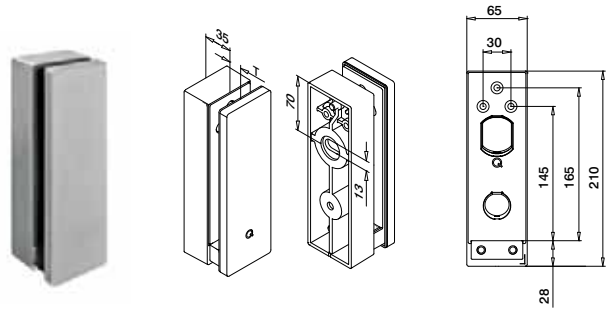

Glasleistenrohre: ■ 169 - 185  
 Kantenschutz: ■ 166 - 168  
 VSG aus ESG: ■ 160 - 161  
 Anker: ■ 459 - 465

Bitte beachten Sie die Spezifikationen wie Befestigungs- und Glasmaße sowie Glastypen der jeweiligen Zertifikate und statischen Berechnungen.



**MOD 0763**

V2A	304	Gebürstet		
<b>INDOOR</b>		<b>T</b>		
130763-12		12 - 21,52	■ 459 - 465	1
V4A	316	Gebürstet		
<b>OUTDOOR</b>				
140763-12		12 - 21,52	■ 459 - 465	1



Internationaler Geschmacksmusterschutz

**Q-INFO**

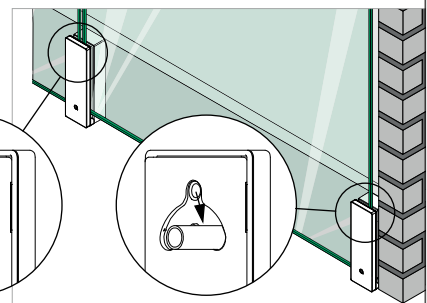
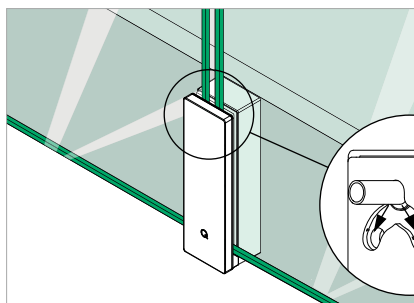
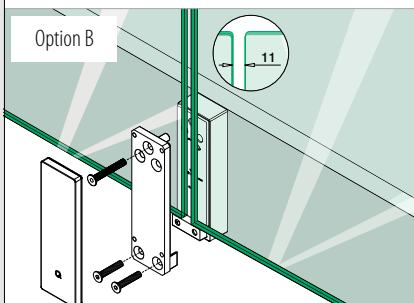
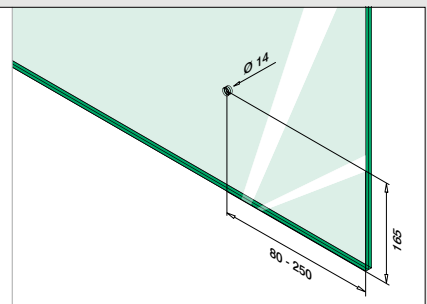
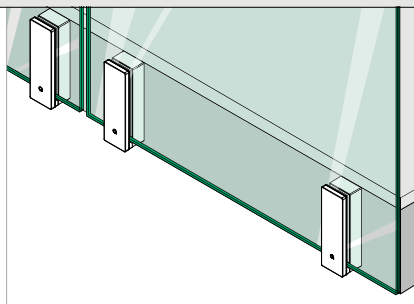
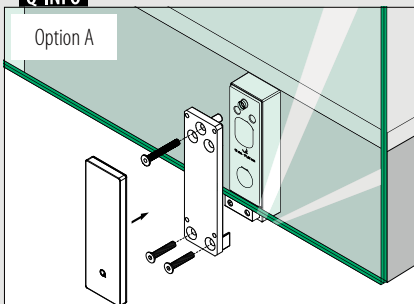



Q-GLASS

# GLASSCHEIBEN FÜR GANZGLAS- GELÄNDERSYSTEME

Bestellen Sie die Glaselemente zeitgleich mit allen anderen Produkten für ihr Ganzglasgeländer

## Maßgefertigtes Glas

- Von monolithisches Glas bis hin zu 31,52 mm Verbundsicherheitsglas
- Optional mit matter, farbiger oder SentryGlas®-Folie
- Abgerundete Ecken und polierte Kanten auf Anfrage
- Optional mit vorgebohrten Löchern
- Gebogenes Glas

## Glas in der Standardausführung

- Sofort ab Lager verfügbar
- Verbundsicherheitsglas
- 8,76 - 16,76 mm stark  
(10 verschiedene Glasbreiten und 3 -höhen)
- Geschliffene, gesäumte und polierte Kanten
- Abgerundete Ecken

■ CE-Kennzeichnung ■ Hohe Qualität ■ Schnelle Lieferung ■ All-inclusive-Preise ■ Einfache Bestellung

Q-GLASS (Verbund-)Sicherheitsglas

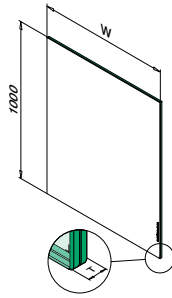

MOD 5017

(Verbund-)Sicherheitsglas ESG/VSG

SELL OUT	OUTDOOR	W	T
SELL OUT	195017-040-10	400	16,76
SELL OUT	195017-050-10	500	16,76
SELL OUT	195017-060-10	600	16,76
SELL OUT	195017-070-10	700	16,76
	195017-080-10	800	16,76
	195017-090-10	900	16,76
	195017-095-10	950	16,76
	195017-100-10	1000	16,76
	195017-100-11	1100	16,76
	195017-100-12	1200	16,76

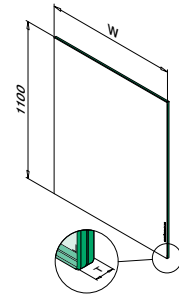

MOD 5017

(Verbund-)Sicherheitsglas ESG/VSG

SELL OUT	OUTDOOR	W	T
SELL OUT	195017-040-11	400	16,76
SELL OUT	195017-050-11	500	16,76
SELL OUT	195017-060-11	600	16,76
SELL OUT	195017-070-11	700	16,76
	195017-080-11	800	16,76
	195017-090-11	900	16,76
	195017-095-11	950	16,76
	195017-100-11	1000	16,76

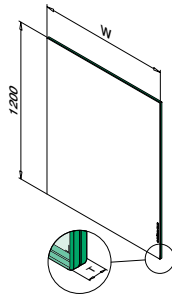

MOD 5017

(Verbund-)Sicherheitsglas ESG/VSG

SELL OUT	OUTDOOR	W	T
SELL OUT	195017-040-12	400	16,76
SELL OUT	195017-050-12	500	16,76
SELL OUT	195017-060-12	600	16,76
	195017-070-12	700	16,76
	195017-080-12	800	16,76
	195017-090-12	900	16,76
	195017-095-12	950	16,76
	195017-100-12	1000	16,76



Q-glass ist direkt ab Lager lieferbar.

SELL OUT Nur solange der Vorrat reicht.

Q-INFO

Berechnung

$$H \text{ (m)} \times W \text{ (m)} \times 2,5 \times T_g \text{ (mm)} = \text{kg}$$

Beispiel

H	W	T
1,1 m	1,0 m	16 mm
1,1 x 1,0 x 2,5 x 16 = 44,00 kg		

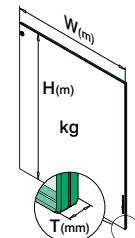

Q-INFO

(Verbund-)Sicherheitsglas

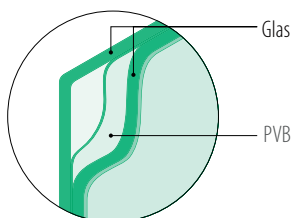
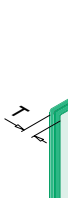

✓ Geschliffene Kanten



✓ Abgerundete Ecken



✓ Gesäumte Kanten



✓ Polierte Kanten



Füllungen

Glasverbinder

Ø 50

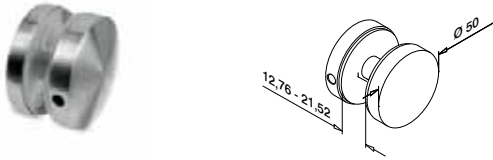

MOD 0742

V2A	304	Gebürstet	
<b>INDOOR</b>			
130742-12			2
V4A	316	Gebürstet	
<b>OUTDOOR</b>			
140742-12			2
V4A	316	Hochglanzpoliert	
<b>OUTDOOR</b>			
140742-10			2



Füllungen

Gummieinlagen für MOD 2870 / 2890



4 Stück pro Glasverbinder

MOD 5028

Zubehör		
Für laminiertes Glas	T	
205028-17	16,76	8
205028-18	17,52	8
205028-21	20,76	8
205028-22	21,52	8



MOD 2870, 2880, 2890  
Für T = 6 - 12,76 mm  
448

Füllungen

Glasverbinder - für Glasstärken 16,76 - 21,52 mm

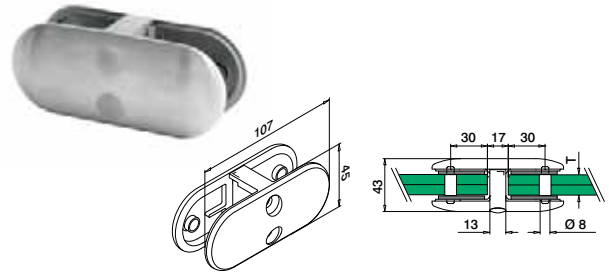

MOD 2870

V4A	316	Gebürstet	
<b>OUTDOOR</b>			
142870-22-12		Siehe T in MOD 5028	2



Internationaler Geschmacksmusterschutz



MOD 2890

V4A	316	Gebürstet	
<b>OUTDOOR</b>			
142890-22-12		Siehe T in MOD 5028	2



Internationaler Geschmacksmusterschutz

Zubehör

Sicherungsstifte

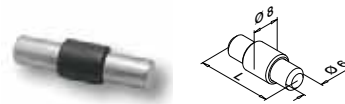

Optional verwendbar für MOD 2870 / 2890

MOD 5015

Zubehör		
	L	
205015-24	30	4

Q-INFO 316

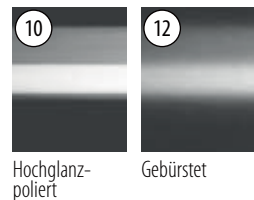

Q-INFO MOD 0742

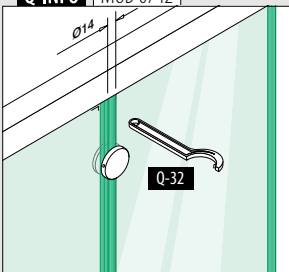

Q-INFO MOD 2870

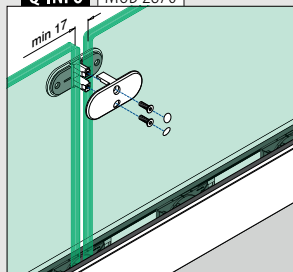

Q-INFO MOD 2890

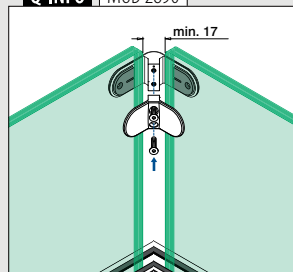

Q-INFO MOD 2870 / 2890

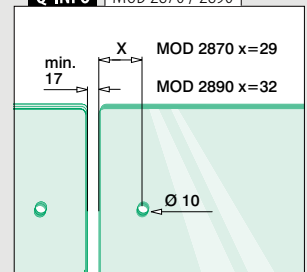

Glasverbinder - für Glasstärken 16,76 - 21,52 mm

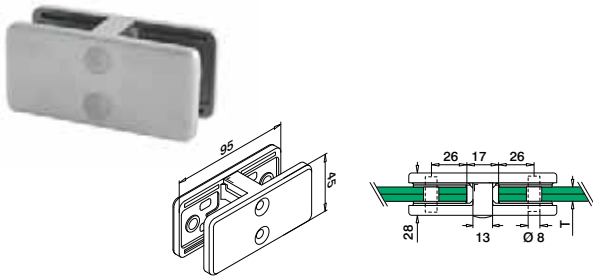

**MOD 4270**

V4A	316	Gebürstet		
	<b>OUTDOOR</b>		<b>T</b>	
144270-22-12			Siehe T in MOD 5042	2



Internationaler Geschmacksmusterschutz

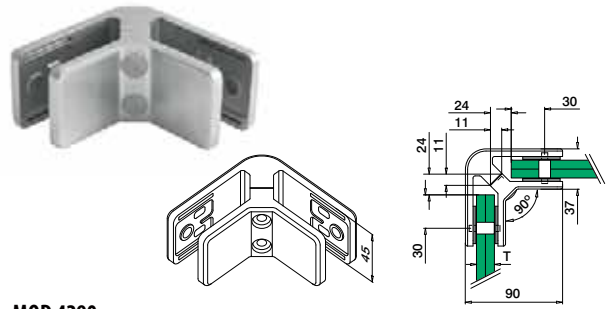

**MOD 4290**

V4A	316	Gebürstet		
	<b>OUTDOOR</b>		<b>T</b>	
144290-22-12			Siehe T in MOD 5042	2



Internationaler Geschmacksmusterschutz

Gummieinlagen für MOD 4270 / 4290



4 Stück pro Glasverbinder

**MOD 5042**

	<b>Zubehör</b>			
Für laminiertes Glas	<b>T</b>			
205042-17	16,76			8
205042-18	17,52			8
205042-21	20,76			8
205042-22	21,52			8

Sicherungsstifte

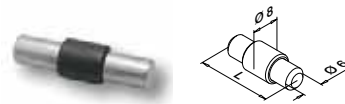

Optional verwendbar für MOD 4270 / 4290

**MOD 5015**

	<b>Zubehör</b>			
	<b>L</b>			
205015-24	30			4



**MOD 4270, 4280, 4290**  
Für T = 6 - 12,76 mm  
 449

**Q-INFO** MOD 4270

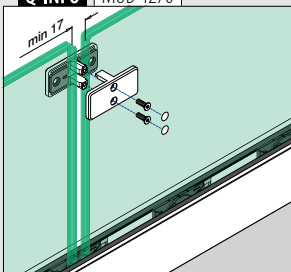

**Q-INFO** MOD 4290

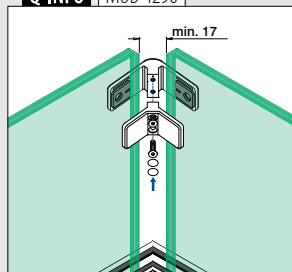

**Q-INFO** MOD 4270 / 4290

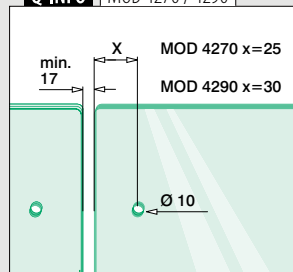

Zubehör

Glasverbinder

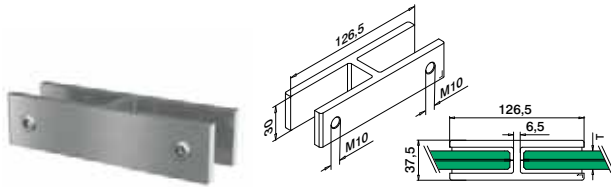

MOD 0291

<b>Aluminium</b>	Gebürstet		
<b>OUTDOOR</b>		<b>T</b>	
160291-22-18	Siehe T in MOD 5092		2

NEW

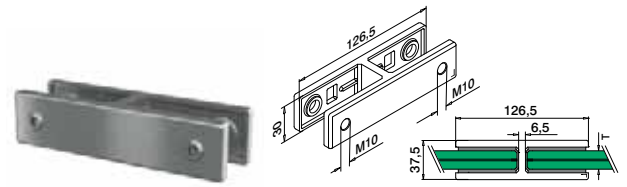

MOD 0291

<b>V4A 316</b>	Gebürstet		
<b>OUTDOOR</b>		<b>T</b>	
140291-22-12	Siehe T in MOD 5091		2

NEW

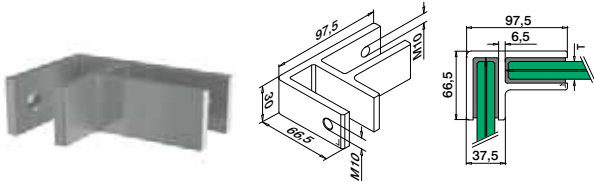

MOD 0292

<b>Aluminium</b>	Gebürstet		
<b>OUTDOOR</b>		<b>T</b>	
160292-22-18	Siehe T in MOD 5092		2

NEW

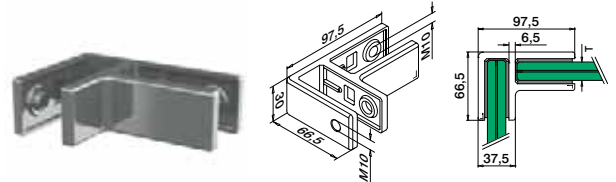

MOD 0292

<b>V4A 316</b>	Gebürstet		
<b>OUTDOOR</b>		<b>T</b>	
140292-22-12	Siehe T in MOD 5091		2

NEW

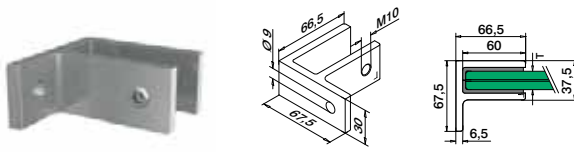

MOD 0293

<b>Aluminium</b>	Gebürstet		
<b>OUTDOOR</b>		<b>T</b>	
160293-22-18	Siehe T in MOD 5092		2

NEW

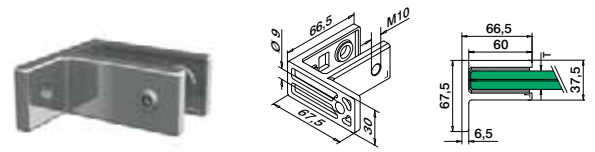

MOD 0293

<b>V4A 316</b>	Gebürstet		
<b>OUTDOOR</b>		<b>T</b>	
140293-22-12	Siehe T in MOD 5091		2

NEW

Füllungen

Gummieinlagen für MOD 0291 / 0292 / 0293 (Aluminium)



4 Stück für MOD 0291 und 0292  
2 Stück MOD 0293  
Inklusive Glasbefestigungsschrauben

MOD 5092

<b>Zubehör</b>			
Für laminiertes Glas	<b>T</b>		
205092-18	16,76 + 17,52		4
205092-22	20,76 + 21,52		4

NEW

Füllungen

Gummieinlagen für MOD 0291 / 0292 / 0293 (Edelstahl)



4 Stück für MOD 0291 und 0292  
2 Stück MOD 0293  
Inklusive Glasbefestigungsschrauben

MOD 5091

<b>Zubehör</b>			
Für laminiertes Glas	<b>T</b>		
205091-18	16,76 + 17,52		4
205091-22	20,76 + 21,52		4

NEW

Q-INFO MOD 0291

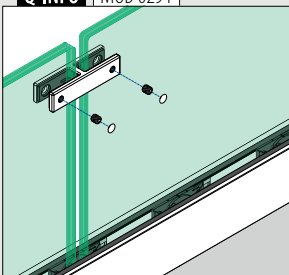

Q-INFO MOD 0292

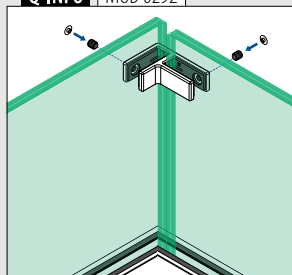

Q-INFO MOD 0293

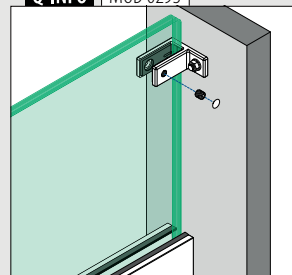



# KANTEN-SCHUTZ

166

# U-PROFILE

167, 168



# GLASLEISTEN-ROHRE quadratisch / rechteckig

176



# GLASLEISTEN-ROHRE rund

169



Q-railing



Kantenschutz

Kantenschutzprofile

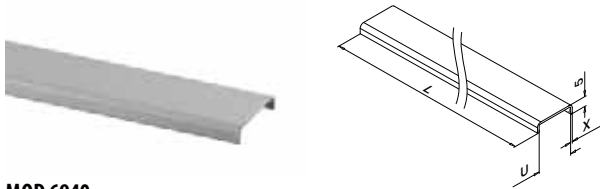

MOD 6940

Aluminium Roh	U	Q	X	T	Icon
166940-050-18-00	18,5	Q-98	1,5	16,76 - 17,52	L = 5 m
Aluminium Gebürstet					
OUTDOOR					
166940-025-18-18	18,5	Q-98	1,5	16,76 - 17,52	L = 2,5 m
166940-025-22-18	22,5	Q-99	1,5	20,76 - 21,52	L = 2,5 m
166940-050-18-18	18,5	Q-98	1,5	16,76 - 17,52	L = 5 m
166940-050-22-18	22,5	Q-99	1,5	20,76 - 21,52	L = 5 m
Aluminium Black Line					
OUTDOOR					
166940-025-18-82	18,5	Q-98	1,5	16,76 - 17,52	L = 2,5 m

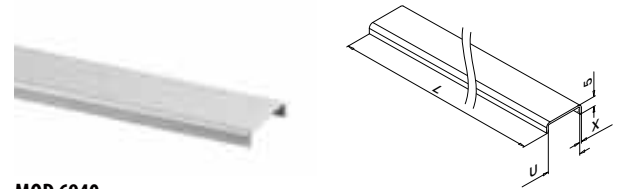

MOD 6940

V4A 316 Gebürstet	U	Q	X	T	Icon
OUTDOOR					
146940-025-18-12	18,5	Q-98	1	16,76 - 17,52	L = 2,5 m
146940-025-22-12	22,5	Q-99	1	20,76 - 21,52	L = 2,5 m
146940-050-14-12	14,5	Q-111	1	12,76 - 13,52	L = 5 m
146940-050-18-12	18,5	Q-98	1	16,76 - 17,52	L = 5 m
146940-050-22-12	22,5	Q-99	1	20,76 - 21,52	L = 5 m
146940-050-26-12	26,5	Q-112	1	24,76 - 25,52	L = 5 m

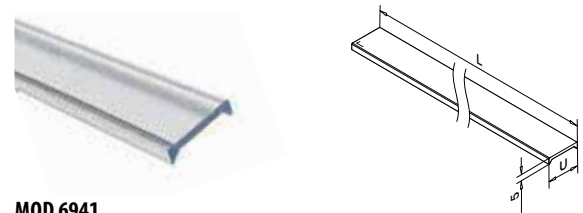

MOD 6941

Kunststoff Transparent	U	Q	T	Icon
INDOOR				
156941-025-18-03	18,5	Q-122	16,76 - 17,52	L = 2,5 m

NEW

Kantenschutz

Ecken

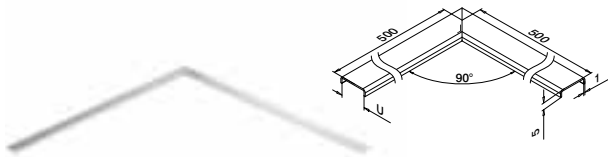

MOD 6340

V4A 316 Gebürstet	U	T	Icon
OUTDOOR			
146340-500-18	18,5	16,76 - 17,52	1
146340-500-22	22,5	20,76 - 21,52	1
146340-500-26	26,5	24,76 - 25,52	1



Q-INFO Aluminium MOD 6940

<b>00</b> Roh	<b>18</b> Gebürstet, anodisiert	<b>82 RAL 9005</b> Pulverbeschichtet Schwarz, matt, strukturiert
------------------	------------------------------------	--

Q-INFO

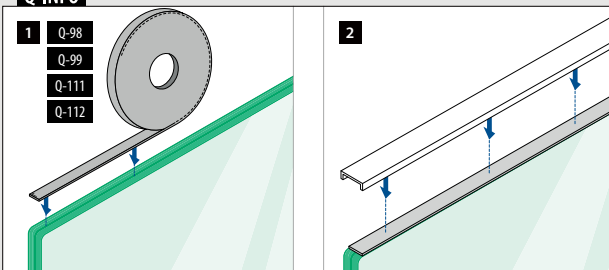

Q-INFO MOD 6940

PREFIX

Q-INFO 316 MOD 6340 / 6940

PREFIX

Q-INFO

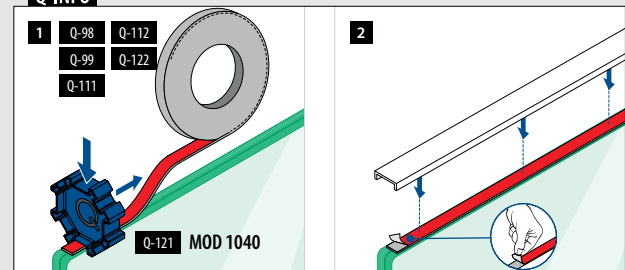

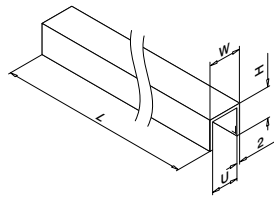

## MOD 6944

Aluminium Gebürstet

OUTDOOR	U	Q	T	W	H	
166944-050-13-18	13,25	Q-111	12,76	17,25	15	L = 5 m
166944-050-18-18	18	Q-98	16,76 - 17,52	22	20	L = 5 m
166944-050-22-18	22	Q-99	21,52	26	20	L = 5 m

Aluminium Black Line

OUTDOOR	U	Q	T	W	H	
166944-050-13-82	13,25	Q-111	12,76	17,25	15	L = 5 m
166944-050-18-82	18	Q-98	16,76 - 17,52	22	20	L = 5 m
166944-050-22-82	22	Q-99	21,52	26	20	L = 5 m

NEW

NEW

NEW

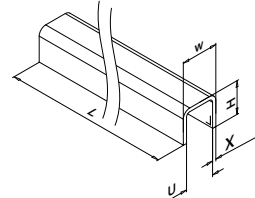

## MOD 6960

V2A 304 Gebürstet

INDOOR	U	X	T	W	H	
136960-050-24-12	24	3	8 - 21,52	30	27	L = 5 m

V4A 316 Gebürstet

OUTDOOR	U	X	T	W	H	
146960-050-24-12	24	3	8 - 21,52	30	27	L = 5 m
146960-050-34-12	34	3	8 - 31,52	40	37	L = 5 m

V4A 316 Black Line

OUTDOOR	U	X	T	W	H	
146960-050-24-82	24	3	8 - 21,52	30	27	L = 5 m

## MOD 6961

V2A 304 Gebürstet

INDOOR	U	X	T	W	H	
136961-050-24-12	24	2	8 - 21,52	28	26	L = 5 m

V4A 316 Gebürstet

OUTDOOR	U	X	T	W	H	
146961-050-24-12	24	2	8 - 21,52	28	26	L = 5 m
146961-050-34-12	34	2	8 - 31,52	38	36	L = 5 m



## Q-INFO MOD 6944

PREFIX



## Q-INFO Aluminium

18

82 RAL 9005

Pulver-  
beschichtetGebürstet,  
anodisiertSchwarz, matt,  
strukturiert

## Q-INFO MOD 6960 / 6961

PREFIX



\*MOD 6961

## Q-INFO 304 316

12

82 RAL 9005

Pulver-  
beschichtet

Gebürstet

Schwarz, matt,  
strukturiert

## Q-INFO

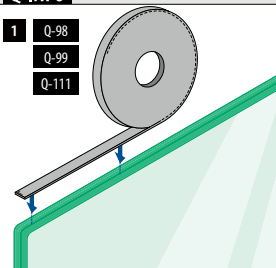
1 Q-98  
Q-99  
Q-111

2

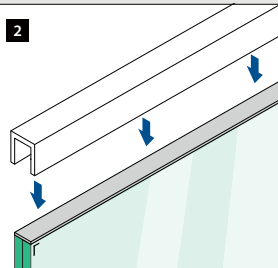

## Q-INFO MOD 6960 / 6961

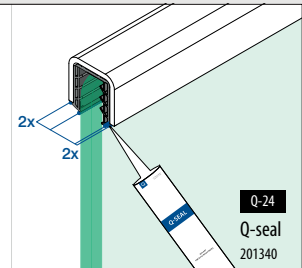
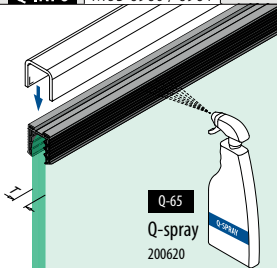

U-Profile

Ecken

Quadratisch



MOD 6362

V4A	316	Gebürstet	OUTDOOR	U	X	T	W	H		
				146362-24-12	24	3	8 - 21,52	30	27	1
				146362-34-12	34	3	8 - 31,52	40	37	1

V4A	316	Black Line	OUTDOOR	U	X	T	W	H		
NEW				146362-24-82	24	3	8 - 21,52	30	27	1

MOD 6361

V4A	316	Gebürstet	OUTDOOR	U	X	T	W	H		
				146361-24	24	2	8 - 21,52	28	26	1
				146361-34	34	2	8 - 31,52	38	36	1

U-Profile

Endkappen

Quadratisch

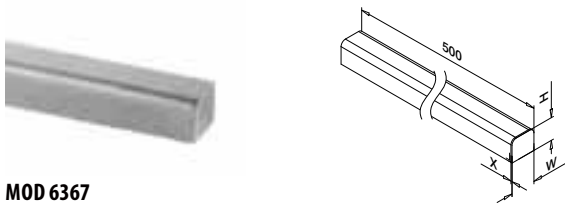

MOD 6367

V4A	316	Gebürstet	OUTDOOR	U	X	T	W	H		
				146367-24-12	24	3	8 - 21,52	30	27	1
				146367-34-12	34	3	8 - 31,52	40	37	1

V4A	316	Black Line	OUTDOOR	U	X	T	W	H		
NEW				146367-24-82	24	3	8 - 21,52	30	27	1

MOD 6366

V4A	316	Gebürstet	OUTDOOR	U	X	T	W	H		
				146366-24	24	2	8 - 21,52	28	26	1
				146366-34	34	2	8 - 31,52	38	36	1

U-Profile

Gummieinlagen



MOD 5124

Zubehör

U = 24 mm

Für monolithisches Glas	T	
205124-050-08	8 - 10	L = 5 m
205124-050-11	12	L = 5 m
205124-050-15	15	L = 5 m
205124-050-19	19	L = 5 m

Für laminiertes Glas

205124-050-08	8,76 - 10,76	L = 5 m
205124-050-11	11,52 - 13,52	L = 5 m
205124-050-17	16,76 - 17,52	L = 5 m
NEW 205124-050-92	20,76 - 21,52	L = 5 m

MOD 5134

Zubehör

U = 34 mm

Für monolithisches Glas	T	
205134-050-08	8 - 10	L = 5 m
205134-050-11	12	L = 5 m
205134-050-19	19	L = 5 m

Für laminiertes Glas

205134-050-08	8,76 - 10,76	L = 5 m
205134-050-11	11,52 - 13,52	L = 5 m
205134-050-17	16,76 - 17,52	L = 5 m
205134-050-22	20,76 - 21,52	L = 5 m
205134-050-24	24,76 - 25,52	L = 5 m
205134-050-32	31,52	L = 5 m

Q-INFO 304 316

12

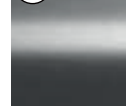

Gebürstet

82 RAL 9005



Schwarz, matt, strukturiert

Q-INFO MOD 6366 / 6367

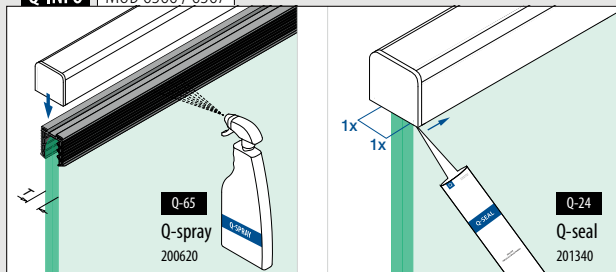

Q-INFO MOD 6361 / 6362

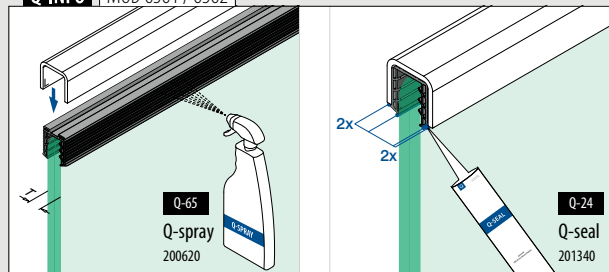

Glasleistenrohre

**Glasleistenrohre**

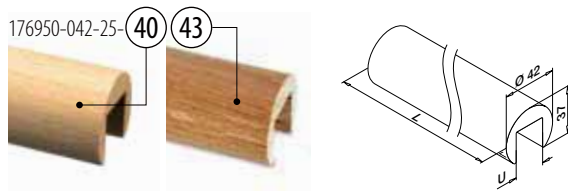

**MOD 6950**

<b>Buche</b>	Natur lackiert		
<b>INDOOR</b>	<b>U</b>		
176950-042-25-40	24		L = 2,5 m
<b>Eiche</b>	Natur lackiert		
<b>INDOOR</b>			
176950-042-25-43	24		L = 2,5 m

**PREFIX**

Glasleistenrohre

**Verbinder**



**MOD 6791**

<b>V2A</b>	<b>304</b>	Gebürstet		
<b>INDOOR</b>	<b>Ø</b>			
176791-042	42,0	QS-49  473		2



Glasleistenrohre

**Endkappen**



**MOD 6729**

<b>V2A</b>	<b>304</b>	Gebürstet		
<b>INDOOR</b>				
176729-042		QS-49  473		2



Holz ist ein Naturprodukt. Farbabweichungen sind möglich.

Glasleistenrohre

**Gummieinlagen**



**MOD 5124**

<b>Zubehör</b>		
<b>U = 24 mm</b>		
<b>Für monolithisches Glas</b>	<b>T</b>	
205124-050-08	8 - 10	L = 5 m
205124-050-11	12	L = 5 m
205124-050-15	15	L = 5 m
205124-050-19	19	L = 5 m

**Für laminiertes Glas**

205124-050-08	8,76 - 10,76	L = 5 m
205124-050-11	11,52 - 13,52	L = 5 m
205124-050-17	16,76 - 17,52	L = 5 m
<b>NEW</b> 205124-050-92	20,76 - 21,52	L = 5 m

Zubehör

**Bohrschablone**



**MOD 1024**

<b>Zubehör</b>	<b>Q</b>	
201024-042	Q-20	1

**Q-INFO** MOD 6950

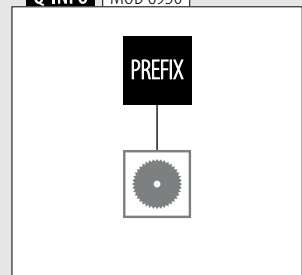

**Q-INFO** MOD 6950

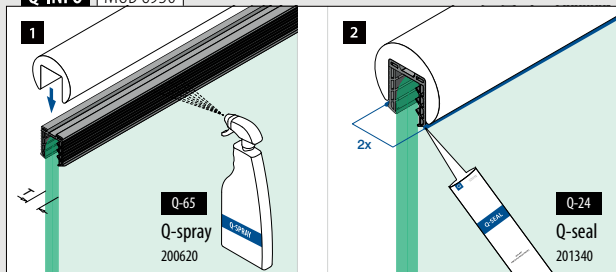

**Q-INFO** MOD 6729 / 1024

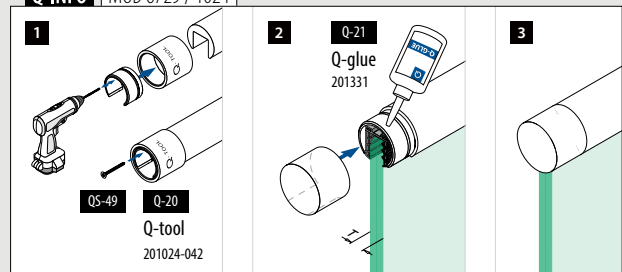



Glasleistenrohre

Glasleistenrohre

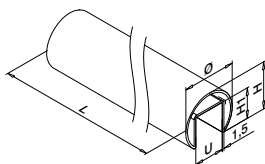

**MOD 6920**

Ø 42,4 mm

V2A	304	Gebürstet				
INDOOR			U	H	H1	
SELL OUT	136920-042-25-12		24	37	24	L = 2,5 m
	136920-042-50-12		24	37	24	L = 5 m

V4A	316	Gebürstet				
OUTDOOR						
	146920-042-50-12		24	37	24	L = 5 m

V4A	316	Hochglanzpoliert				
OUTDOOR						
	146920-042-50-10		24	37	24	L = 5 m

Ø 48,3 mm

V2A	304	Gebürstet				
INDOOR			U	H	H1	
	136920-048-50-12		27	42,6	30	L = 5 m

V4A	316	Gebürstet				
OUTDOOR						
	146920-048-50-12		27	42,6	30	L = 5 m

Ø 60,3 mm

V2A	304	Gebürstet				
INDOOR			U	H	H1	
	136920-060-50-12		34	53	34	L = 5 m

V4A	316	Gebürstet				
OUTDOOR						
	146920-060-50-12		34	53	34	L = 5 m



Glasleistenrohre

Gummieinlagen

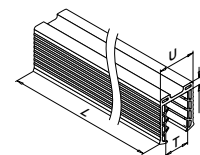

**MOD 5124**

**Zubehör**

U = 24 mm

Für monolithisches Glas	T	
205124-050-08	8 - 10	L = 5 m
205124-050-11	12	L = 5 m
205124-050-15	15	L = 5 m
205124-050-19	19	L = 5 m

205124-250-08	8 - 10	L = 25 m
205124-250-11	12	L = 25 m
205124-250-15	15	L = 25 m
205124-250-19	19	L = 25 m

**Für laminiertes Glas**

205124-050-08	8,76 - 10,76	L = 5 m
205124-050-11	11,52 - 13,52	L = 5 m
205124-050-17	16,76 - 17,52	L = 5 m
NEW 205124-050-92	20,76 - 21,52	L = 5 m

205124-250-08	8,76 - 10,76	L = 25 m
205124-250-11	11,52 - 13,52	L = 25 m
205124-250-17	16,76 - 17,52	L = 25 m
NEW 205124-250-92	20,76 - 21,52	L = 25 m

**MOD 5127**

**Zubehör**

U = 27 mm

Für monolithisches Glas	T	
205127-050-08	8 - 10	L = 5 m
205127-050-11	12	L = 5 m
205127-050-15	15	L = 5 m
205127-050-19	19	L = 5 m

**Für laminiertes Glas**

205127-050-08	8,76 - 10,76	L = 5 m
205127-050-11	11,52 - 13,52	L = 5 m
205127-050-15	16,76 - 17,52	L = 5 m
205127-050-22	20,76 - 21,52	L = 5 m
205127-050-24	24,76 - 25,52	L = 5 m

**MOD 5134**

**Zubehör**

U = 34 mm

Für monolithisches Glas	T	
205134-050-08	8 - 10	L = 5 m
205134-050-11	12	L = 5 m
205134-050-19	15	L = 5 m

**Für laminiertes Glas**

205134-050-08	8,76 - 10,76	L = 5 m
205134-050-11	11,52 - 13,52	L = 5 m
205134-050-17	16,76 - 17,52	L = 5 m
205134-050-22	20,76 - 21,52	L = 5 m
205134-050-24	24,76 - 25,52	L = 5 m
205134-050-32	31,52	L = 5 m

Q-INFO MOD 6920

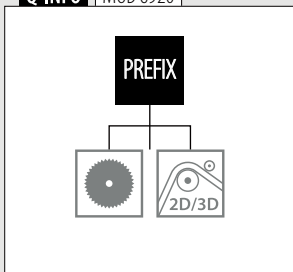

Q-INFO 316



SELL  
OUT Nur solange der Vorrat reicht.

Verbinder

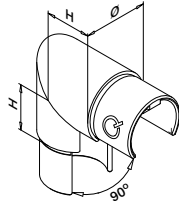

**MOD 6303**

V2A	304	Gebürstet			
INDOOR		Ø	H	☐	
	136303-042-12	42,4 x 1,5	30	2	

V4A	316	Gebürstet			
OUTDOOR		Ø	H	☐	
	146303-042-12	42,4 x 1,5	30	2	

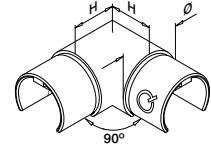

**MOD 6313**

V2A	304	Gebürstet			
INDOOR		Ø	H	☐	
	136313-042-12	42,4 x 1,5	30	2	
	136313-048-12	48,3 x 1,5	35	2	
SELL OUT	136313-060-12	60,3 x 1,5	40	2	

V4A	316	Gebürstet			
OUTDOOR		Ø	H	☐	
	146313-042-12	42,4 x 1,5	30	2	
	146313-048-12	48,3 x 1,5	35	2	
	146313-060-12	60,3 x 1,5	40	2	

V4A	316	Hochglanzpoliert			
OUTDOOR		Ø	H	☐	
	146313-042-10	42,4 x 1,5	30	2	

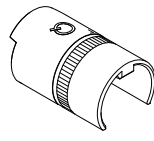
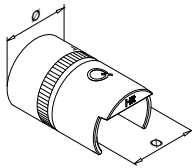

**MOD 6792 - EASY HIT®**

V2A	304	Roh			
INDOOR		Für Rohr Ø	☐		
	136792-042	42,4 x 1,5	2		
	136792-048	48,3 x 1,5	2		

V4A	316	Roh			
OUTDOOR		Für Rohr Ø	☐		
	146792-042	42,4 x 1,5	2		
	146792-048	48,3 x 1,5	2		
	146792-060	60,3 x 1,5	2		

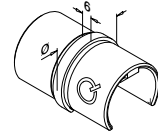

**MOD 6790**

V2A	304	Gebürstet			
INDOOR		Für Rohr Ø	☐		
	136790-042-12	42,4 x 1,5	2		
	136790-048-12	48,3 x 1,5	2		
SELL OUT	136790-060-12	60,3 x 1,5	2		

V4A	316	Gebürstet			
OUTDOOR		Für Rohr Ø	☐		
	146790-042-12	42,4 x 1,5	2		
	146790-048-12	48,3 x 1,5	2		

V4A	316	Hochglanzpoliert			
OUTDOOR		Für Rohr Ø	☐		
	146790-042-10	42,4 x 1,5	2		



**Q-INFO** | MOD 6792



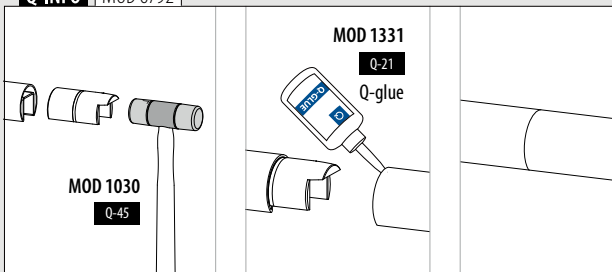

25–55°  
Abwärts

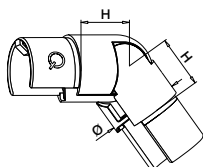

**MOD 6302**

V2A	304	Gebürstet			
INDOOR		Ø	H		
	136302-042-02-12	42,4 x 1,5	30		2
	136302-048-02-12	48,3 x 1,5	35		2
SELL OUT	136302-060-02-12	60,3 x 1,5	40		2
V4A	316	Gebürstet			
OUTDOOR		Ø	H		
	146302-042-02-12	42,4 x 1,5	30		2
	146302-048-02-12	48,3 x 1,5	35		2
	146302-060-02-12	60,3 x 1,5	40		2
V4A	316	Hochglanzpoliert			
OUTDOOR		Ø	H		
	146302-042-02-10	42,4 x 1,5	30		2



25–55°  
Aufwärts

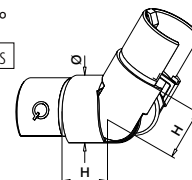

**MOD 6302**

V2A	304	Gebürstet			
INDOOR		Ø	H		
	136302-042-01-12	42,4 x 1,5	30		2
	136302-048-01-12	48,3 x 1,5	35		2
SELL OUT	136302-060-01-12	60,3 x 1,5	40		2
V4A	316	Gebürstet			
OUTDOOR		Ø	H		
	146302-042-01-12	42,4 x 1,5	30		2
	146302-048-01-12	48,3 x 1,5	35		2
	146302-060-01-12	60,3 x 1,5	40		2
V4A	316	Hochglanzpoliert			
OUTDOOR		Ø	H		
	146302-042-01-10	42,4 x 1,5	30		2



+40° / -95°  
Horizontal

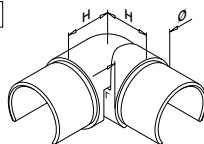

**MOD 6312**

V2A	304	Gebürstet			
INDOOR		Ø	H		
	136312-042-12	42,4 x 1,5	27		2
	136312-048-12	48,3 x 1,5	30		2
V4A	316	Gebürstet			
OUTDOOR		Ø	H		
	146312-042-12	42,4 x 1,5	27		2
	146312-048-12	48,3 x 1,5	30		2

NEW



**Q-INFO 316**

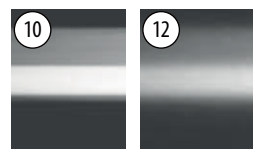

Hochglanzpoliert

Gebürstet



Nur solange der Vorrat reicht.

Glasleistenrohr/Rohr-Verbinder

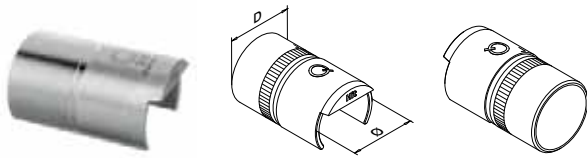

MOD 5793 - EASY HIT®

V4A	316	Roh	OUTDOOR	Für Rohr D	Für Rohr Ø	
				42,4 x 2,0	42,4 x 1,5	2
				48,3 x 2,0	48,3 x 1,5	2



Internationaler Geschmacksmusterschutz

Endbögen



MOD 6738

V2A	304	Gebürstet	INDOOR	Für Rohr Ø	L	
				42,4 x 1,5	60	2
				48,3 x 1,5	65	2

V4A	316	Gebürstet	OUTDOOR	Für Rohr Ø	L	
				42,4 x 1,5	60	2



Internationaler Geschmacksmusterschutz

Endkappen



MOD 6732

V2A	304	Gebürstet	INDOOR	Für Rohr Ø	
				42,4 x 1,5	2
				48,3 x 1,5	2

SELL OUT 136732-060-12 60,3 x 1,5 2

V4A	316	Gebürstet	OUTDOOR	Für Rohr Ø	
				42,4 x 1,5	2
				48,3 x 1,5	2
				60,3 x 1,5	2

V4A	316	Hochglanzpoliert	OUTDOOR	Für Rohr Ø	
				42,4 x 1,5	2



Wandflansche

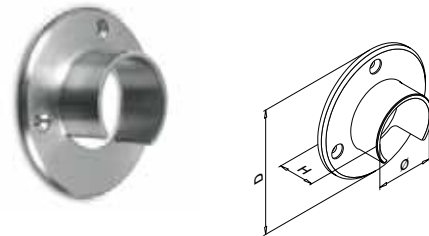

MOD 6505

V2A	304	Gebürstet	INDOOR	Für Ø	D	H			
				42,4	90	30	QS-5	473	2
				48,3	95	35	QS-5	473	2

SELL OUT 136505-060-12 60,3 107 35 QS-5 473 2

V4A	316	Gebürstet	OUTDOOR	Für Ø	D	H			
				42,4	90	30	QS-6	473	2
				48,3	95	35	QS-6	473	2
				60,3	107	35	QS-6	473	2

V4A	316	Hochglanzpoliert	OUTDOOR	Für Ø	D	H			
				42,4	90	30	QS-6	473	2



Q-INFO MOD 6738

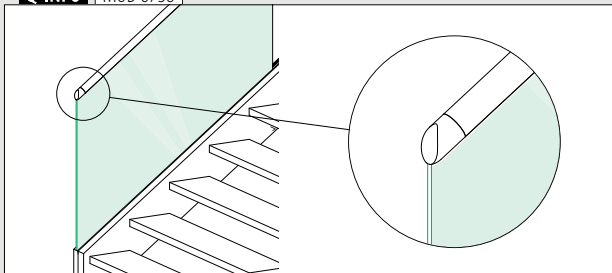

Q-INFO MOD 5793

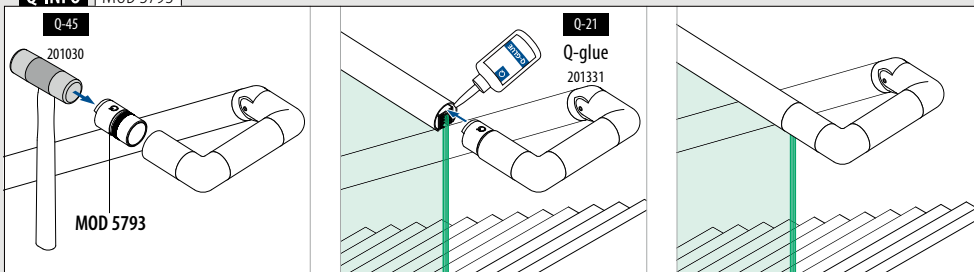



Glasleistenrohre

**Glasleistenrohre**

166920-042-50-00 18

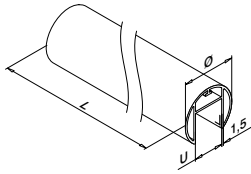

**MOD 6920**

Aluminium	Roh	U	Ø	
166920-042-50-00		24	42,4	L = 5 m
Aluminium	Gebürstet			
<b>OUTDOOR</b>				
166920-042-50-18		24	42,4	L = 5 m



Internationaler Geschmacksmusterschutz

Glasleistenrohre

**Ecken**

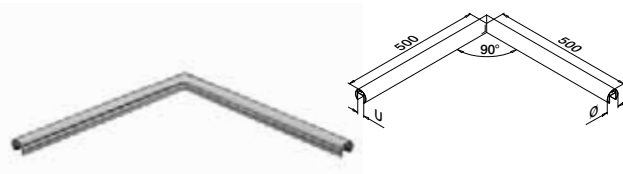

**MOD 6320**

Aluminium	Roh	U	Ø	
166320-042-00		24	42,4 x 1,5	1
Aluminium	Gebürstet			
<b>OUTDOOR</b>				
166320-042-18		24	42,4 x 1,5	1

Internationaler Geschmacksmusterschutz

Glasleistenrohre

**Endkappen**

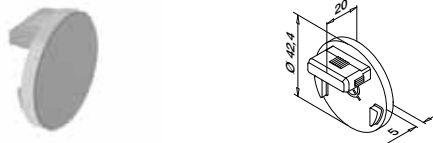

**MOD 6732 - EASY HIT®**

Aluminium	Roh	Für Ø	
166732-042-00		42,4 x 1,5	2
Aluminium	Gebürstet		
<b>OUTDOOR</b>			
166732-042-18		42,4 x 1,5	2



Internationaler Geschmacksmusterschutz

Glasleistenrohre

**Gummieinlagen**

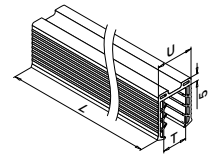

**MOD 5124**

**Zubehör**

U = 24 mm

Für monolithisches Glas	T	
205124-050-08	8 - 10	L = 5 m
205124-050-11	12	L = 5 m
205124-050-15	15	L = 5 m
205124-050-19	19	L = 5 m
205124-250-08	8 - 10	L = 25 m
205124-250-11	12	L = 25 m
205124-250-15	15	L = 25 m
205124-250-19	19	L = 25 m

**Für laminiertes Glas**

205124-050-08	8,76 - 10,76	L = 5 m
205124-050-11	11,52 - 13,52	L = 5 m
205124-050-17	16,76 - 17,52	L = 5 m
<b>NEW</b> 205124-050-92	20,76 - 21,52	L = 5 m
205124-250-08	8,76 - 10,76	L = 25 m
205124-250-11	11,52 - 13,52	L = 25 m
205124-250-17	16,76 - 17,52	L = 25 m
<b>NEW</b> 205124-250-92	20,76 - 21,52	L = 25 m

Q-INFO MOD 6920

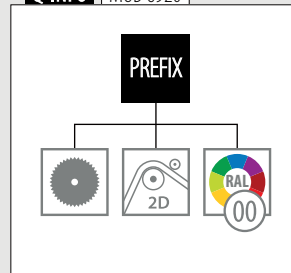

Q-INFO Aluminium



Q-INFO MOD 6920 / 5124 / 6732

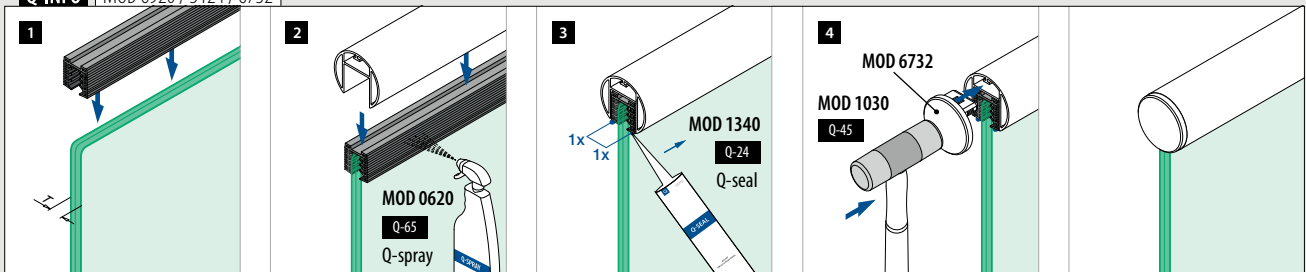

Verbinder

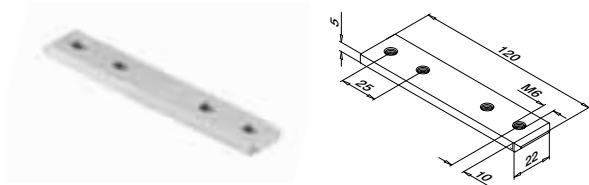

MOD 6795

<b>Aluminium</b>	Roh		
166795-339	QS-261	474	2

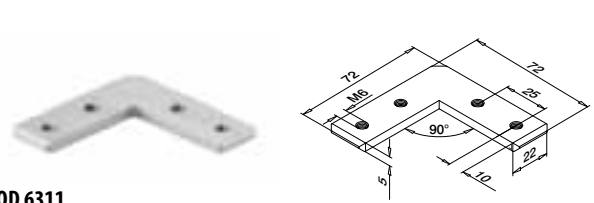

MOD 6311

<b>Aluminium</b>	Roh		
166311-339	QS-261	474	2

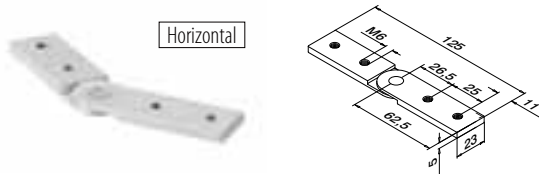

MOD 6797

<b>Aluminium</b>	Roh		
166797	QS-261	474	2

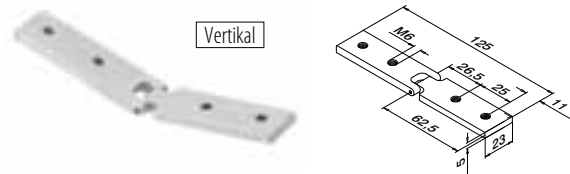

MOD 6798

<b>Aluminium</b>	Roh		
166798	QS-261	474	2

Q-INFO MOD 6311

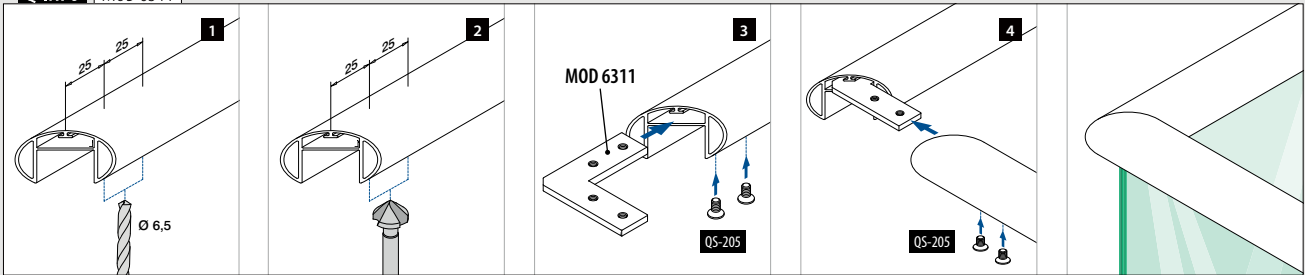

Q-INFO MOD 6797

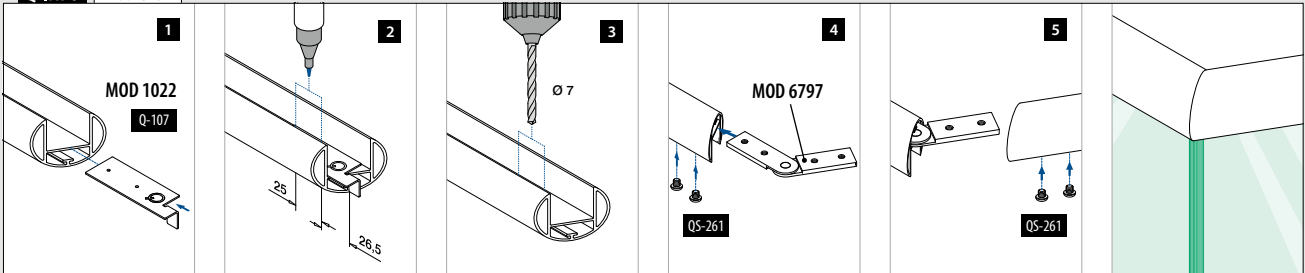

Q-INFO MOD 6798

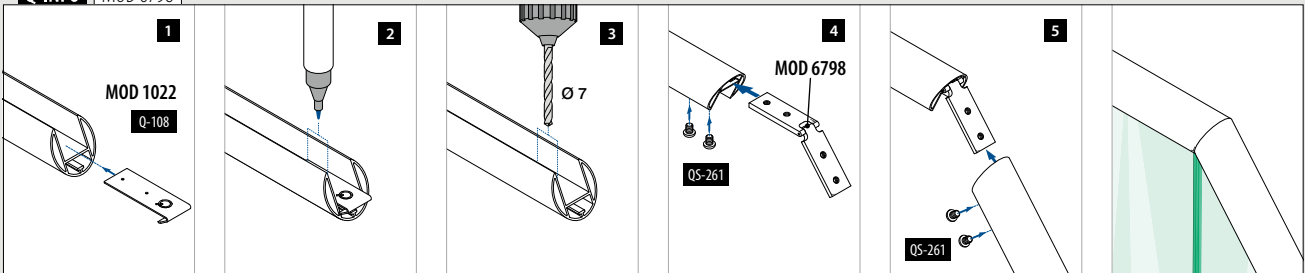

Q-INFO MOD 6798

Nach oben

Schneiden	45°	40°	35°	30°	25°	20°	15°	10°	5°	0°
Außenwinkel	90°	100°	110°	120°	130°	140°	150°	160°	170°	180°
Abstand zum Rand (x)	30,5	30,0	29,5	29,0	28,5	28,0	27,5	27,0	27,0	26,5

Nach unten

Schneiden	0°	5°	10°	15°	20°	25°	30°	35°	40°	45°
Innenwinkel	180°	170°	160°	150°	140°	130°	120°	110°	100°	90°
Abstand zum Rand (x)	26,5	26,5	26,0	26,0	25,5	25,5	25,0	24,5	24,5	24,0

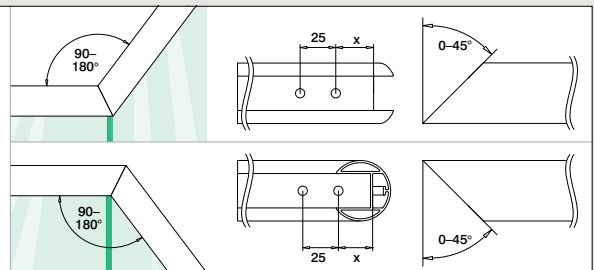

Glasleistenrohre

Glasleistenrohre

Quadratisch

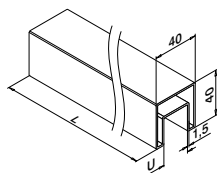

**MOD 6924**

V2A	304	Gebürstet			
INDOOR			U	<input type="checkbox"/>	
SELL OUT	136924-040-25-12	24	40 x 40	L = 2,5 m	
	136924-040-50-12	24	40 x 40	L = 5 m	
V4A	316	Gebürstet			
OUTDOOR			U	<input type="checkbox"/>	
	146924-040-25-12	24	40 x 40	L = 2,5 m	
	146924-040-50-12	24	40 x 40	L = 5 m	



Glasleistenrohre

Gummieinlagen

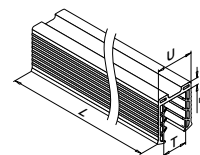

**MOD 5124**

Zubehör		
U = 24 mm		
Für monolithisches Glas	T	
205124-050-08	8 - 10	L = 5 m
205124-050-11	12	L = 5 m
205124-050-15	15	L = 5 m
205124-050-19	19	L = 5 m
205124-250-08	8 - 10	L = 25 m
205124-250-11	12	L = 25 m
205124-250-15	15	L = 25 m
205124-250-19	19	L = 25 m
Für laminiertes Glas		
205124-050-08	8,76 - 10,76	L = 5 m
205124-050-11	11,52 - 13,52	L = 5 m
205124-050-17	16,76 - 17,52	L = 5 m
<b>NEW</b> 205124-050-92	20,76 - 21,52	L = 5 m
205124-250-08	8,76 - 10,76	L = 25 m
205124-250-11	11,52 - 13,52	L = 25 m
205124-250-17	16,76 - 17,52	L = 25 m
<b>NEW</b> 205124-250-92	20,76 - 21,52	L = 25 m

**Q-INFO** MOD 6924

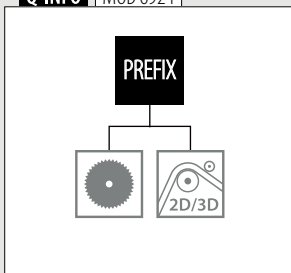

**Q-INFO** MOD 6924 / 5124 / 6734

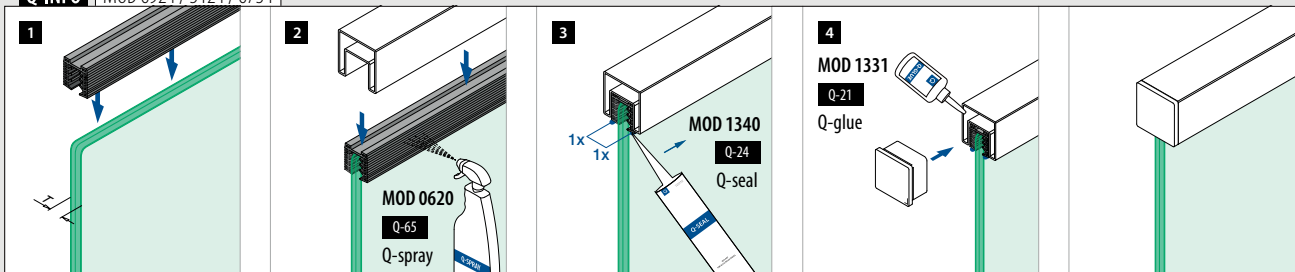

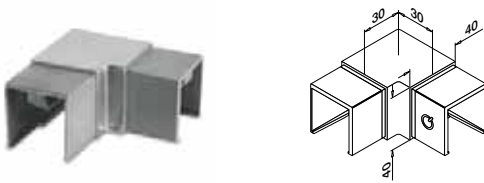

**MOD 6343**

<b>V2A</b>	<b>304</b>	Gebürstet		
	<b>INDOOR</b>		<input type="checkbox"/>	
	136343-040-12		40 x 40	2
<b>V4A</b>	<b>316</b>	Gebürstet		
	<b>OUTDOOR</b>			
	146343-040-12		40 x 40	2



**MOD 6794**

<b>V2A</b>	<b>304</b>	Gebürstet		
	<b>INDOOR</b>		<input type="checkbox"/>	
	136794-040-12		40 x 40	2
<b>V4A</b>	<b>316</b>	Gebürstet		
	<b>OUTDOOR</b>			
	146794-040-12		40 x 40	2

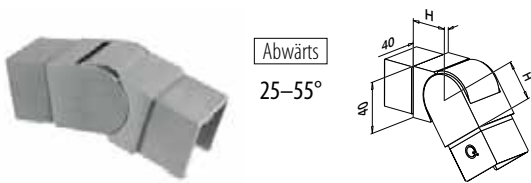

**MOD 6342**

<b>V2A</b>	<b>304</b>	Gebürstet			
	<b>INDOOR</b>		<input type="checkbox"/>	<b>H</b>	
	136342-040-02-12		40 x 40	30	2
<b>V4A</b>	<b>316</b>	Gebürstet			
	<b>OUTDOOR</b>				
	146342-040-02-12		40 x 40	30	2



**MOD 6342**

<b>V2A</b>	<b>304</b>	Gebürstet			
	<b>INDOOR</b>		<input type="checkbox"/>	<b>H</b>	
	136342-040-01-12		40 x 40	30	2
<b>V4A</b>	<b>316</b>	Gebürstet			
	<b>OUTDOOR</b>				
	146342-040-01-12		40 x 40	30	2



**MOD 6734**

<b>V2A</b>	<b>304</b>	Gebürstet		
	<b>INDOOR</b>		<input type="checkbox"/>	
	136734-040-12		40 x 40	2
<b>V4A</b>	<b>316</b>	Gebürstet		
	<b>OUTDOOR</b>			
	146734-040-12		40 x 40	2

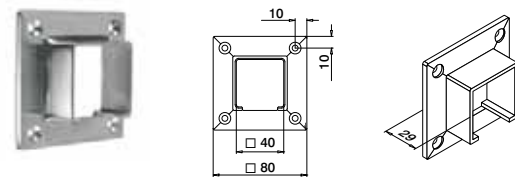

**MOD 6545**

<b>V2A</b>	<b>304</b>	Gebürstet			
	<b>INDOOR</b>		<input type="checkbox"/>		
	136545-040-12		40 x 40	QS-7	473
<b>V4A</b>	<b>316</b>	Gebürstet			
	<b>OUTDOOR</b>				
	146545-040-12		40 x 40	QS-50	473





Glasleistenrohre

Glasleistenrohre

Quadratisch

166924-040-50-00 18 82

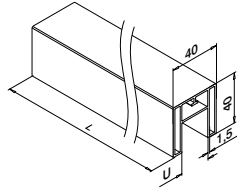
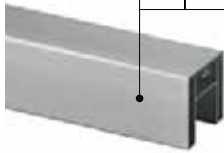

MOD 6924

Aluminium	Roh	U	□	⊞
166924-040-50-00		24	40 x 40	L = 5 m
Aluminium	Gebürstet			
<b>OUTDOOR</b>				
166924-040-50-18		24	40 x 40	L = 5 m
Aluminium	Black Line			
<b>OUTDOOR</b>				
<b>NEW</b> 166924-040-50-82		24	40 x 40	L = 5 m



Internationaler Geschmacksmusterschutz

Glasleistenrohre

Gummieinlagen

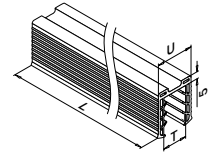

MOD 5124

Zubehör			
U = 24 mm			
Für monolithisches Glas	T	⊞	
205124-050-08	8 - 10		L = 5 m
205124-050-11	12		L = 5 m
205124-050-15	15		L = 5 m
205124-050-19	19		L = 5 m
Für laminiertes Glas			
205124-050-08	8,76 - 10,76		L = 5 m
205124-050-11	11,52 - 13,52		L = 5 m
205124-050-17	16,76 - 17,52		L = 5 m
<b>NEW</b> 205124-050-92	20,76 - 21,52		L = 5 m

Glasleistenrohre

Ecken

Quadratisch

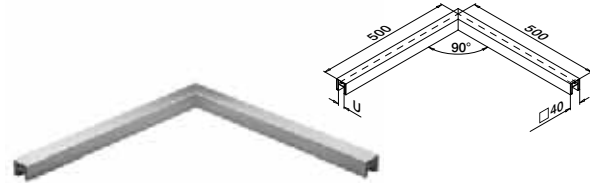

MOD 6324

Aluminium	Gebürstet	U	□	⊞
<b>OUTDOOR</b>				
166324-040-18		24	40 x 40 x 1,5	1
Aluminium	Black Line			
<b>OUTDOOR</b>				
<b>NEW</b> 166324-040-82		24	40 x 40 x 1,5	1

Glasleistenrohre

Endkappen

Quadratisch

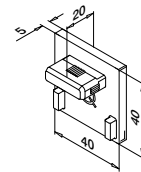

MOD 6734 - EASY HIT®

Aluminium	Roh	□	⊞
166734-040-00		40 x 40	2
Aluminium	Gebürstet		
<b>OUTDOOR</b>			
166734-040-18		40 x 40	2
Aluminium	Black Line		
<b>OUTDOOR</b>			
<b>NEW</b> 166734-040-82		40 x 40	2



Internationaler Geschmacksmusterschutz

Q-INFO Aluminium

00

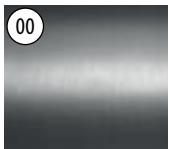

Roh

18

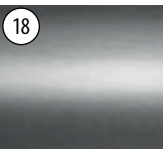

Gebürstet,  
anodisiert

82



Schwarz, matt,  
strukturiert

RAL 9005

Pulver-  
beschichtet

Q-INFO MOD 6924

PREFIX

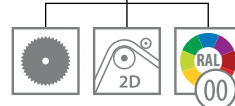

Q-INFO MOD 6924 / 5124 / 6734

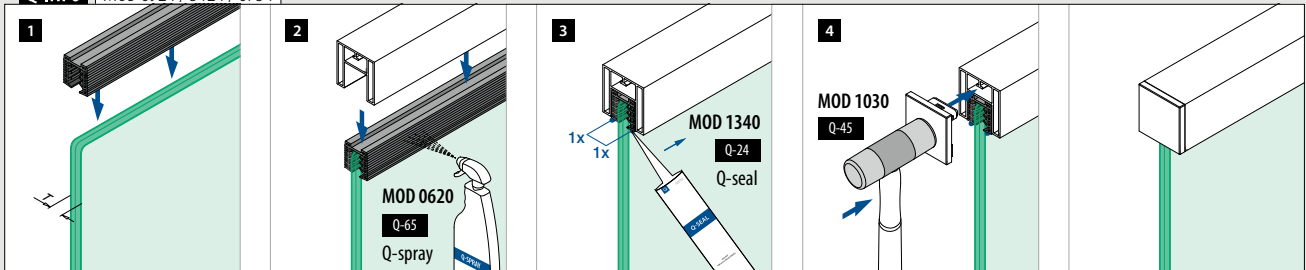

Verbinder

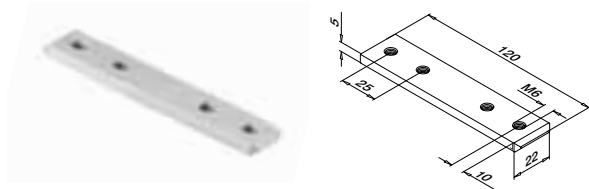

MOD 6795

<b>Aluminium</b>	Roh		
166795-339	QS-261	474	2

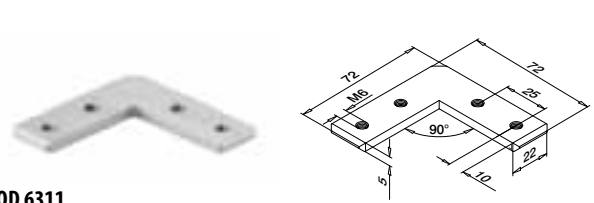

MOD 6311

<b>Aluminium</b>	Roh		
166311-339	QS-261	474	2

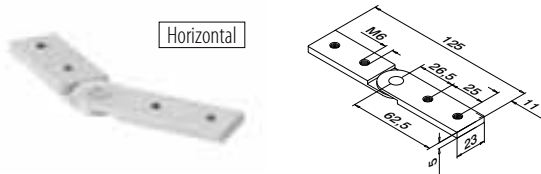

MOD 6797

<b>Aluminium</b>	Roh		
166797	QS-261	474	2

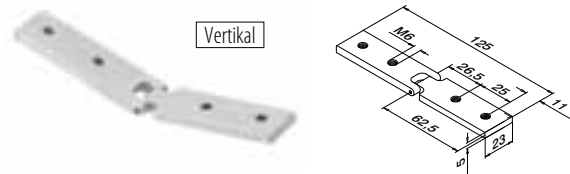

MOD 6798

<b>Aluminium</b>	Roh		
166798	QS-261	474	2

Q-INFO MOD 6311

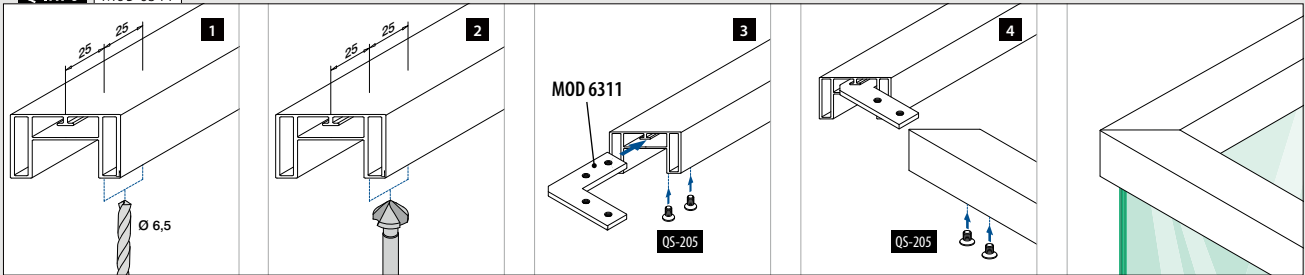

Q-INFO MOD 6797

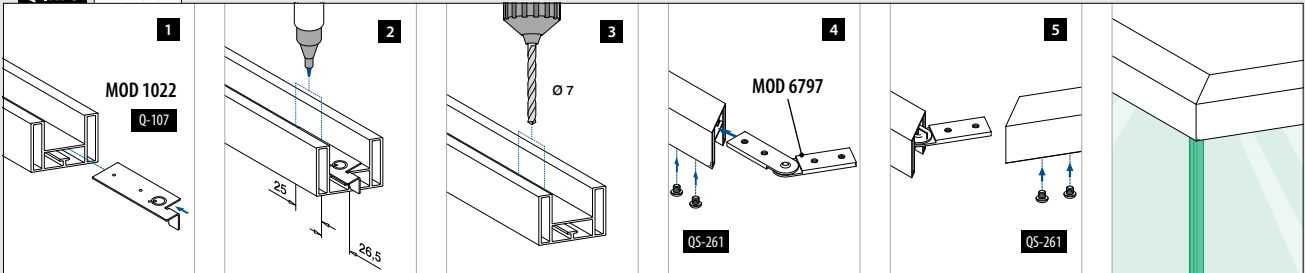

Q-INFO MOD 6798

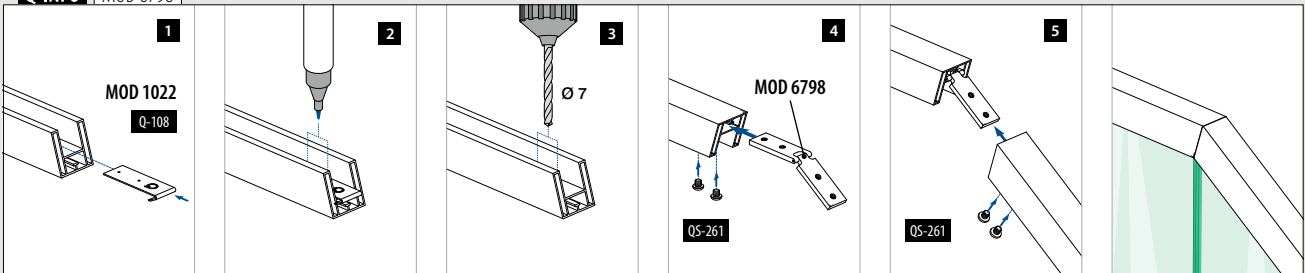

Q-INFO MOD 6798

Nach oben

Schneiden	45°	40°	35°	30°	25°	20°	15°	10°	5°	0°
Außenwinkel	90°	100°	110°	120°	130°	140°	150°	160°	170°	180°
Abstand zum Rand (x)	30,5	30,0	29,5	29,0	28,5	28,0	27,5	27,0	27,0	26,5

Nach unten

Schneiden	0°	5°	10°	15°	20°	25°	30°	35°	40°	45°
Innenwinkel	180°	170°	160°	150°	140°	130°	120°	110°	100°	90°
Abstand zum Rand (x)	26,5	26,5	26,0	26,0	25,5	25,5	25,0	24,5	24,5	24,0

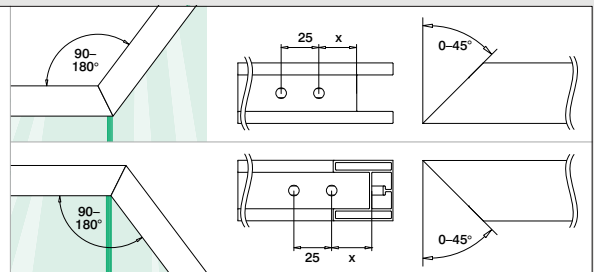



Glasleistenrohre

Glasleistenrohre

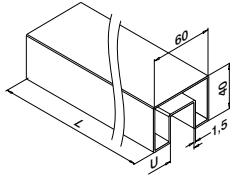
Rechteckig 



**MOD 6924**

V2A	<b>304</b>	Gebürstet		
<b>INDOOR</b>		<b>U</b>		
SELL OUT	136924-640-50-12	24	60 x 40	L = 5 m
V4A	<b>316</b>	Gebürstet		
<b>OUTDOOR</b>				
	146924-640-50-12	24	60 x 40	L = 5 m



Glasleistenrohre

Gummieinlagen

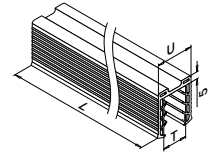

**MOD 5124**

<b>Zubehör</b>		
U = 24 mm		
<b>Für monolithisches Glas</b>		<b>T</b> 
205124-050-08	8 - 10	L = 5 m
205124-050-11	12	L = 5 m
205124-050-15	15	L = 5 m
205124-050-19	19	L = 5 m
<hr/>		
205124-250-08	8 - 10	L = 25 m
205124-250-11	12	L = 25 m
205124-250-15	15	L = 25 m
205124-250-19	19	L = 25 m
<hr/>		
<b>Für laminiertes Glas</b>		
205124-050-08	8,76 - 10,76	L = 5 m
205124-050-11	11,52 - 13,52	L = 5 m
205124-050-17	16,76 - 17,52	L = 5 m
<b>NEW</b> 205124-050-92	20,76 - 21,52	L = 5 m
<hr/>		
205124-250-08	8,76 - 10,76	L = 25 m
205124-250-11	11,52 - 13,52	L = 25 m
205124-250-17	16,76 - 17,52	L = 25 m
<b>NEW</b> 205124-250-92	20,76 - 21,52	L = 25 m

**Q-INFO** | MOD 6924

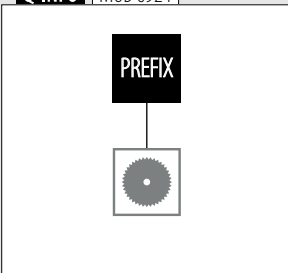

**Q-INFO** | MOD 6924 / 5124 / 6734

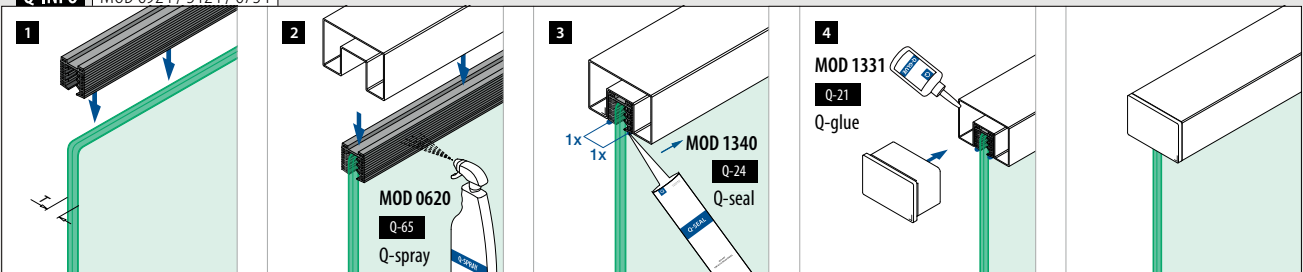

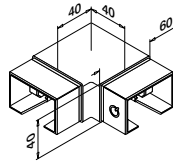

**MOD 6343**

<b>V2A</b>	<b>304</b>	Gebürstet		
	<b>INDOOR</b>	<b>Für</b> <input type="checkbox"/>		
<b>SELL OUT</b>	136343-640-12	60 x 40	2	
<b>V4A</b>	<b>316</b>	Gebürstet		
	<b>OUTDOOR</b>			
	146343-640-12	60 x 40	2	

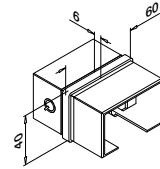

**MOD 6794**

<b>V2A</b>	<b>304</b>	Gebürstet		
	<b>INDOOR</b>	<b>Für</b> <input type="checkbox"/>		
<b>SELL OUT</b>	136794-640-12	60 x 40	2	
<b>V4A</b>	<b>316</b>	Gebürstet		
	<b>OUTDOOR</b>			
	146794-640-12	60 x 40	2	



25–55°  
Abwärts

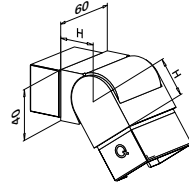

**MOD 6342**

<b>V2A</b>	<b>304</b>	Gebürstet		
	<b>INDOOR</b>	<b>Für</b> <input type="checkbox"/>	<b>H</b>	
<b>SELL OUT</b>	136342-640-02-12	60 x 40	30	2
<b>V4A</b>	<b>316</b>	Gebürstet		
	<b>OUTDOOR</b>			
	146342-640-02-12	60 x 40	30	2



25–55°  
Aufwärts

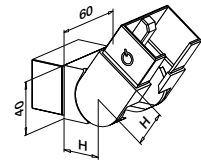

**MOD 6342**

<b>V2A</b>	<b>304</b>	Gebürstet		
	<b>INDOOR</b>	<b>Für</b> <input type="checkbox"/>	<b>H</b>	
<b>SELL OUT</b>	136342-640-01-12	60 x 40	30	2
<b>V4A</b>	<b>316</b>	Gebürstet		
	<b>OUTDOOR</b>			
	146342-640-01-12	60 x 40	30	2

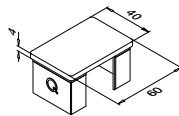

**MOD 6734**

<b>V2A</b>	<b>304</b>	Gebürstet		
	<b>INDOOR</b>	<b>Für</b> <input type="checkbox"/>		
<b>SELL OUT</b>	136734-640-12	60 x 40	2	
<b>V4A</b>	<b>316</b>	Gebürstet		
	<b>OUTDOOR</b>			
	146734-640-12	60 x 40	2	

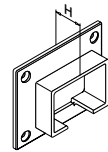
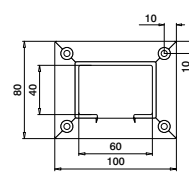
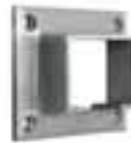

**MOD 6545**

<b>V2A</b>	<b>304</b>	Gebürstet		
	<b>INDOOR</b>	<b>Für</b> <input type="checkbox"/>	<b>H</b>	
<b>SELL OUT</b>	136545-640-12	60 x 40	29	QS-7  473
<b>V4A</b>	<b>316</b>	Gebürstet		
	<b>OUTDOOR</b>			
	146545-640-12	60 x 40	29	QS-50  473





Glasleistenrohre

Glasleistenrohre

Rechteckig

166924-654-50-00 00 08

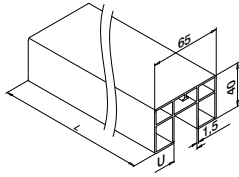
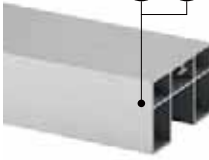

MOD 6924

Aluminium Roh

	U	<input type="checkbox"/>	<input type="checkbox"/>
166924-654-50-00	24	65 x 40	L = 5 m

Aluminium Matt Silbereffekt

OUTDOOR

SELL OUT

166924-654-50-08	24	65 x 40	L = 5 m
------------------	----	---------	---------



Internationaler Geschmacksmusterschutz

Glasleistenrohre

Endkappen

Rechteckig

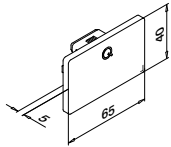

MOD 6734 - EASY HIT®

Aluminium Roh

	Für <input type="checkbox"/>	<input type="checkbox"/>
166734-654-00	65 x 40	2

Aluminium Matt Silbereffekt

OUTDOOR

SELL OUT

166734-654-08	65 x 40	2
---------------	---------	---



Internationaler Geschmacksmusterschutz

Glasleistenrohre

Gummieinlagen

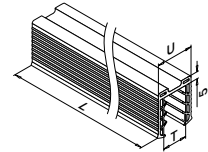

MOD 5124

Zubehör

U = 24 mm

Für monolithisches Glas	T	<input type="checkbox"/>
205124-050-08	8 - 10	L = 5 m
205124-050-11	12	L = 5 m
205124-050-15	15	L = 5 m
205124-050-19	19	L = 5 m

Für laminiertes Glas

205124-050-08	8,76 - 10,76	L = 5 m
205124-050-11	11,52 - 13,52	L = 5 m
205124-050-17	16,76 - 17,52	L = 5 m
NEW 205124-050-92	20,76 - 21,52	L = 5 m

Glasleistenrohre

Wandflansche

Rechteckig

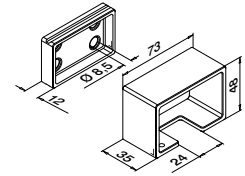

MOD 6545

Aluminium Roh

	Für <input type="checkbox"/>	<input type="checkbox"/>	<input type="checkbox"/>
166545-654-00	65 x 40	QS-55 <input type="checkbox"/> 472 / QS-20 <input type="checkbox"/> 474	2



Internationaler Geschmacksmusterschutz

SELL OUT Nur solange der Vorrat reicht.

Q-INFO MOD 6924

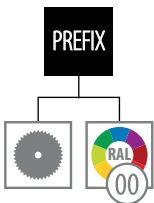

Q-INFO Aluminium

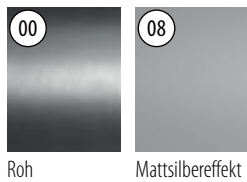

Q-INFO MOD 6924



Fügen Sie mithilfe des MOD 6926 Glasleistenrohres eine LED-Beleuchtung (Linear Light) hinzu

Q-INFO MOD 6924 / 5124 / 6734

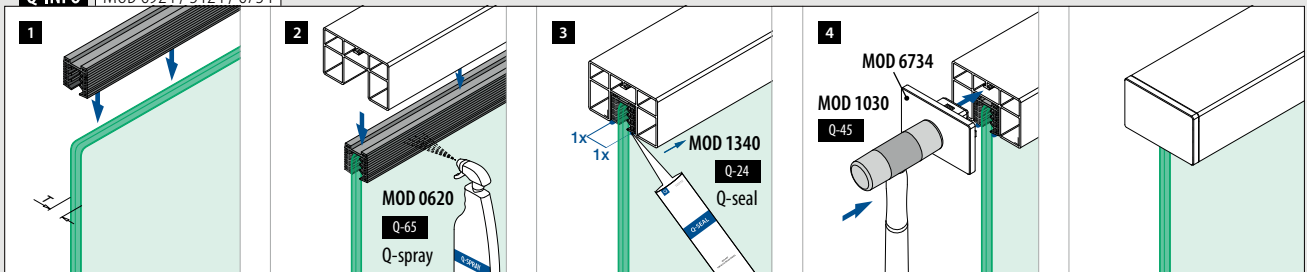

Verbinder

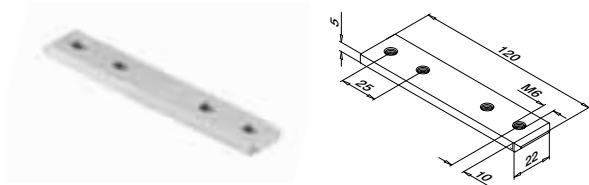

MOD 6795

<b>Aluminium</b>	Roh		
166795-339	QS-261	474	2

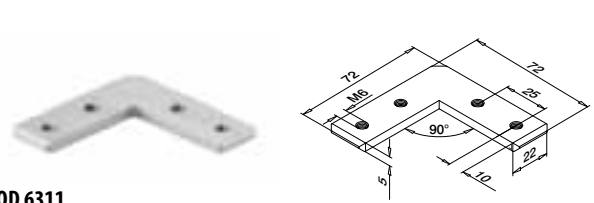

MOD 6311

<b>Aluminium</b>	Roh		
166311-339	QS-261	474	2

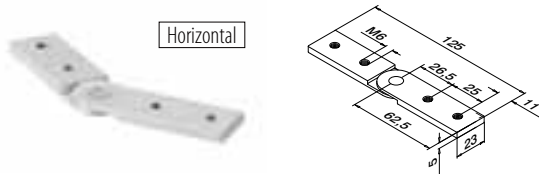

MOD 6797

<b>Aluminium</b>	Roh		
166797	QS-261	474	2

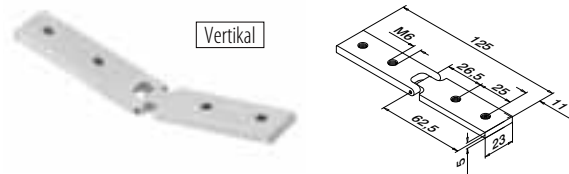

MOD 6798

<b>Aluminium</b>	Roh		
166798	QS-261	474	2

Q-INFO MOD 6311

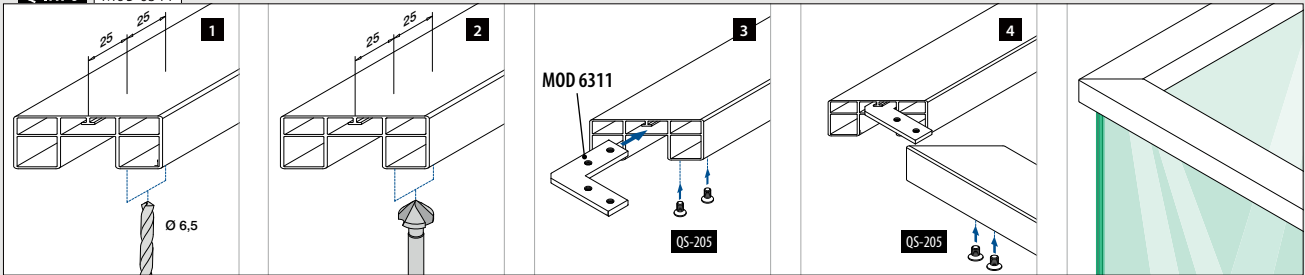

Q-INFO MOD 6797

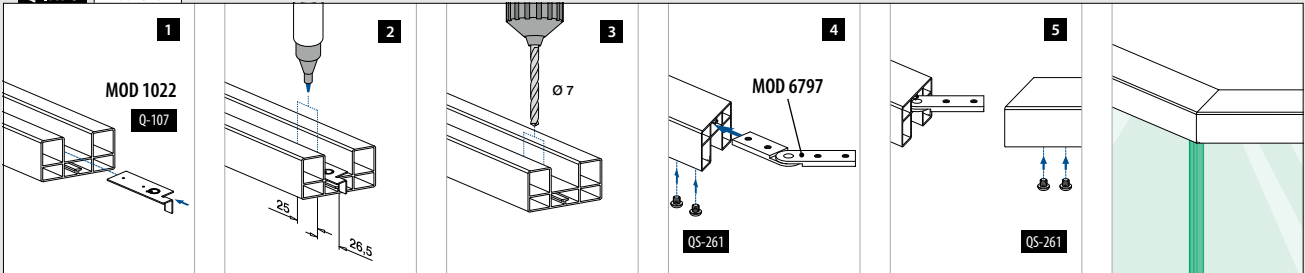

Q-INFO MOD 6798

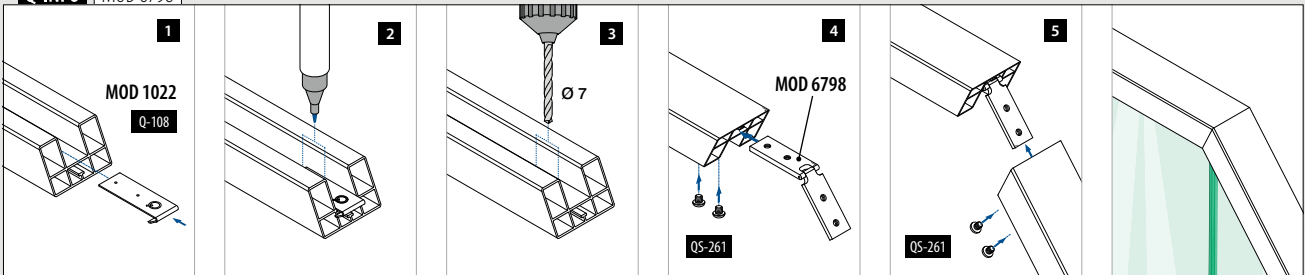

Q-INFO MOD 6798

Nach oben

Schneiden	45°	40°	35°	30°	25°	20°	15°	10°	5°	0°
Außenwinkel	90°	100°	110°	120°	130°	140°	150°	160°	170°	180°
Abstand zum Rand (x)	30,5	30,0	29,5	29,0	28,5	28,0	27,5	27,0	27,0	26,5

Nach unten

Schneiden	0°	5°	10°	15°	20°	25°	30°	35°	40°	45°
Innenwinkel	180°	170°	160°	150°	140°	130°	120°	110°	100°	90°
Abstand zum Rand (x)	26,5	26,5	26,0	26,0	25,5	25,5	25,0	24,5	24,5	24,0

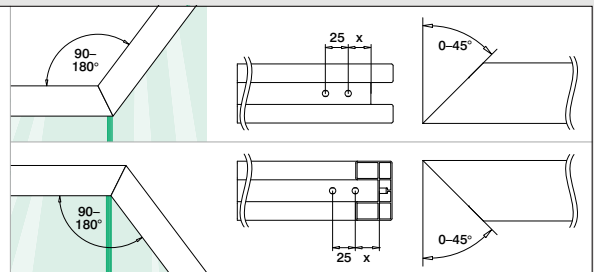

Glasleistenrohre

Glasleistenrohre

HYBRID 33x39

166911-339-50-00 08 18 82

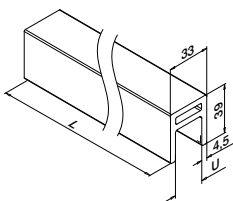
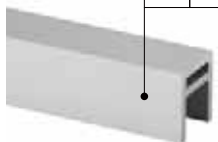

MOD 6911

Aluminium Roh

	<b>U</b>	
166911-339-50-00	24	L = 5 m

Aluminium Matt Silbereffekt

	<b>OUTDOOR</b>	
166911-339-50-08	24	L = 5 m

SELL OUT

Aluminium Gebürstet

	<b>OUTDOOR</b>	
166911-339-50-18	24	L = 5 m

NEW

Aluminium Black Line

	<b>OUTDOOR</b>	
166911-339-50-82	24	L = 5 m

NEW



Internationaler Geschmacksmusterschutz

Glasleistenrohre

Gummieinlagen

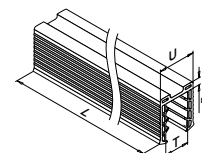

MOD 5124

Zubehör

U = 24 mm

Für monolithisches Glas	<b>T</b>	
205124-050-08	8 - 10	L = 5 m

Für laminiertes Glas

205124-050-08	8,76 - 10,76	L = 5 m
205124-050-11	11,52 - 13,52	L = 5 m

Glasleistenrohre

Wandflansche

HYBRID 33x39

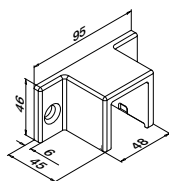

MOD 6515

V4A	<b>316</b>	Gebürstet		
	<b>OUTDOOR</b>			
146515-339-12	QS-214	470		2

V4A	<b>316</b>	Black Line		
	<b>OUTDOOR</b>			
146515-339-82	QS-214	470		2



Q-INFO Aluminium

<b>00</b> Roh	<b>08</b> Mattsilbereffekt	<b>18</b> Gebürstet, anodisiert	<b>82 RAL 9005</b> Pulverbeschichtet Schwarz, matt, strukturiert
------------------	-------------------------------	------------------------------------	--

Q-INFO 316

<b>12</b> Gebürstet	<b>82 RAL 9005</b> Pulverbeschichtet Schwarz, matt, strukturiert
------------------------	--

Q-INFO MOD 6911

PREFIX

Q-INFO



Links / rechts

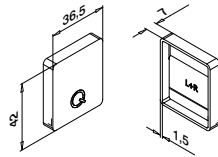

**MOD 6913**

<b>Aluminium</b>	Roh	
166913-339-00		2
<b>Aluminium</b>	Matt Silbereffekt	
<b>OUTDOOR</b>		
<b>SELL OUT</b>		
166913-339-08		2
<b>Aluminium</b>	Gebürstet	
<b>OUTDOOR</b>		
<b>NEW</b>		
166913-339-18		2
<b>Aluminium</b>	Black Line	
<b>OUTDOOR</b>		
<b>NEW</b>		
166913-339-82		2

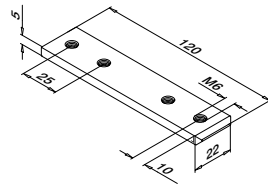

**MOD 6795**

<b>Aluminium</b>	Roh	
166795-339	QS-261	474
		2

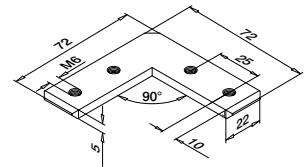

**MOD 6311**

<b>Aluminium</b>	Roh	
166311-339	QS-261	474
		2

**SELL OUT** Nur solange der Vorrat reicht.

**Q-INFO** MOD 6311

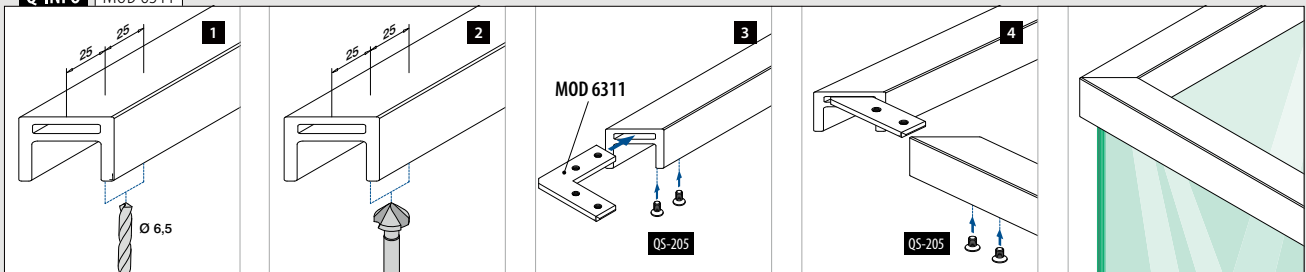





# 2

# SYSTEME FÜR FRANZÖSISCHE BALKONE

Easy Glass® View	190 - 197
Easy Glass® MOD 6507-6508	198 - 209
Mit Glasklemmen	210 - 211
Mit Glasadaptern	212 - 217
Fensterabsturzstangen	218 - 231





# EASY GLASS® MOD 6507 / 6508

198



Finden Sie alle Informationen zu Französischen Balkonen online:



<https://q-ne.ws/JulietBalcony23>

## MIT GLAS-ADAPTERN

212

## MIT GLAS-KLEMMEN

210

## FENSTER-ABSTURZ-STANGEN

218

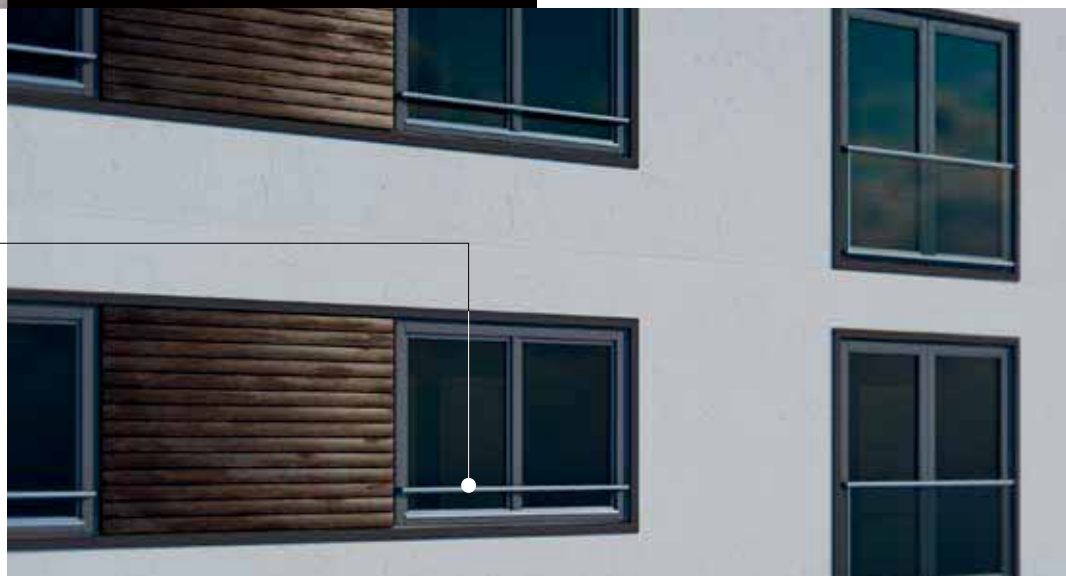

# VIELSEITIG UND FAST UNSICHTBAR

Raumhohe Fenster sind sowohl in Wohn- als auch Bürogebäuden äußerst beliebt, da die Bewohner und Benutzer vom maximierten Tageslichteinfall profitieren. Für eine ausreichende Absturzsicherung ist jedoch ein französischer Balkon an den Fenstern notwendig.

In unserem Sortiment finden Sie zwei Systeme, die speziell für diesen Einsatz entwickelt wurden: Easy Glass® View, das sowohl an der Fassade, in der Laibung oder auf dem Fensterrahmen montiert werden kann, und Easy Glass® MOD 6507-6508 mit seinen runden oder eckigen Wandflanschen und Glasleistenrohren.

Daneben gibt es aber noch weitere Lösungen, um gläserne französische Balkone zu kreieren – zum Beispiel mit den Q-railing Glasklemmen und Glasadaptern. Für eine Absicherung an hohen Fenstern können Sie auch die neuen schlichten Absturzstangen verwenden. Wählen Sie dafür aus unterschiedlichen runden oder eckigen Elementen aus.



EASY GLASS®  
VIEW

190



Q-railing





**Beanspruchung:** Leicht und mittel  
**Verwendung:** Innen- und Außenbereich  
**Montage:** Wandmontage  
(Fassade, Fenster oder Laibung)  
**Anwendung:** Französische Balkone  
**Material:** Aluminium (gebürstet anodisiert,  
roh und pulverbeschichtet)  
**Glasstärke:** 12 bis 21,52 mm

Finden Sie alle Informationen  
zu Easy Glass View online:



[https://q-ne.ws/  
View23](https://q-ne.ws/View23)

# EASY GLASS<sup>®</sup> VIEW



## Minimalistische französische Balkone für maximalen Halt

Den fast unsichtbaren französischen Balkon Easy Glass® View können Sie entweder an der Fassade, in der Fensterlaibung oder direkt auf dem Fensterrahmen montieren. Die schlanken Aluminium-Profile können zudem nach Wunsch pulverbeschichtet werden – passend zur Fenster- oder Fassadenfarbe.

Easy Glass® View	DE
Max. Holmlast (kN/m)	1,0
Max. Breite (Meter)	3,3



Bitte beachten Sie die Spezifikationen wie Befestigungs- und Glasmaße sowie Glastypen der jeweiligen Zertifikate.

### International getestet/berechnet/zertifiziert:



- 1 Schaffen Sie einen praktisch unsichtbaren französischen Balkon dank der extrem schlanken Profile und unsichtbaren Montagepunkte von Easy Glass View.
- 2 Wählen Sie aus drei Montagemöglichkeiten aus: Fassadenmontage, Montage in der Fensterlaibung oder Fensterrahmenmontage.



## EASY GLASS® VIEW VARIANTEN

- Montage mit Ankern oder Schrauben (abhängig vom Untergrund)
- Die Montage in der Laibung kann von innen vorgenommen werden
- Profile und Endkappen können pulverbeschichtet werden

Fassadenmontage

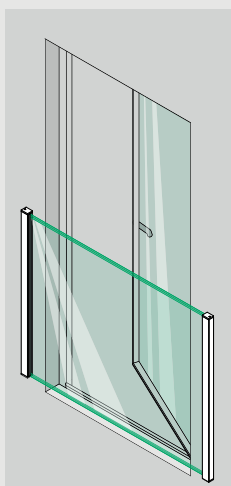

Fensterrahmenmontage

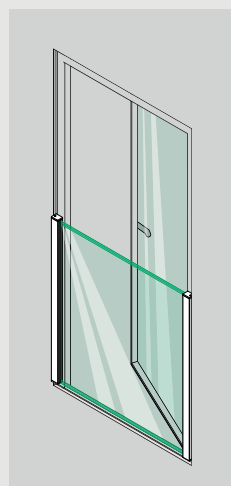

Montage in der Fensterlaibung

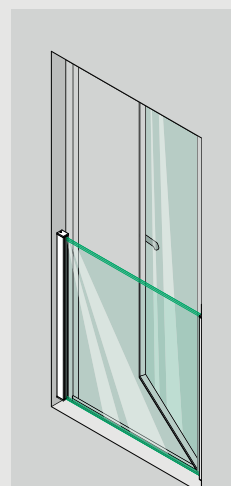

Montage mit Mittelprofil

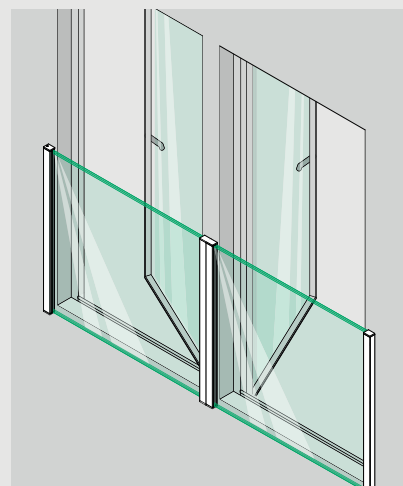

Wandprofil

Easy Glass® View

Fassadenmontage

Montage in der Fensterlaibung

Rahmenmontage

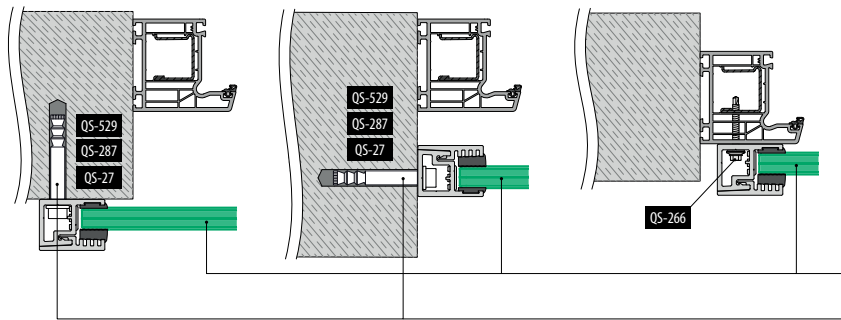

Bitte beachten Sie die Spezifikationen wie Befestigungs- und Glasmaße sowie Glasstypen der jeweiligen Zertifikate und statischen Berechnungen.

VSG aus ESG: 160 - 161

Anker: 459 - 465

Montage mit Mittelprofil

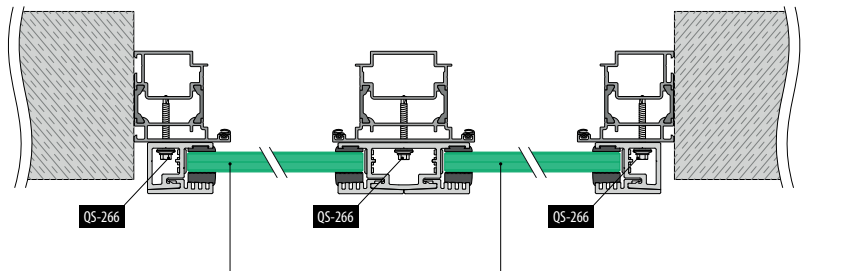

VSG aus ESG: 160 - 161

Wandprofil

Profilsets zur Wandmontage

Vorgebohrt

Inklusive: 2 Profile für 1100 mm hohes Glas, 4 Endkappen und 4 Abdeckstopfen

Montage in der Fensterlaibung

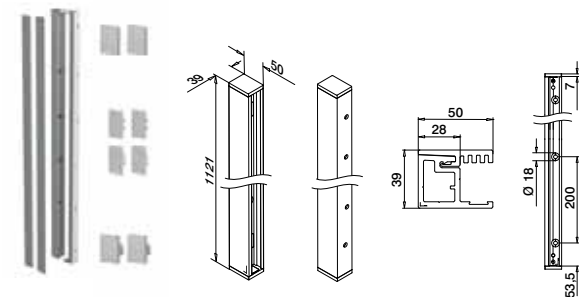

MOD 6839

Aluminium Roh

166839-011-02-00 459 - 465 L = 2x 1,1 m

Aluminium Gebürstet

OUTDOOR

166839-011-02-18 459 - 465 L = 2x 1,1 m



Inklusive: 2 Profile für 1100 mm hohes Glas, 4 Endkappen und 4 Abdeckstopfen

Fassaden- / Rahmenmontage

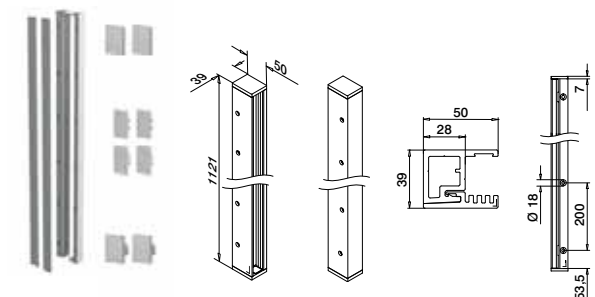

MOD 6839

Aluminium Roh

166839-011-01-00 459 - 465 L = 2x 1,1 m

Aluminium Gebürstet

OUTDOOR

166839-011-01-18 459 - 465 L = 2x 1,1 m



Q-INFO

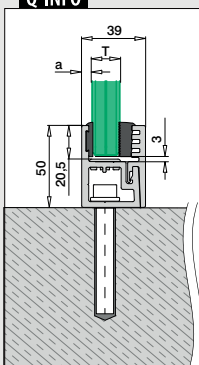

Für monolithisches Glas		T	a
20683x-xxx-12		12	10,5
20683x-xxx-15		15	10,5
20683x-xxx-19		19	6,5
Für laminiertes Glas		T	a
20683x-xxx-13		12,76	10,5
20683x-xxx-14		13,52	10,5
20683x-xxx-17		16,76	6,5
20683x-xxx-18		17,52	6,5
20683x-xxx-21		20,76	6,5
20683x-xxx-22		21,52	6,5

Q-INFO

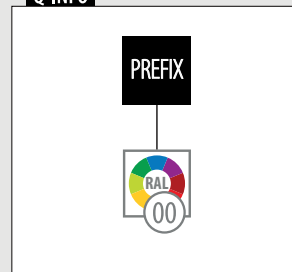



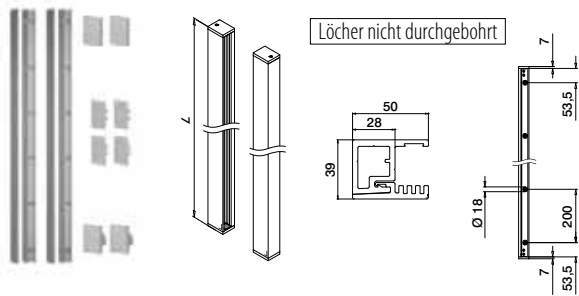

Profilssets zur Wandmontage

Inklusive: 2 Profile für 1100 mm hohes Glas, 4 Endkappen und 4 Abdeckstopfen



**MOD 6839**

<b>Aluminium</b>	Roh		
166839-011-00-00		459 - 465	L = 2x 1,1 m
<b>Aluminium</b>	Gebürstet		
<b>OUTDOOR</b>			
166839-011-00-18		459 - 465	L = 2x 1,1 m
<b>Aluminium</b>	Anthrazitgrau RAL 7016		
<b>OUTDOOR</b>			
<b>NEW</b>	166839-011-00-33	459 - 465	L = 2x 1,1 m
<b>Aluminium</b>	Black Line		
<b>OUTDOOR</b>			
<b>NEW</b>	166839-011-00-82	459 - 465	L = 2x 1,1 m



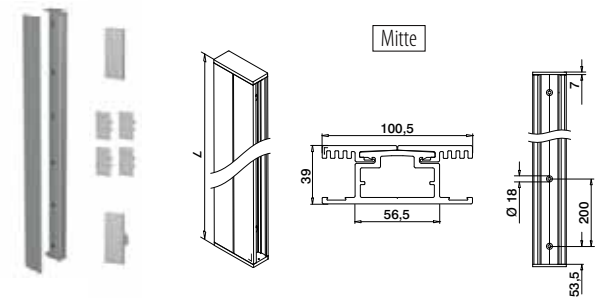

Internationaler Geschmacksmusterschutz

Inklusive: 1 Profil für 1100 mm hohes Glas, 2 Endkappen und 4 Abdeckstopfen



**MOD 6849**

<b>Aluminium</b>	Roh		
166849-011-00-00		459 - 465	L = 1,1 m
<b>Aluminium</b>	Gebürstet		
<b>OUTDOOR</b>			
166849-011-00-18		459 - 465	L = 1,1 m
<b>Aluminium</b>	Anthrazitgrau RAL 7016		
<b>OUTDOOR</b>			
<b>NEW</b>	166849-011-00-33	459 - 465	L = 1,1 m
<b>Aluminium</b>	Black Line		
<b>OUTDOOR</b>			
<b>NEW</b>	166849-011-00-82	459 - 465	L = 1,1 m



**Q-INFO Aluminium**

<b>00</b>	<b>18</b>	<b>33 RAL 7016</b>	<b>82 RAL 9005</b>
			
Roh	Gebürstet, anodisiert	Anthrazitgrau, matt, glatt	Schwarz, matt, strukturiert Pulverbeschichtet

**Q-INFO**

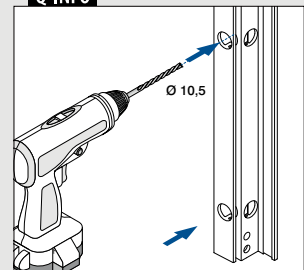



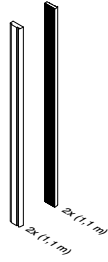

Kombinierbar mit  
MOD 6839 und MOD 6849

**MOD 6831****Zubehör**

Für monolithisches Glas	T	
206831-211-12	12	L = 2x 1,1 m
206831-211-15	15	L = 2x 1,1 m
206831-211-19	19	L = 2x 1,1 m

**Für laminiertes Glas**

206831-211-13	12,76	L = 2x 1,1 m
206831-211-14	13,52	L = 2x 1,1 m
206831-211-17	16,76	L = 2x 1,1 m
206831-211-18	17,52	L = 2x 1,1 m
206831-211-21	20,76	L = 2x 1,1 m
206831-211-22	21,52	L = 2x 1,1 m

**NEW**

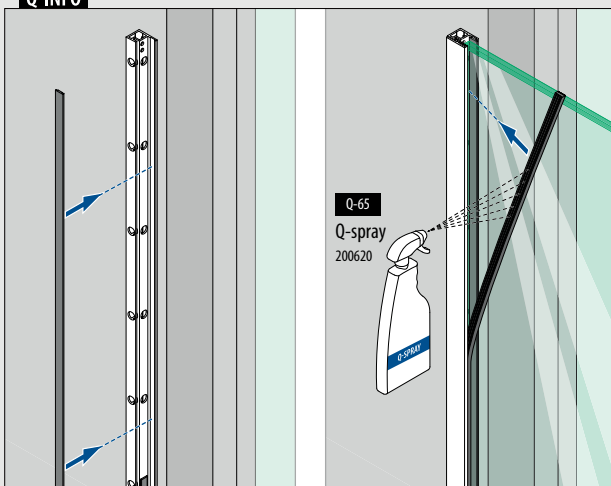
**Q-INFO**

Profile zur Wandmontage

Löcher nicht durchgebohrt

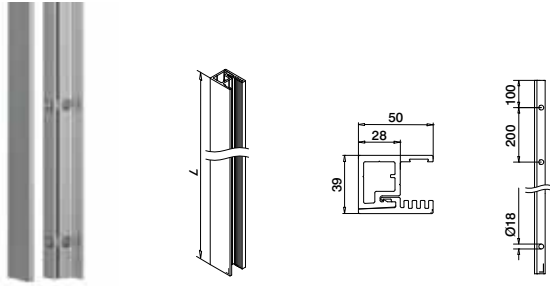

MOD 6830

<b>Aluminium</b> Roh		
166830-050-00-00	459 - 465	L = 5 m
<b>Aluminium</b> Gebürstet		
<b>OUTDOOR</b>		
166830-050-00-18	459 - 465	L = 5 m



Internationaler Geschmacksterschutz

Profile zur Wandmontage

Vorgebohrt

Montage in der Fensterlaibung

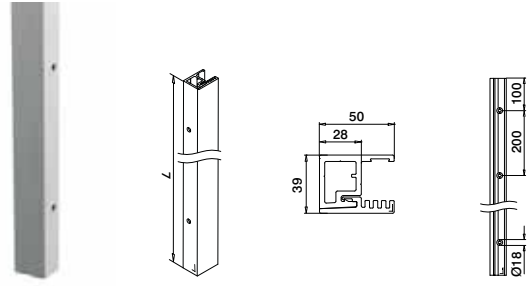

MOD 6830

<b>Aluminium</b> Roh		
166830-050-02-00	459 - 465	L = 5 m
<b>Aluminium</b> Gebürstet		
<b>OUTDOOR</b>		
166830-050-02-18	459 - 465	L = 5 m



Fassaden- / Rahmenmontage

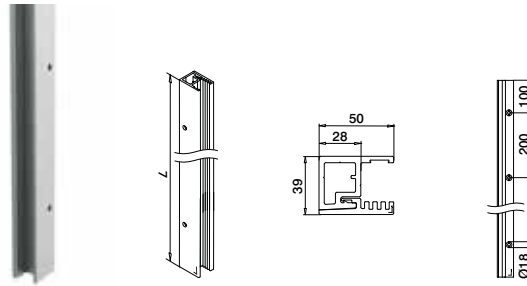

MOD 6830

<b>Aluminium</b> Roh		
166830-050-01-00	459 - 465	L = 5 m
<b>Aluminium</b> Gebürstet		
<b>OUTDOOR</b>		
166830-050-01-18	459 - 465	L = 5 m



Mitte

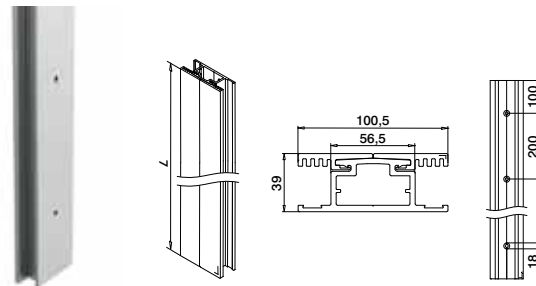

MOD 6840

<b>Aluminium</b> Roh		
166840-050-00-00	459 - 465	L = 5 m
<b>Aluminium</b> Gebürstet		
<b>OUTDOOR</b>		
166840-050-00-18	459 - 465	L = 5 m



Q-INFO

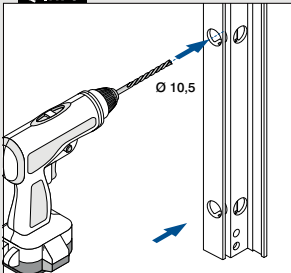

Q-INFO

Aluminium

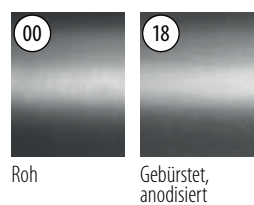

Roh

Gebürstet, anodisiert

Q-INFO

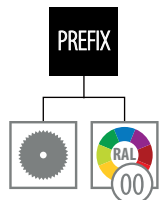

Q-INFO

MOD 6830-050-00

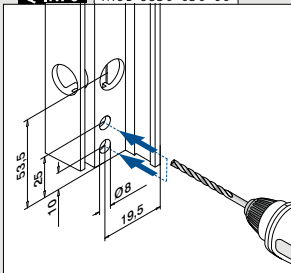

Q-INFO

MOD 6830-050-01

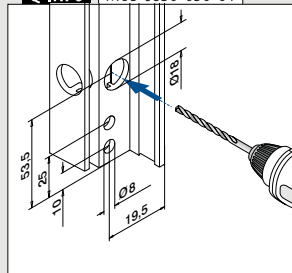

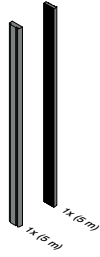

Kombinierbar mit  
MOD 6839 und MOD 6849

**MOD 6831****Zubehör**

Für monolithisches Glas	T	
206831-050-12	12	L = 5 m
206831-050-15	15	L = 5 m
206831-050-19	19	L = 5 m

**Für laminiertes Glas**

206831-050-13	12,76	L = 5 m
206831-050-14	13,52	L = 5 m
206831-050-17	16,76	L = 5 m
206831-050-18	17,52	L = 5 m
206831-050-21	20,76	L = 5 m
206831-050-22	21,52	L = 5 m

**NEW**

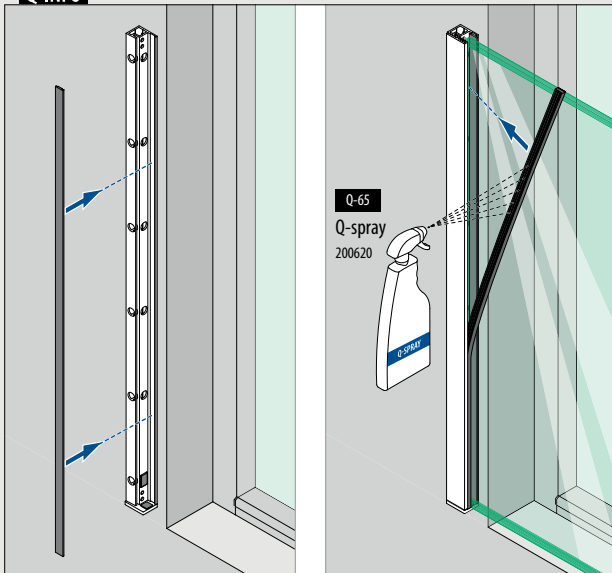
**Q-INFO**

Endkappen für MOD 6830 / 6839

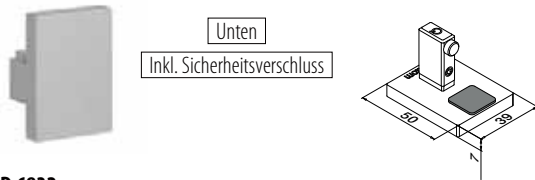

**MOD 6832**

<b>Aluminium</b> Roh	
166832-01-00	2
<b>Aluminium</b> Gebürstet	
<b>OUTDOOR</b>	
166832-01-18	2



Internationaler Geschmacksmusterschutz

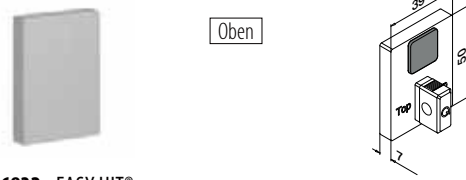

**MOD 6832 - EASY HIT®**

<b>Aluminium</b> Roh	
166832-02-00	2
<b>Aluminium</b> Gebürstet	
<b>OUTDOOR</b>	
166832-02-18	2



Internationaler Geschmacksmusterschutz

Endkappen für MOD 6840 / 6849

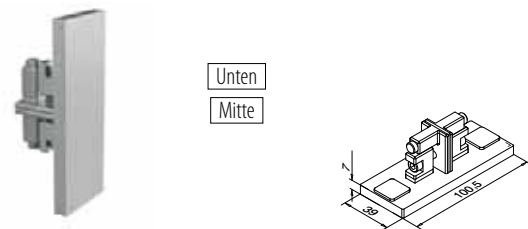

**MOD 6842**

<b>Aluminium</b> Roh	
166842-01-00	2
<b>Aluminium</b> Gebürstet	
<b>OUTDOOR</b>	
166842-01-18	2



Internationaler Geschmacksmusterschutz

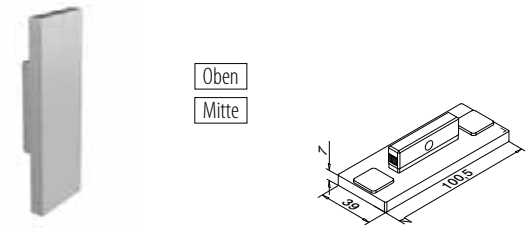

**MOD 6842 - EASY HIT®**

<b>Aluminium</b> Roh	
166842-02-00	2
<b>Aluminium</b> Gebürstet	
<b>OUTDOOR</b>	
166842-02-18	2



Internationaler Geschmacksmusterschutz

Abdeckstopfen

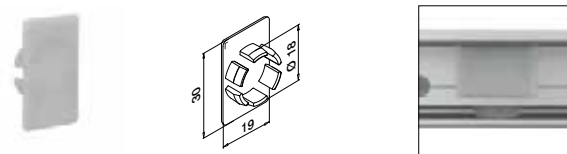

**MOD 6838**

<b>Kunststoff</b> Aluminium RAL 9006	
<b>OUTDOOR</b>	
156838-36	4

**Q-INFO Aluminium**

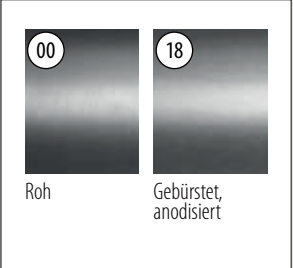

**Q-INFO MOD 6832-01**

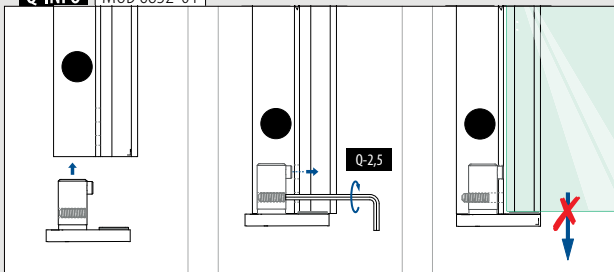

**Q-INFO MOD 6842-01**

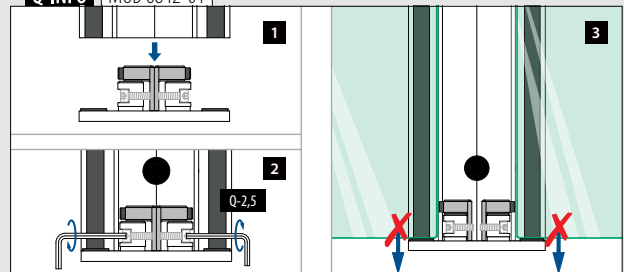





**Beanspruchung:** Leicht und mittel  
**Verwendung:** Innen- und Außenbereich  
**Montage:** Wandmontage (Fassade)  
**Anwendung:** Französische Balkone  
**Material:** Aluminium (gebürstet anodisiert und roh) und gebürsteter Edelstahl V4A  
**Glasstärke:** 8 bis 21,52 mm

Finden Sie alle Informationen zu Easy Glass MOD 6507-6508 online:



<https://q-ne.ws/6507-6508-23>

# EASY GLASS® MOD 6507-6508



## Elegante französische Balkone mit zahlreichen Möglichkeiten

Die französischen Balkone Easy Glass® MOD 6507-6508 schaffen einen minimalistischen, dennoch sicheren Fallschutz an bodentiefen Fenstern. Die Glasfüllung wird mithilfe der Wandflansche und Glasleistenrohre problemlos an der Fassade montiert. Dabei können Sie aus runden oder rechteckigen Geländer-Komponenten auswählen.

Easy Glass® MOD 6507-6508	DE
Max. Holmlast (kN/m)	1,0
Max. Breite (Meter)	2,5



Bitte beachten Sie die Spezifikationen wie Befestigungs- und Glasmaße sowie Glastypeen der jeweiligen Zertifikate.

International getestet/berechnet/zertifiziert:



- 1 Bringen Sie die Glasleistenrohre entweder waagrecht oder senkrecht an der Fassade an.
- 2 Easy Glass MOD 6507-6508 ist eine stilvolle Erweiterung für nahezu jede Fassade.



## EASY GLASS® MOD 6507-6508 VARIANTEN

- Wandmontage mit Verbundankern
- Horizontale sowie vertikale Befestigung möglich

Fassadenmontage  
rund

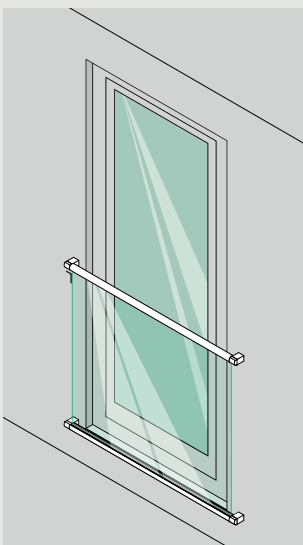

Fassadenmontage  
quadratisch

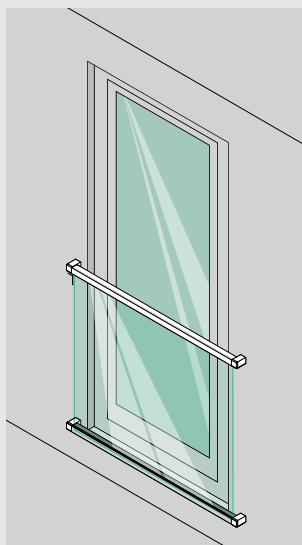

Glasleistenrohre

Easy Glass® MOD 6507

Fassadenmontage

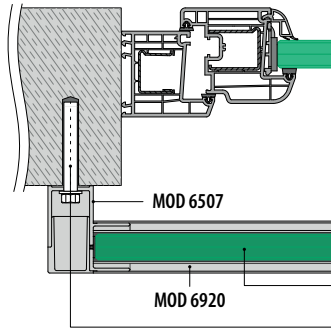

Rahmenmontage

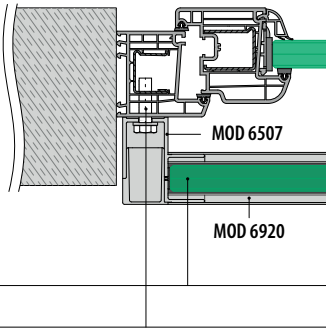

Bitte beachten Sie die Spezifikationen wie Befestigungs- und Glasmaße sowie Glastypen der jeweiligen Zertifikate und statischen Berechnungen.

VSG aus ESG: 160 - 161

Anker: 459 - 465

Glasleistenrohre

Wandflansche

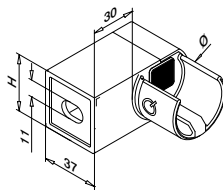

MOD 6507

V4A	316	Gebürstet				
	OUTDOOR	Für Ø	H			
SELL OUT	146507-042-01	42,4	37	459 - 465	2	



Internationaler Geschmacksmusterschutz

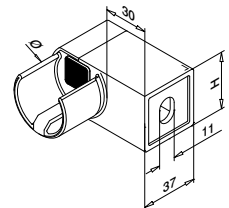

MOD 6507

V4A	316	Gebürstet				
	OUTDOOR	Für Ø	H			
SELL OUT	146507-042-02	42,4	37	459 - 465	2	



Internationaler Geschmacksmusterschutz

Glasleistenrohre

Glasleistenrohre

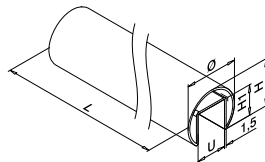

MOD 6920

V4A	316	Gebürstet				
	OUTDOOR	U	Ø	H	H1	
	146920-042-50-12	24	42,4	37	24	L = 5 m



Glasleistenrohre

Gummieinlagen

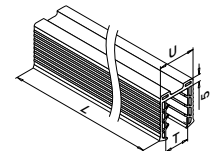

MOD 5124

Zubehör

U = 24 mm		
Für monolithisches Glas	T	
205124-050-08	8 - 10	L = 5 m
205124-050-11	12	L = 5 m
205124-050-15	15	L = 5 m
205124-050-19	19	L = 5 m

Für laminiertes Glas

205124-050-08	8,76 - 10,76	L = 5 m
205124-050-11	11,52 - 13,52	L = 5 m
205124-050-17	16,76 - 17,52	L = 5 m
NEW 205124-050-92	20,76 - 21,52	L = 5 m

Q-INFO

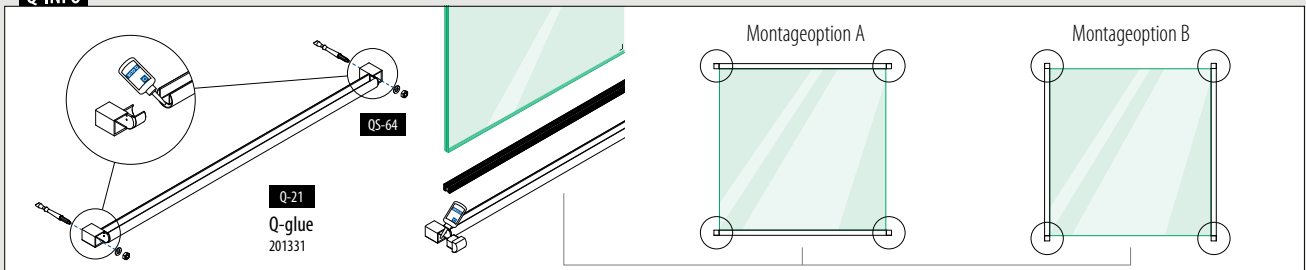

Wandflansche

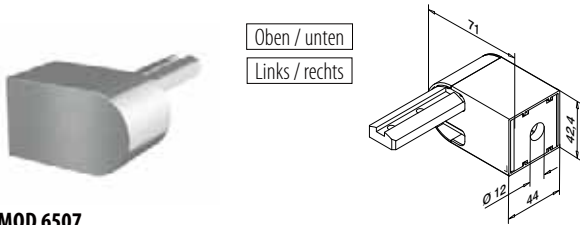

MOD 6507

Aluminium Roh			
166507-042-00-00	42,4	459 - 465	2
Aluminium Gebürstet			
<b>OUTDOOR</b>			
166507-042-00-18	42,4	459 - 465	2

NEW

Glasleistenrohre

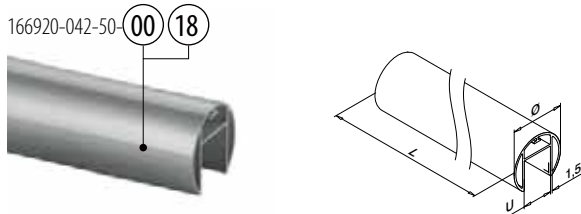

MOD 6920

Aluminium Roh		U	Ø	
166920-042-50-00	24	42,4	L = 5 m	
Aluminium Gebürstet				
<b>OUTDOOR</b>				
166920-042-50-18	24	42,4	L = 5 m	



Internationaler Geschmacksmusterschutz

Gummieinlagen



MOD 5124

Zubehör

U = 24 mm

Für monolithisches Glas	T	
205124-050-08	8 - 10	L = 5 m
205124-050-11	12	L = 5 m
205124-050-15	15	L = 5 m
205124-050-19	19	L = 5 m

Für laminiertes Glas

205124-050-08	8,76 - 10,76	L = 5 m
205124-050-11	11,52 - 13,52	L = 5 m
205124-050-17	16,76 - 17,52	L = 5 m
NEW 205124-050-92	20,76 - 21,52	L = 5 m

Q-INFO MOD 6920

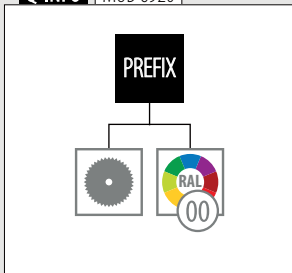

Q-INFO Aluminium



Q-INFO

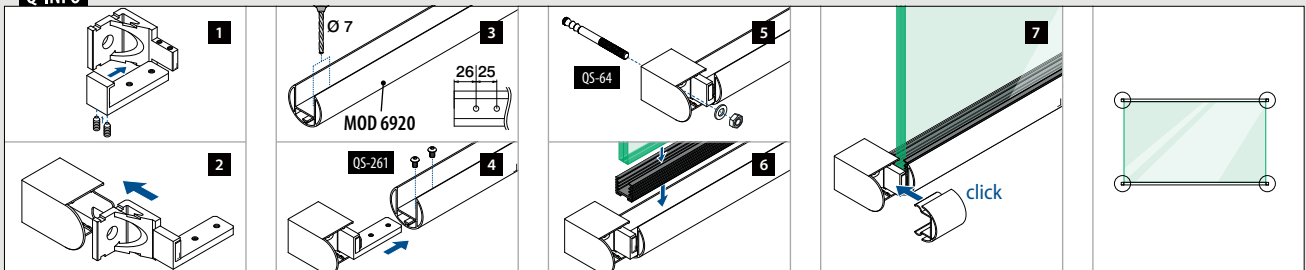



Glasleistenrohre

Easy Glass® MOD 6508

Fassadenmontage

Rahmenmontage

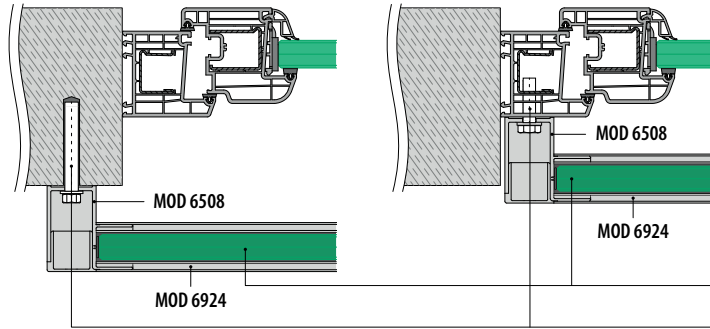

Bitte beachten Sie die Spezifikationen wie Befestigungs- und Glasmaße sowie Glasstypen der jeweiligen Zertifikate und statischen Berechnungen.

VSG aus ESG: 160 - 161

Anker: 459 - 465

Glasleistenrohre

Wandflansche

Quadratisch □

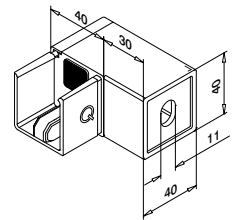
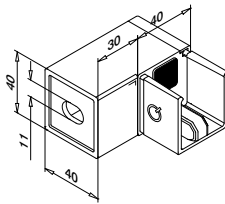

MOD 6508

V4A	316	Gebürstet		
<b>OUTDOOR</b>		□		
146508-040-01	40 x 40	459 - 465	2	



Internationaler Geschmacksmusterschutz

MOD 6508

V4A	316	Gebürstet		
<b>OUTDOOR</b>		□		
146508-040-02	40 x 40	459 - 465	2	



Internationaler Geschmacksmusterschutz

Glasleistenrohre

Glasleistenrohre

Quadratisch □

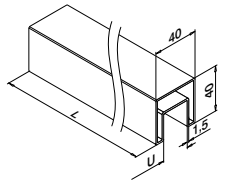

MOD 6924

V4A	316	Gebürstet		
<b>OUTDOOR</b>		U	□	
146924-040-50-12	24	40 x 40	L = 5 m	



Glasleistenrohre

Gummieinlagen

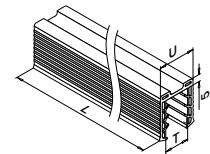

MOD 5124

Zubehör

U = 24 mm			
Für monolithisches Glas		T	
205124-050-08	8 - 10	L = 5 m	
205124-050-11	12	L = 5 m	
205124-050-15	15	L = 5 m	
205124-050-19	19	L = 5 m	

Für laminiertes Glas

205124-050-08	8,76 - 10,76	L = 5 m
205124-050-11	11,52 - 13,52	L = 5 m
205124-050-17	16,76 - 17,52	L = 5 m
<b>NEW</b> 205124-050-92	20,76 - 21,52	L = 5 m

Q-INFO

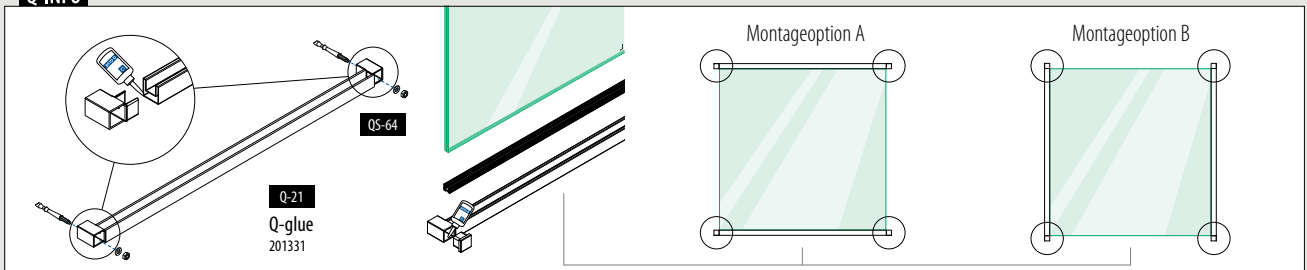

Wandflansche

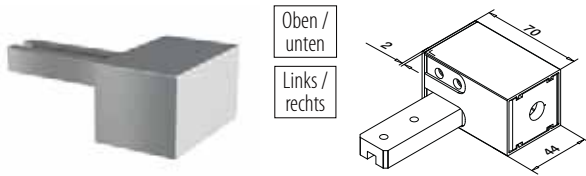

MOD 6508

<b>Aluminium</b>	Gebürstet		
<b>OUTDOOR</b>			
166508-040-18	40 x 40	459 - 465	2

NEW

Glasleistenrohre

Quadratisch

166924-040-50-00 18

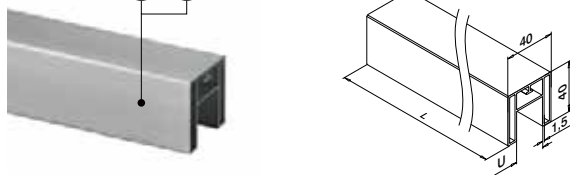

MOD 6924

<b>Aluminium</b>	Roh		
	<b>U</b>	<input type="checkbox"/>	
166924-040-50-00	24	40 x 40	L = 5 m
<b>Aluminium</b>	Gebürstet		
<b>OUTDOOR</b>			
166924-040-50-18	24	40 x 40	L = 5 m



Internationaler Geschmacksmusterschutz

Gummieinlagen



MOD 5124

<b>Zubehör</b>		
U = 24 mm		
Für monolithisches Glas	<b>T</b>	
205124-050-08	8 - 10	L = 5 m
205124-050-11	12	L = 5 m
205124-050-15	15	L = 5 m
205124-050-19	19	L = 5 m

Für laminiertes Glas

205124-050-08	8,76 - 10,76	L = 5 m
205124-050-11	11,52 - 13,52	L = 5 m
205124-050-17	16,76 - 17,52	L = 5 m
NEW 205124-050-92	20,76 - 21,52	L = 5 m

Q-INFO MOD 6924

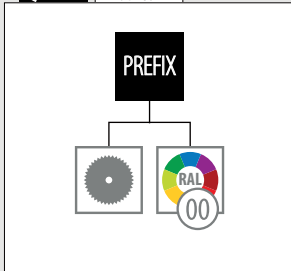

Q-INFO Aluminium

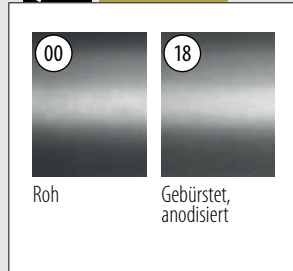

Q-INFO

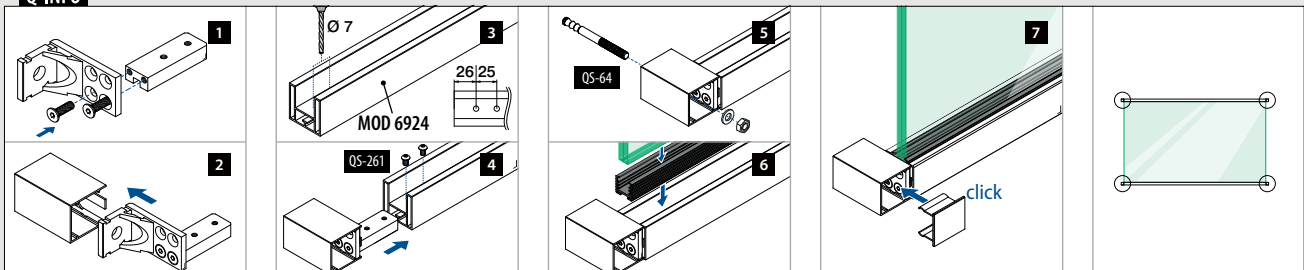

Glasleistenrohre

Easy Glass® MOD 6508

Fassadenmontage

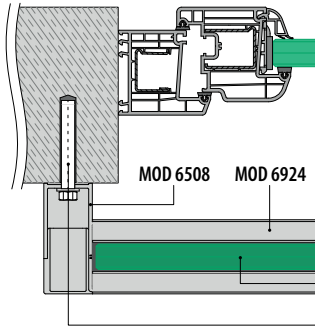

Rahmenmontage

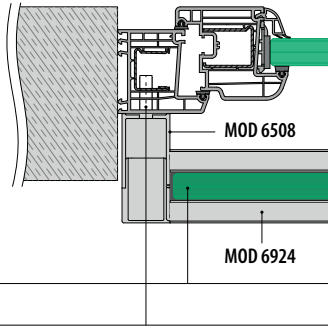

Bitte beachten Sie die Spezifikationen wie Befestigungs- und Glasmaße sowie Glasstypen der jeweiligen Zertifikate und statischen Berechnungen.

VSG aus ESG: 160 - 161

Anker: 459 - 465

Glasleistenrohre

Wandflansche

Rechteckig

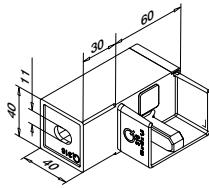

MOD 6508

V4A	316	Gebürstet		
OUTDOOR		<input type="checkbox"/>		
146508-640-01	60 x 40	459 - 465	2	

NEW

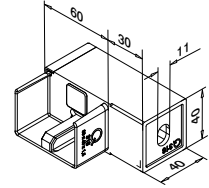

MOD 6508

V4A	316	Gebürstet		
OUTDOOR		<input type="checkbox"/>		
146508-640-02	60 x 40	459 - 465	2	

NEW

Glasleistenrohre

Glasleistenrohre

Rechteckig

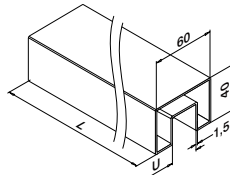

MOD 6924

V4A	316	Gebürstet		
OUTDOOR		<input type="checkbox"/>		
146924-640-50-12	24	60 x 40	L = 5 m	

PREFIX



Glasleistenrohre

Gummieinlagen

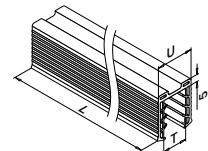

MOD 5124

Zubehör

U = 24 mm		
Für monolithisches Glas		
T		
205124-050-08	8 - 10	L = 5 m
205124-050-11	12	L = 5 m
205124-050-15	15	L = 5 m
205124-050-19	19	L = 5 m

Für laminiertes Glas

205124-050-08	8,76 - 10,76	L = 5 m
205124-050-11	11,52 - 13,52	L = 5 m
205124-050-17	16,76 - 17,52	L = 5 m
NEW 205124-050-92	20,76 - 21,52	L = 5 m

Q-INFO

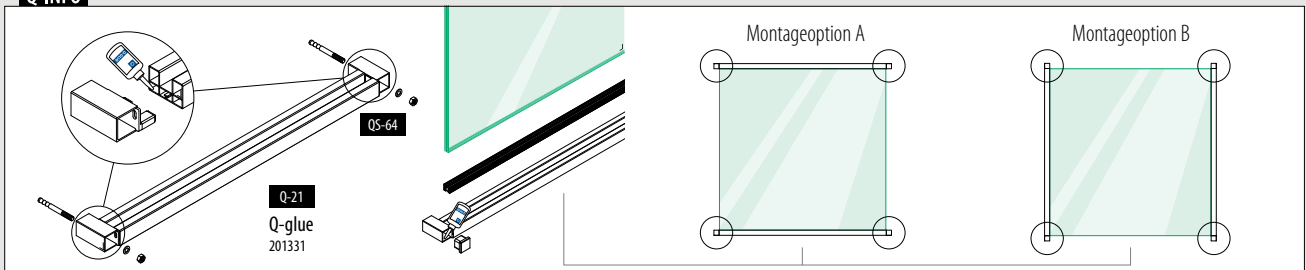

Easy Glass® MOD 6505

Montage in der Fensterlaibung

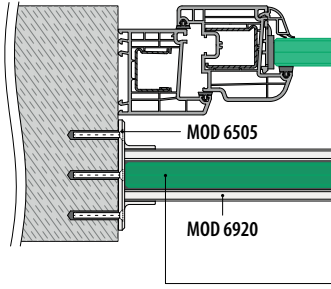

Bitte beachten Sie die Spezifikationen wie Befestigungs- und Glasmaße sowie Glastypen der jeweiligen Zertifikate und statischen Berechnungen.

VSG aus ESG: 160 - 161

Wandflansche

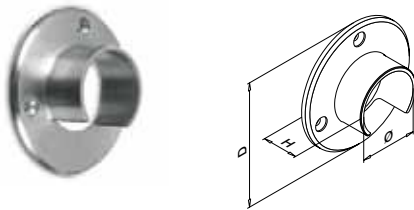

MOD 6505

V4A	316	Gebürstet				
	<b>OUTDOOR</b>	Ø	D	H		
	146505-042-12	42,4	90	30	QS-6  473	2



Glasleistenrohre

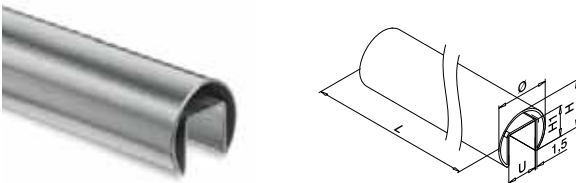

MOD 6920

V4A	316	Gebürstet				
	<b>OUTDOOR</b>	U	Ø	H	H1	
	146920-042-50-12	24	42,4	37	24	L = 5 m



Gummieinlagen



MOD 5124

Zubehör

U = 24 mm

Für monolithisches Glas	T	
205124-050-08	8 - 10	L = 5 m
205124-050-11	12	L = 5 m
205124-050-15	15	L = 5 m
205124-050-19	19	L = 5 m
205124-250-08	8 - 10	L = 25 m
205124-250-11	12	L = 25 m
<b>SELL OUT</b> 205124-250-15	15	L = 25 m
<b>SELL OUT</b> 205124-250-19	19	L = 25 m

Für laminiertes Glas

205124-050-08	8,76 - 10,76	L = 5 m
205124-050-11	11,52 - 13,52	L = 5 m
205124-050-17	16,76 - 17,52	L = 5 m
<b>NEW</b> 205124-050-92	20,76 - 21,52	L = 5 m
205124-250-08	8,76 - 10,76	L = 25 m
205124-250-11	11,52 - 13,52	L = 25 m
205124-250-17	16,76 - 17,52	L = 25 m
<b>NEW</b> 205124-250-92	20,76 - 21,52	L = 25 m

**SELL OUT** Nur solange der Vorrat reicht.

Q-INFO MOD 6920

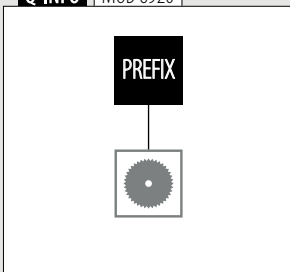



Easy Glass® MOD 6545

Montage in der Fensterlaibung

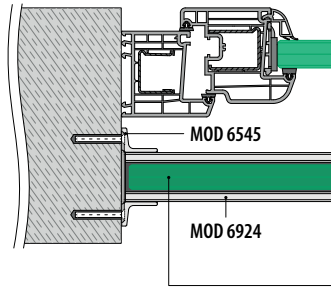

Bitte beachten Sie die Spezifikationen wie Befestigungs- und Glasmaße sowie Glastypen der jeweiligen Zertifikate und statischen Berechnungen.

VSG aus ESG: 160 - 161

Wandflansche

Quadratisch

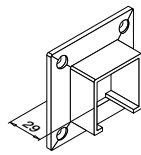
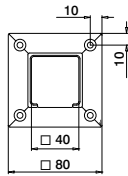

MOD 6545

V4A	316	Gebürstet		
OUTDOOR		<input type="checkbox"/>		
146545-040-12	40 x 40	QS-50	473	2



Glasleistenrohre

Quadratisch

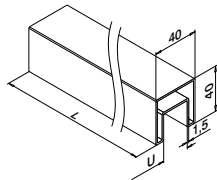

MOD 6924

V4A	316	Gebürstet		
OUTDOOR		<input type="checkbox"/>		
146924-040-50-12	24	40 x 40		L = 5 m

PREFIX



Gummieinlagen

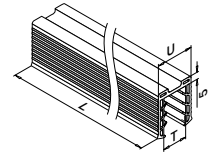

MOD 5124

Zubehör		
U = 24 mm		
Für monolithisches Glas	T	
205124-050-08	8 - 10	L = 5 m
205124-050-11	12	L = 5 m
205124-050-15	15	L = 5 m
205124-050-19	19	L = 5 m

Für laminiertes Glas		
205124-050-08	8,76 - 10,76	L = 5 m
205124-050-11	11,52 - 13,52	L = 5 m
205124-050-17	16,76 - 17,52	L = 5 m
<b>NEW</b> 205124-050-92	20,76 - 21,52	L = 5 m

Q-INFO | MOD 6924

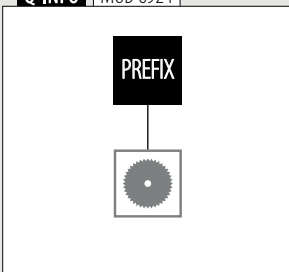

Easy Glass® MOD 6545

Montage in der Fensterlaibung

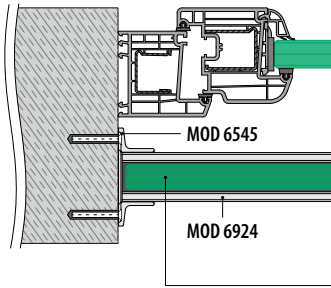

Bitte beachten Sie die Spezifikationen wie Befestigungs- und Glasmaße sowie Glastypen der jeweiligen Zertifikate und statischen Berechnungen.

VSG aus ESG: 160 - 161

Wandflansche

Rechteckig

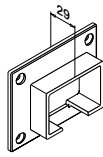
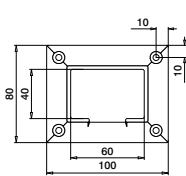

MOD 6545

V4A	316	Gebürstet	<input type="checkbox"/>		
OUTDOOR					
146545-640-12	60 x 40	QS-50 473	2		



Glasleistenrohre

Rechteckig

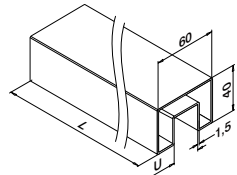

MOD 6924

V4A	316	Gebürstet	<input type="checkbox"/>		
OUTDOOR					
146924-640-50-12	24	60 x 40	L = 5 m		



Q-INFO MOD 6924

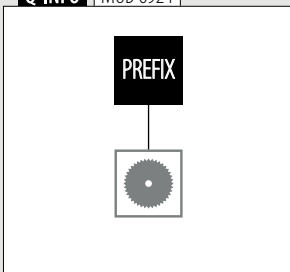

Easy Glass® MOD 6504

Montage in der Fensterlaibung

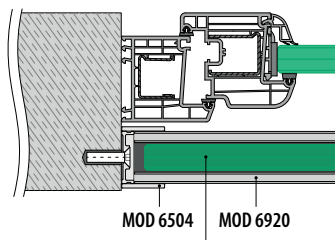

Bitte beachten Sie die Spezifikationen wie Befestigungs- und Glasmaße sowie Glastypen der jeweiligen Zertifikate und statischen Berechnungen.

VSG aus ESG: 160 - 161

Wandflansche

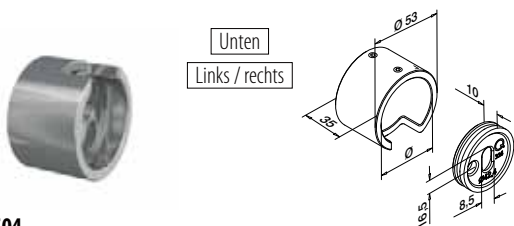

MOD 6504

Aluminium Roh	Ø	
166504-042-00-00	42,4	2
Aluminium Gebürstet		
OUTDOOR		
166504-042-00-18	42,4	2

NEW

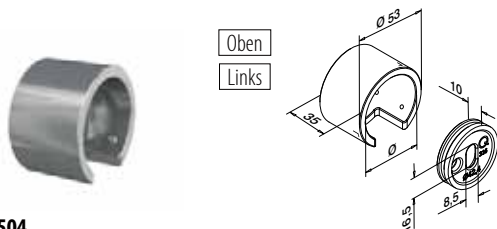

MOD 6504

Aluminium Roh	Ø	
166504-042-01-00	42,4	2
Aluminium Gebürstet		
OUTDOOR		
166504-042-01-18	42,4	2

NEW

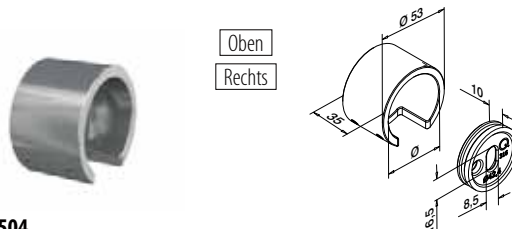

MOD 6504

Aluminium Roh	Ø	
166504-042-02-00	42,4	2
Aluminium Gebürstet		
OUTDOOR		
166504-042-02-18	42,4	2

NEW

Q-INFO Aluminium

00

Roh

18

Gebürstet, anodisiert

**Glasleistenrohre**

166920-042-50-00 18

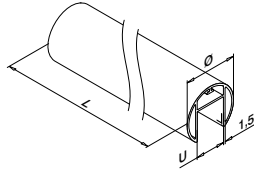

**MOD 6920**

Aluminium Roh	U	Ø	L = 5 m
166920-042-50-00	24	42,4	L = 5 m
Aluminium Gebürstet			
OUTDOOR			
166920-042-50-18	24	42,4	L = 5 m



Internationaler Geschmacksmusterschutz

**Gummieinlagen**

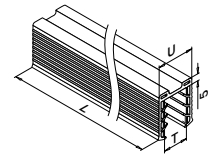

**MOD 5124**

Zubehör	U = 24 mm	T	L = 5 m
Für monolithisches Glas			
205124-050-08	8 - 10	L = 5 m	
205124-050-11	12	L = 5 m	
205124-050-15	15	L = 5 m	
205124-050-19	19	L = 5 m	
205124-250-08	8 - 10	L = 25 m	
205124-250-11	12	L = 25 m	
205124-250-15	15	L = 25 m	
205124-250-19	19	L = 25 m	

Für laminiertes Glas	T	L = 5 m
205124-050-08	8,76 - 10,76	L = 5 m
205124-050-11	11,52 - 13,52	L = 5 m
205124-050-17	16,76 - 17,52	L = 5 m
NEW 205124-050-92	20,76 - 21,52	L = 5 m
205124-250-08	8,76 - 10,76	L = 25 m
205124-250-11	11,52 - 13,52	L = 25 m
205124-250-17	16,76 - 17,52	L = 25 m
NEW 205124-250-92	20,76 - 21,52	L = 25 m

**Q-INFO MOD 6920**

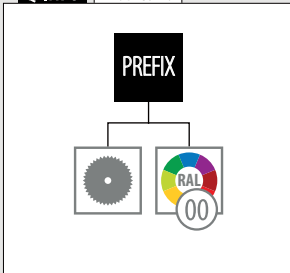

**Q-INFO**

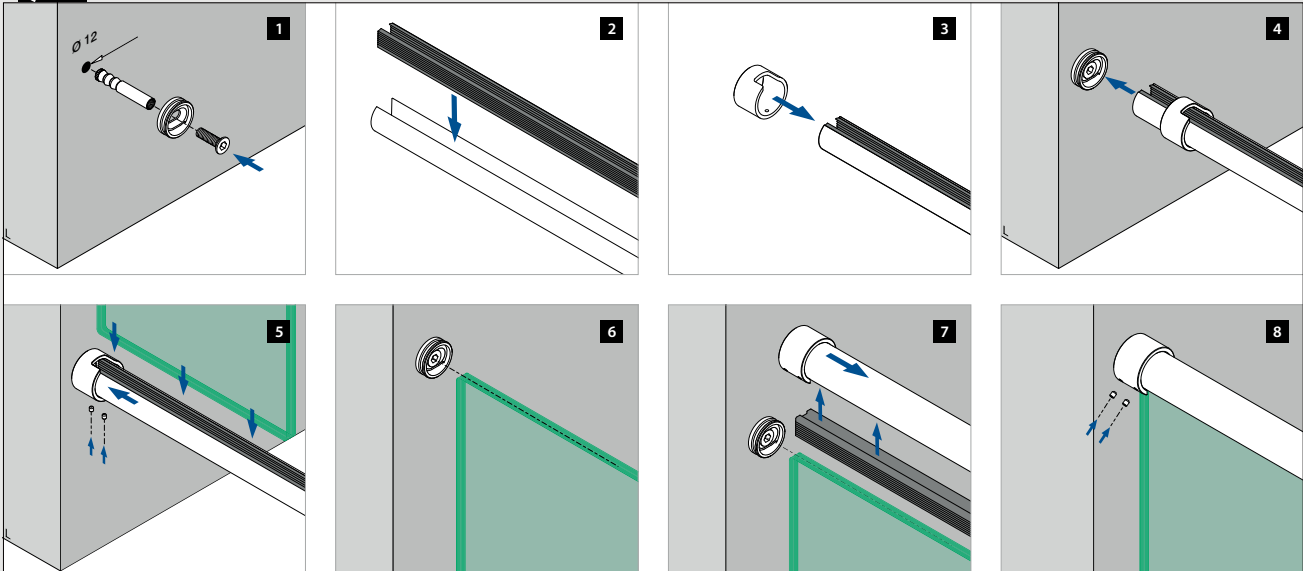





# FRANZÖSISCHE BALKONE MIT GLASKLEMMEN



Glasklemmen - MOD 2300

Montage in der Fensterlaibung

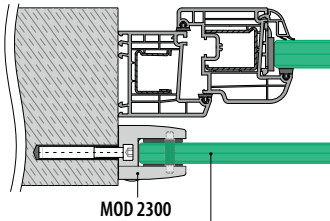

Bitte beachten Sie die Spezifikationen wie Befestigungs- und Glasmaße sowie Glastypen der jeweiligen Zertifikate und statischen Berechnungen.

VSG aus ESG: ■ 160 - 161

Glasklemmen - MOD 2300

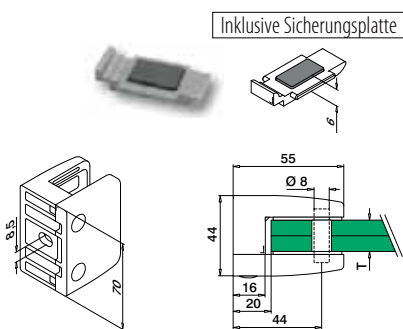

Inklusive Sicherungsplatte

MOD 2300

V4A 316 Gebürstet

OUTDOOR

T



QS-27 ■ 474



4

142300-000-12

Siehe T in MOD 5023



Gummieinlagen für MOD 2300



2 Stück pro Glasklemme

MOD 5023

Zubehör

Für monolithisches Glas

T



NEW  
NEW

205023-12  
205023-15  
205023-19

12  
15  
19

8  
8  
8

Für laminiertes Glas

NEW  
NEW  
NEW  
NEW  
NEW  
NEW

205023-44  
205023-54  
205023-13  
205023-64  
205023-17  
205023-18  
205023-21  
205023-22

9,52  
11,52  
12,76  
13,52  
16,76  
17,52  
20,76  
21,52

8  
8  
8  
8  
8  
8  
8  
8

Sicherungsstifte

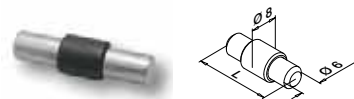

Optional verwendbar für MOD 2300

MOD 5015

Zubehör

L



205015-23

34

4

Q-INFO MOD 2300

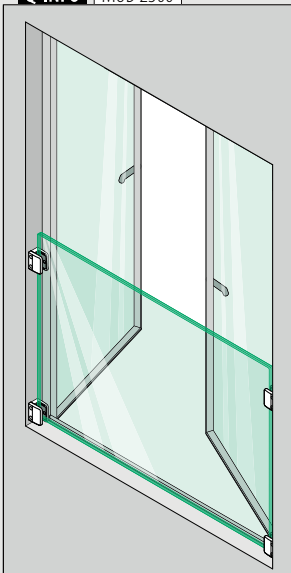

Q-INFO MOD 2300

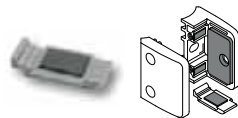

Verwenden Sie die Sicherungsplatte anstelle des Sicherungsstiftes. Das spart Ihnen Zeit und Kosten, weil Löcher im Glas nicht notwendig sind.

Q-INFO MOD 5015

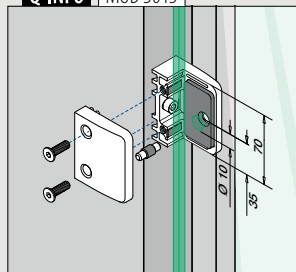

Bitte bestellen Sie Befestigungsmaterial separat.





# FRANZÖSISCHE BALKONE MIT GLASADAPTERN

Fassadenmontage

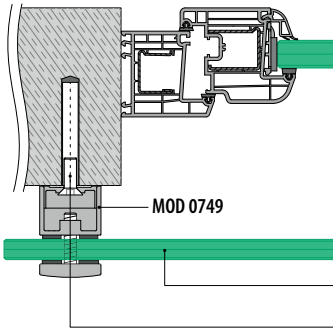

Bitte beachten Sie die Spezifikationen wie Befestigungs- und Glasmaße sowie Glastypen der jeweiligen Zertifikate und statischen Berechnungen.

VSG aus ESG: ■ 160 - 161

Anker: ■ 459 - 465

Punktförmige Glasadapter

Justierbar

Ø 50

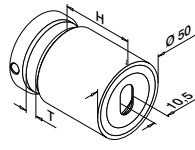

MOD 0749

V4A	316	Gebürstet				
OUTDOOR			H	T		
140749-030-12	30	12 - 25,52	■ 459 - 465	2		
140749-040-12	40	8 - 25,52	■ 459 - 465	2		
140749-050-12	50	8 - 25,52	■ 459 - 465	2		
140749-100-12	100	8 - 25,52	■ 459 - 465	2		

V4A	316	Black Line				
OUTDOOR						
NEW	140749-030-82	30	12 - 25,52	■ 459 - 465	2	
NEW	140749-040-82	40	8 - 25,52	■ 459 - 465	2	
NEW	140749-050-82	50	8 - 25,52	■ 459 - 465	2	



Einlagen für Glasadapter

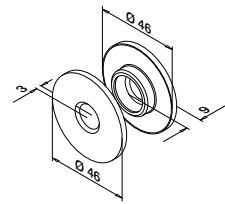

MOD 5030

Zubehör	Für MOD	
205030-150-99-80	0749	4

NEW

Q-INFO

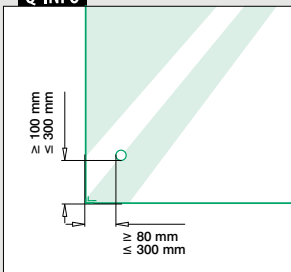

Q-INFO



Q-INFO

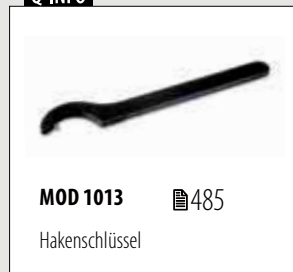



Fassadenmontage

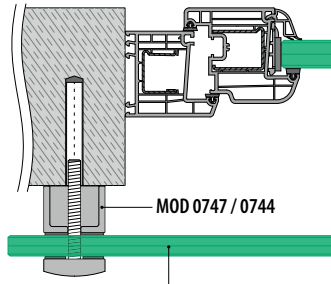

Bitte beachten Sie die Spezifikationen wie Befestigungs- und Glasmaße sowie Glastypen der jeweiligen Zertifikate und statischen Berechnungen.

VSG aus ESG: 160 - 161

Punktförmige Glasadapter

Ø 50

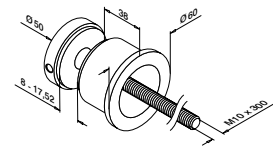
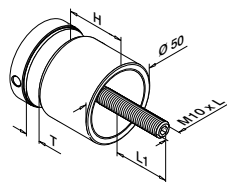

MOD 0747

V4A	316	Gebürstet					
OUTDOOR			H	T	L	L1	
140747-010-12	10	8 - 17,52	50	11 - 20	2		
140747-020-12	20	8 - 25,52	70	13 - 31	2		
140747-030-12	30	8 - 25,52	80	13 - 31	2		
140747-040-12	40	8 - 17,52	80	11 - 21	2		
140747-050-12	50	8 - 17,52	90	11 - 21	2		

MOD 0744

V4A	316	Gebürstet		
OUTDOOR				
140744-12			2	



V4A	316	Black Line				
OUTDOOR						
NEW	140747-010-82	10	8 - 17,52	50	11 - 20	2
NEW	140747-030-82	30	8 - 25,52	80	13 - 31	2

Zinkdruckguss Edelstahl-effekt

SELL OUT	OUTDOOR				
100747-20	10	8 - 17,52	50	11 - 20	2



Q-INFO MOD 0747

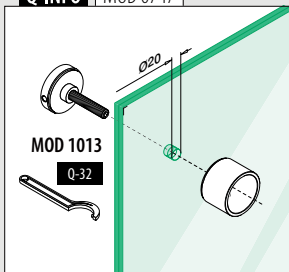

Q-INFO MOD 0747

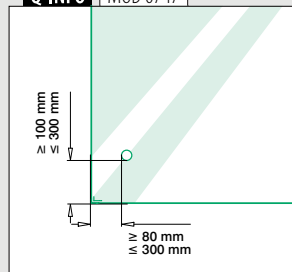

Q-INFO MOD 0744

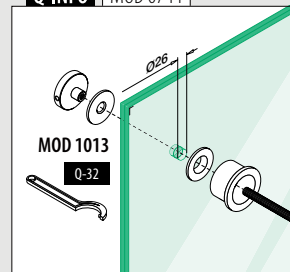

Q-INFO 316

12	82 RAL 9005
Gebürstet	Pulverbeschichtet
	Schwarz, matt, strukturiert

Punktförmige Glasadapter

Ø 60

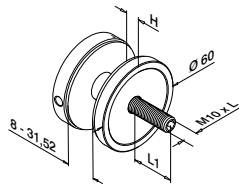

MOD 0745

V4A	316	Gebürstet			
	<b>OUTDOOR</b>		<b>H</b>	<b>L</b>	<b>L1</b>
	140745-010-12		10	70	17 - 41

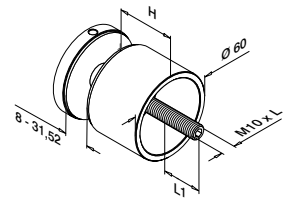

MOD 0745

V4A	316	Gebürstet			
	<b>OUTDOOR</b>		<b>H</b>	<b>L</b>	<b>L1</b>
	140745-030-12		30	90	17 - 41
	140745-050-12		50	110	17 - 41



Punktförmige Glasadapter

Ø 70

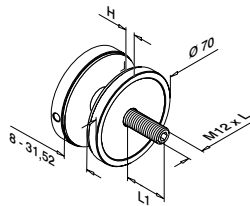

MOD 0748

V4A	316	Gebürstet			
	<b>OUTDOOR</b>		<b>H</b>	<b>L</b>	<b>L1</b>
	140748-010-12		10	70	17 - 41

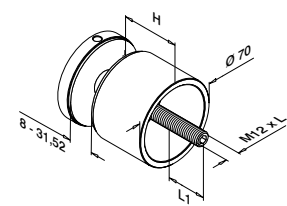

MOD 0748

V4A	316	Gebürstet			
	<b>OUTDOOR</b>		<b>H</b>	<b>L</b>	<b>L1</b>
	140748-030-12		30	90	17 - 41
	140748-040-12		40	100	17 - 41



Q-INFO MOD 0745 / 0748

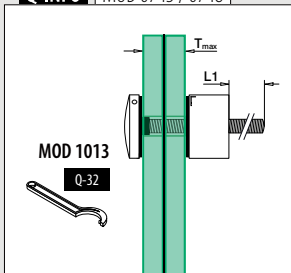

Q-INFO MOD 0745-010

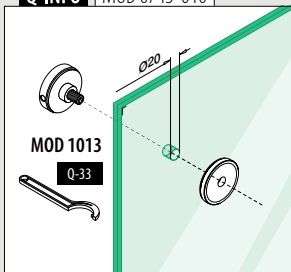

Q-INFO MOD 0745-030 / 050

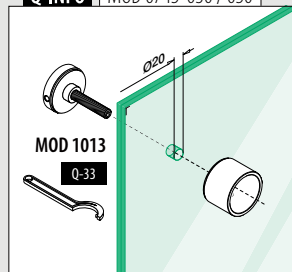

Q-INFO MOD 0748-010

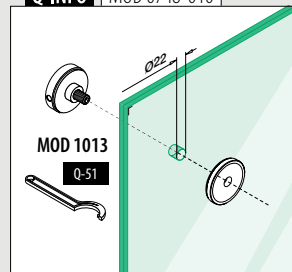

Q-INFO MOD 0748-030 / 040

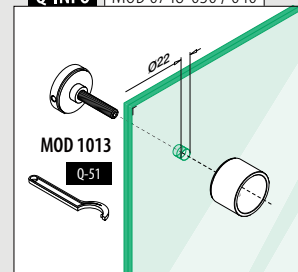

Fassadenmontage

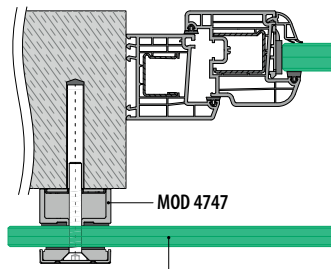

Bitte beachten Sie die Spezifikationen wie Befestigungs- und Glasmaße sowie Glastypen der jeweiligen Zertifikate und statischen Berechnungen.

VSG aus ESG: 160 - 161

Geländerbasis

Punktförmige Glasadapter

Quadratisch □

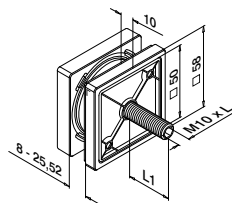

MOD 4747

V4A	316	Gebürstet		
	<b>OUTDOOR</b>	<b>L</b>	<b>L1</b>	
144747-010-12	60	13 - 31	2	



Internationaler Geschmacksmusterschutz

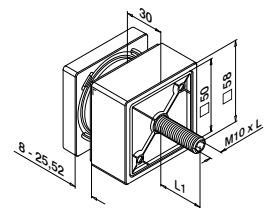

MOD 4747

V4A	316	Gebürstet		
	<b>OUTDOOR</b>	<b>L</b>	<b>L1</b>	
144747-030-12	80	13 - 31	2	



Internationaler Geschmacksmusterschutz

Q-INFO

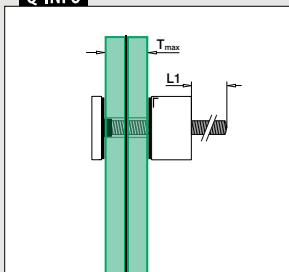

Q-INFO

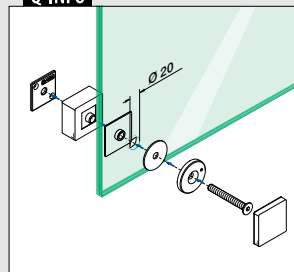

Q-INFO

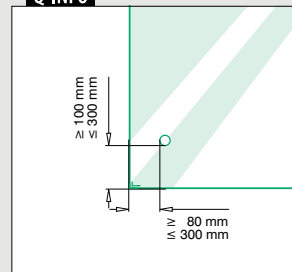

## Fassadenmontage

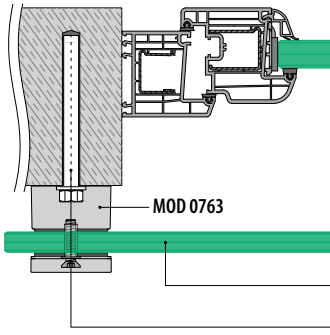



Bitte beachten Sie die Spezifikationen wie Befestigungs- und Glasmaße sowie Glastypen der jeweiligen Zertifikate und statischen Berechnungen.

VSG aus ESG: ■ 160 - 161

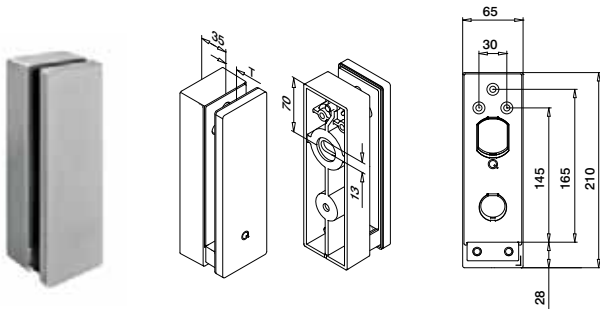
Anker: ■ 459 - 465



## MOD 0763

V4A	316	Gebürstet		
	OUTDOOR	T		
140763-12		12 - 21,52	■ 459 - 465	1



Internationaler Geschmacksmusterschutz

## Q-INFO

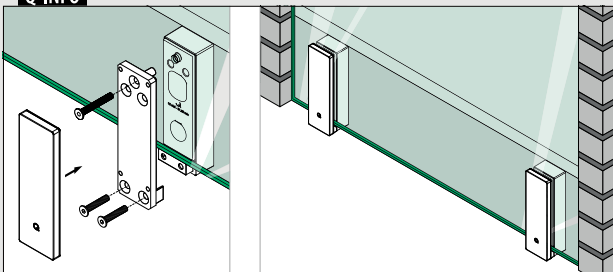

## Q-INFO

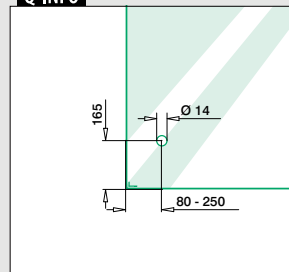





# FENSTERABSTURZ- STANGEN

Absturztangen 20x10 - MOD 4828

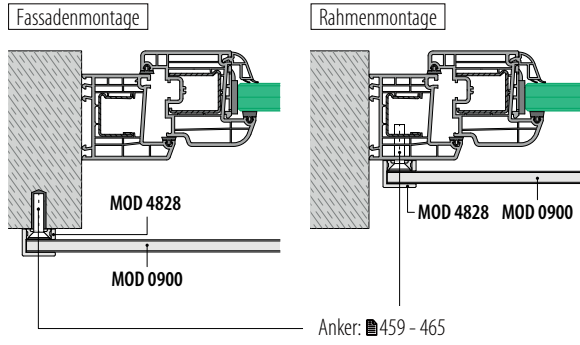

Absturztangen 20x10 - MOD 4827

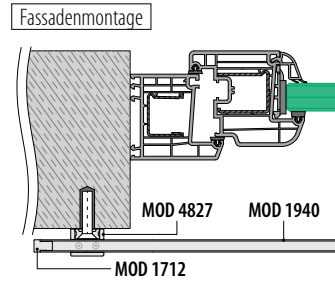

Bitte beachten Sie die Spezifikationen wie zum Beispiel Befestigungsmaße der jeweiligen Zertifikate und statischen Berechnungen.

Querstabhalter

Rechteckig

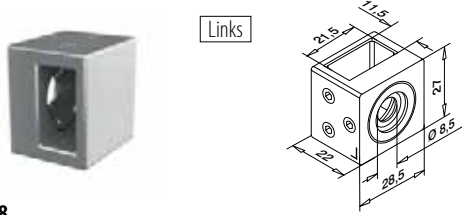

MOD 4828

V4A	316	Gebürstet			
<b>OUTDOOR</b>	<b>Für Rohr</b>	<input type="checkbox"/>			
144828-01-12	20 x 10 x 1,0	QS-20	474	4	

NEW

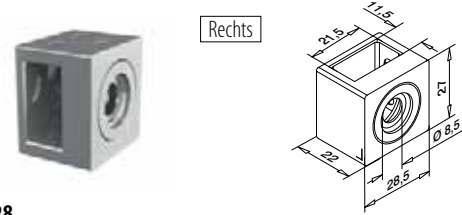

MOD 4828

V4A	316	Gebürstet			
<b>OUTDOOR</b>	<b>Für Rohr</b>	<input type="checkbox"/>			
144828-02-12	20 x 10 x 1,0	QS-20	474	4	

NEW

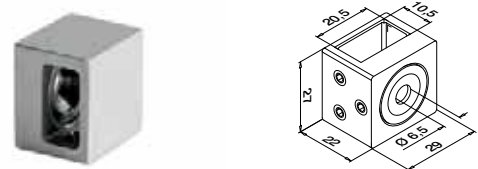

MOD 4827

V4A	316	Gebürstet			
<b>OUTDOOR</b>	<b>Für Rohr</b>	<input type="checkbox"/>			
144827-12	20 x 10 x 1,0	QS-16	474	4	



Internationaler Geschmacksmusterschutz

Endkappen

Rechteckig

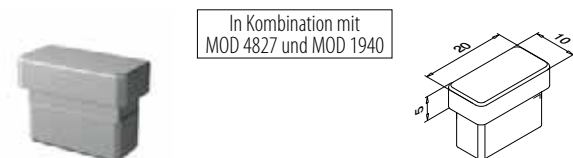

MOD 1712

V4A	316	Gebürstet			
<b>OUTDOOR</b>	<b>Für Rohr</b>	<input type="checkbox"/>			
141712-021-12	20 x 10 x 1,0			4	



Internationaler Geschmacksmusterschutz

Rohre

Q-TUBE

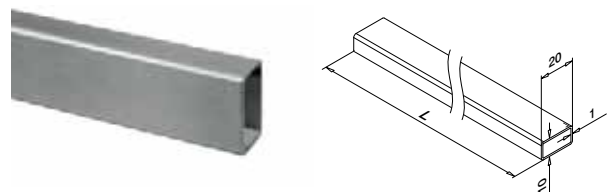

MOD 1940

V4A	316	Gebürstet			
<b>OUTDOOR</b>	<b>Für Rohr</b>	<input type="checkbox"/>			
141940-021-50-12	20 x 10 x 1,0			L = 5 m	



Q-INFO MOD 4828

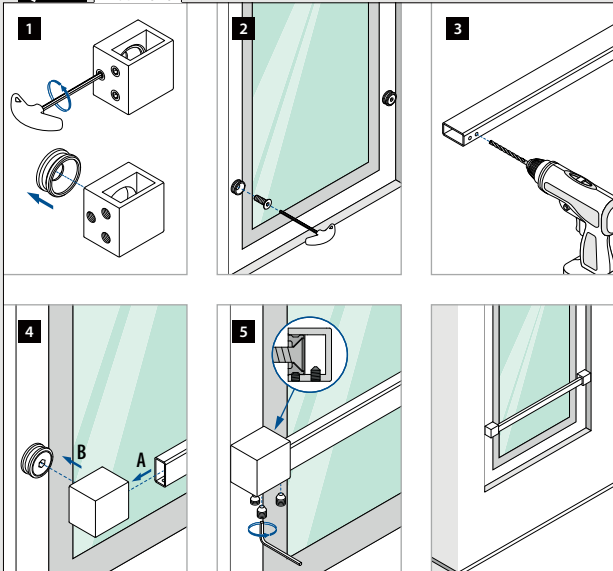

Absturzstangen 40x40 - MOD 6518

Fassadenmontage

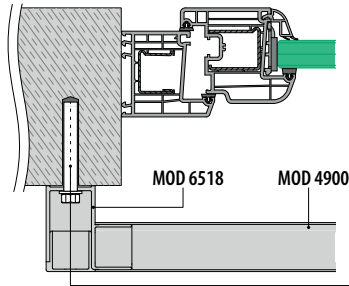

Rahmenmontage

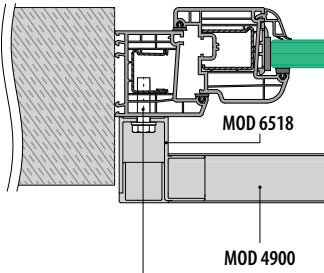

Bitte beachten Sie die Spezifikationen wie zum Beispiel Befestigungsmaße der jeweiligen Zertifikate und statischen Berechnungen.

Anker: ■459 - 465

Wandflansche

Quadratisch □

Links / rechts

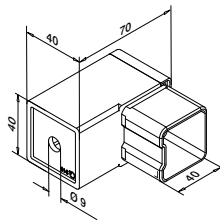

MOD 6518

V4A	316	Gebürstet		
	<b>OUTDOOR</b>	<b>Für Rohr</b> □		
146518-040-12	40 x 40 x 2,0	■459 - 465		2

NEW

Rohre

Q-TUBE

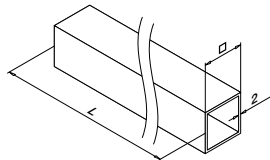

MOD 4900

V4A	316	Gebürstet		
	<b>OUTDOOR</b>	□		
144900-040-50-12	40 x 40 x 2,0	L = 5 m		

PREFIX



Q-INFO

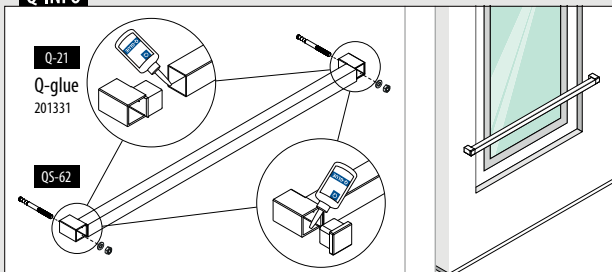

Q-INFO MOD 4900

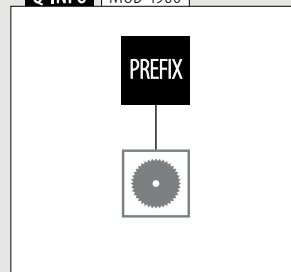

Absturztangen 40x40 - MOD 4507

Fassadenmontage

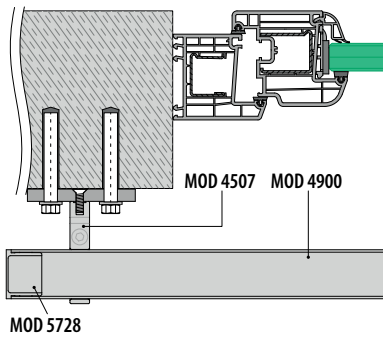

Bitte beachten Sie die Spezifikationen wie zum Beispiel Befestigungsmaße der jeweiligen Zertifikate und statischen Berechnungen.

Absturztangen 40x40 - MOD 4505

Montage in der Fensterlaibung

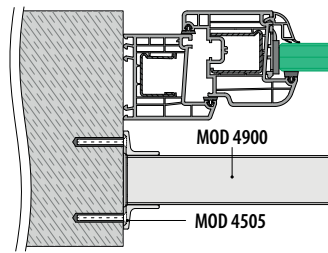

Bitte beachten Sie die Spezifikationen wie zum Beispiel Befestigungsmaße der jeweiligen Zertifikate und statischen Berechnungen.

Rohrhalter

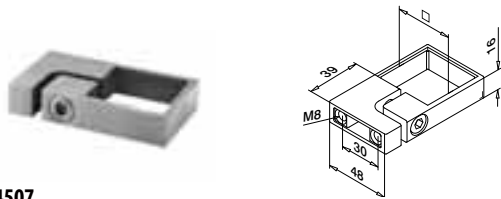

MOD 4507

V4A	316	Gebürstet		
OUTDOOR		<input type="checkbox"/>		
144507-040-12	40 x 40	QS-20	474	2
NEW				

Wandflansche

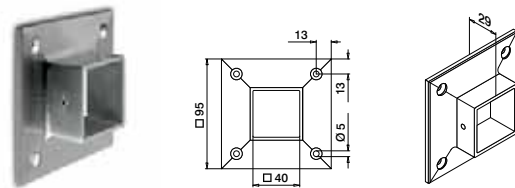

MOD 4505

V4A	316	Gebürstet		
OUTDOOR		<input type="checkbox"/>		
144505-040-12	40 x 40	QS-6	473	2

Rohre

Q-TUBE

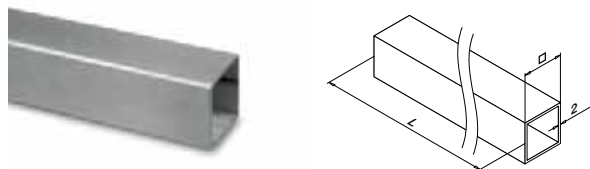

MOD 4900

V4A	316	Gebürstet		
OUTDOOR		<input type="checkbox"/>		
144900-040-50-12	40 x 40 x 2,0			L = 5 m
PREFIX				

Endkappen

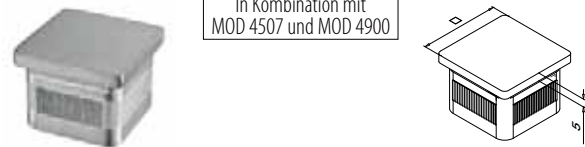

MOD 5728 - EASY HIT®

V4A	316	Gebürstet		
OUTDOOR		<input type="checkbox"/>		
145728-040-12	40 x 40 x 2,0	Für Rohr		2

Q-INFO MOD 4900

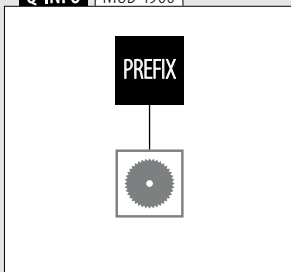



Fassadenmontage

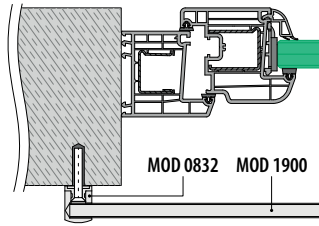

Rahmenmontage

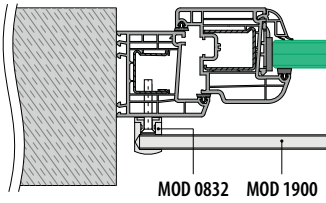

Bitte beachten Sie die Spezifikationen wie zum Beispiel Befestigungsmaße der jeweiligen Zertifikate und statischen Berechnungen.

Füllungen

Stabhalter



Links

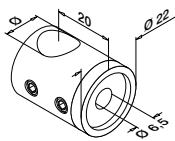

Rechts

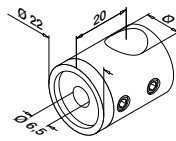

MOD 0832

V4A	316	Gebürstet		
	OUTDOOR	Ø		
140832-000-12	12	QS-16	474	4



MOD 0833

V4A	316	Gebürstet		
	OUTDOOR	Ø		
140833-000-12	12	QS-16	474	4

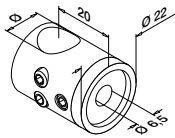

MOD 0831

V4A	316	Gebürstet		
	OUTDOOR	Ø		
140831-000-12	12	QS-16	474	4



Füllungen

Endkappen



In Kombination mit MOD 0831 und MOD 1900

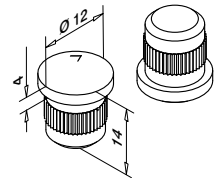

MOD 1759 - EASY HIT®

V4A	316	Gebürstet		
	OUTDOOR			
141759-112-12			4	

NEW

Q-INFO MOD 1759

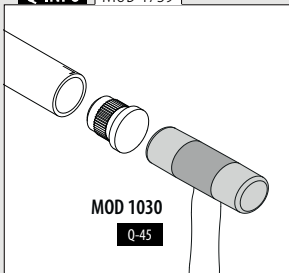

Q-INFO

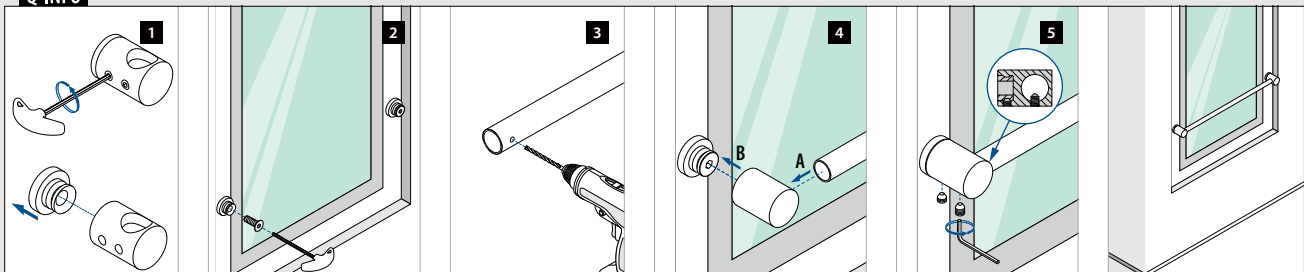

## Absturzstangen Ø12 - MOD 0504

### Montage in der Fensterlaibung

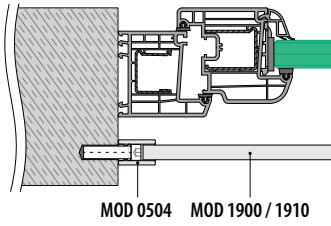

Bitte beachten Sie die Spezifikationen wie zum Beispiel Befestigungsmaße der jeweiligen Zertifikate und statischen Berechnungen.

### Handläufe

## Wandflansche

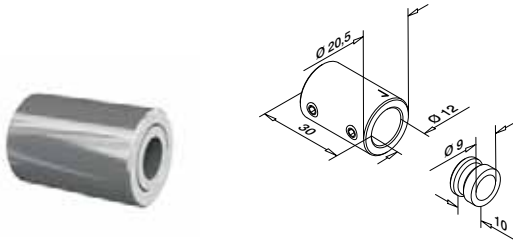

### MOD 0504

V4A	316	Gebürstet		
<b>OUTDOOR</b>				
140504-012-12	QS-27	474		2

NEW

### Füllungen

## Stäbe

## Q-TUBE



### MOD 1910

V4A	316	Gebürstet		
<b>OUTDOOR</b>				
141910-012-25-12	12		L = 2,5 m	
141910-012-50-12	12		L = 5 m	

PREFIX



### Füllungen

## Rohre

## Q-TUBE

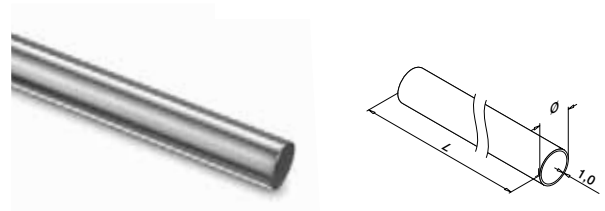

### MOD 1900

V4A	316	Gebürstet		
<b>OUTDOOR</b>				
141900-012-50-12	12		L = 5 m	

NEW

PREFIX



### Q-INFO MOD 0504

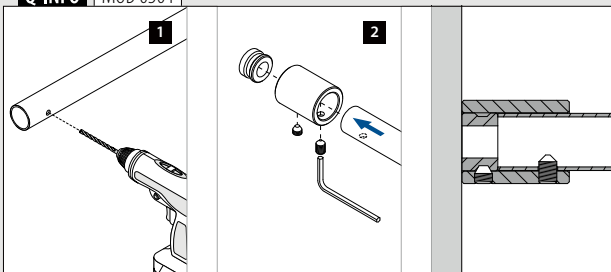

### Q-INFO MOD 1900 / 1910

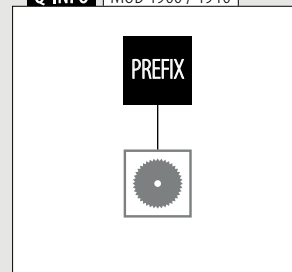

## Absturzstangen Ø16 - MOD 0504

### Montage in der Fensterlaibung

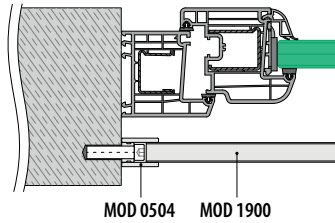

Bitte beachten Sie die Spezifikationen wie zum Beispiel Befestigungsmaße der jeweiligen Zertifikate und statischen Berechnungen.

MOD 0504 MOD 1900

### Handläufe

## Wandflansche

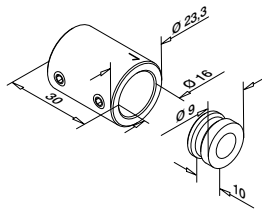

### MOD 0504

V4A	316	Gebürstet		
<b>OUTDOOR</b>				
140504-016-12	QS-27	474		2

NEW

### Füllungen

## Rohre

Q-TUBE

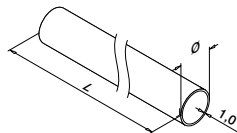

### MOD 1900

V4A	316	Gebürstet	Ø	
<b>OUTDOOR</b>				
141900-016-50-12			16	L = 5 m



### Q-INFO

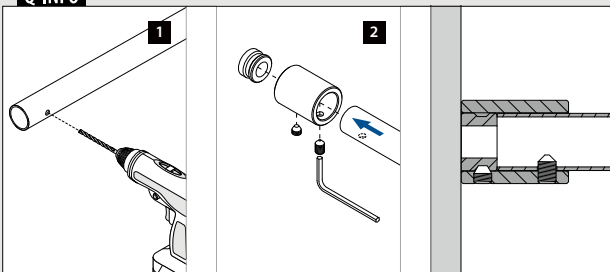

### Q-INFO MOD 1900

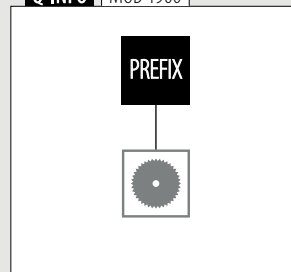

Absturzsangen Ø16 - MOD 0842 / 0843

Fassadenmontage

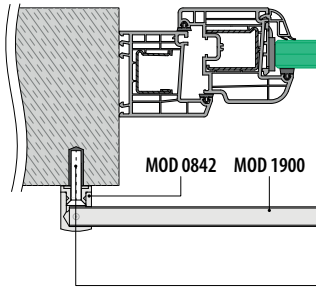

Rahmenmontage

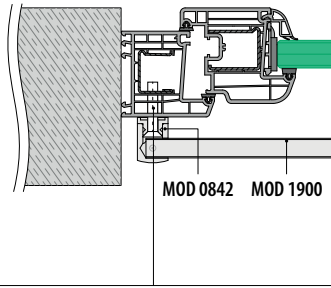

Bitte beachten Sie die Spezifikationen wie zum Beispiel Befestigungsmaße der jeweiligen Zertifikate und statischen Berechnungen.

Anker: ■459 - 465

Handläufe

Wandflansche



Links

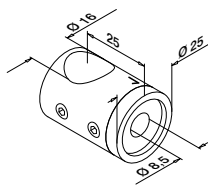

MOD 0842

V4A	316	Gebürstet		
<b>OUTDOOR</b>				
140842-000-12	QS-22	■474	4	

NEW



Rechts

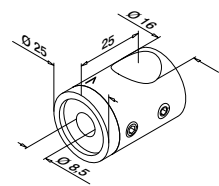

MOD 0843

V4A	316	Gebürstet		
<b>OUTDOOR</b>				
140843-000-12	QS-22	■474	4	

NEW

Füllungen

Rohre

Q-TUBE

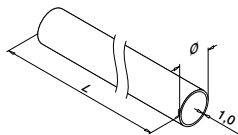

MOD 1900

V4A	316	Gebürstet		
<b>OUTDOOR</b>				
141900-016-50-12	Ø		L = 5 m	

PREFIX



Füllungen

Endkappen

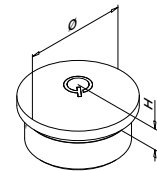

MOD 1729

V4A	316	Gebürstet		
<b>OUTDOOR</b>				
141729-016-12	Für Rohr Ø	H		
	16,0 x 1,0	4	2	



Q-INFO | MOD 0842 / 0843

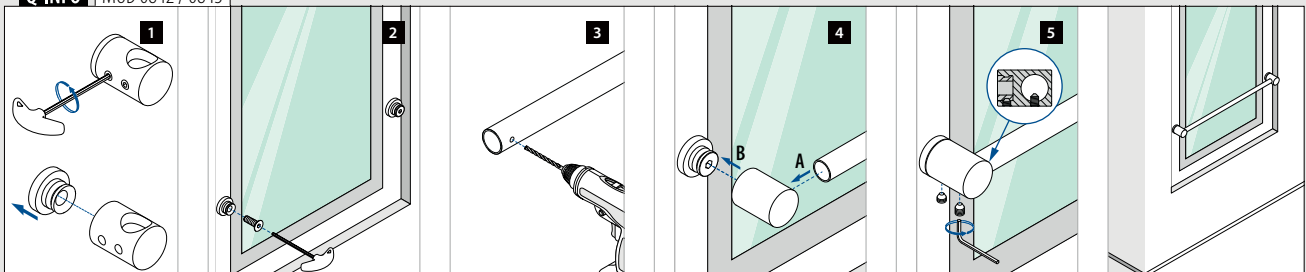



Glasleistenrohre

**Absturzstangen Ø33,7 - MOD 0504**

Montage in der Fensterlaibung

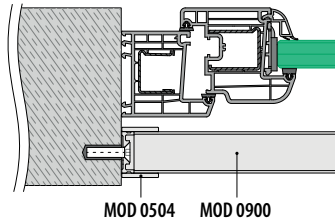

Bitte beachten Sie die Spezifikationen wie zum Beispiel Befestigungsmaße der jeweiligen Zertifikate und statischen Berechnungen.

Glasleistenrohre

**Absturzstangen Ø33,7 - MOD 0505 / 0506**

Montage in der Fensterlaibung

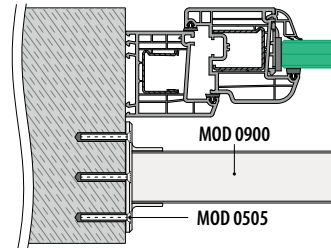

Bitte beachten Sie die Spezifikationen wie zum Beispiel Befestigungsmaße der jeweiligen Zertifikate und statischen Berechnungen.

Handläufe

**Wandflansche**

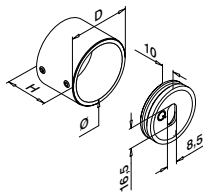

**MOD 0504**

V4A	316	Gebürstet						
	<b>OUTDOOR</b>	Ø	D	H				
140504-033-12		33,7	41	30	QS-55	472 / QS-22	474	2

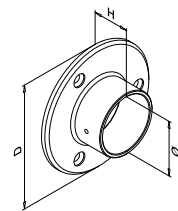

**MOD 0505**

V4A	316	Gebürstet						
	<b>OUTDOOR</b>	Für Rohr Ø	D	H				
140505-033-12		33,7	85	30	QS-50	473		2



Handläufe

**Wandflansche**

**Justierbar**



0 - 50°

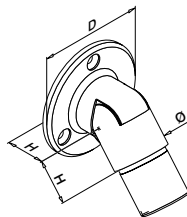

**MOD 0506**

V4A	316	Gebürstet						
	<b>OUTDOOR</b>	Für Rohr Ø	D	H				
140506-033-12		33,7 x 2,0	70	26	QS-50	473		2



Internationaler Geschmacksmusterschutz

Handläufe

**Rohre**

**Q-TUBE**

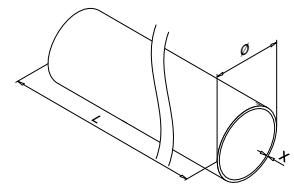

**MOD 0900**

V4A	316	Gebürstet						
	<b>OUTDOOR</b>	Ø	X					
140900-233-50-12		33,7	2,0				L = 5 m	



**Q-INFO** | MOD 0504

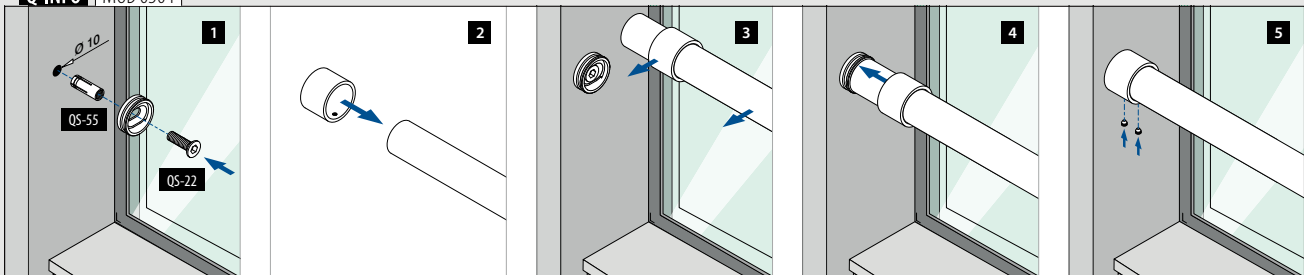

## Absturzstangen Ø33,7 - MOD 6517

Fassadenmontage

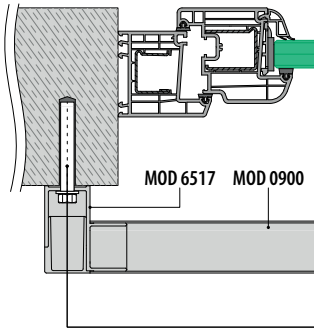

Rahmenmontage

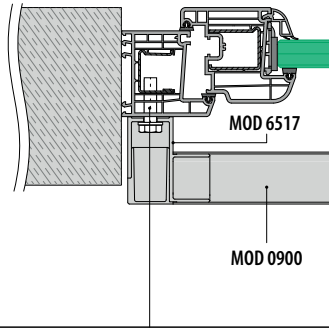

Bitte beachten Sie die Spezifikationen wie zum Beispiel Befestigungsmaße der jeweiligen Zertifikate und statischen Berechnungen.

Anker: ■459 - 465

## Wandflansche

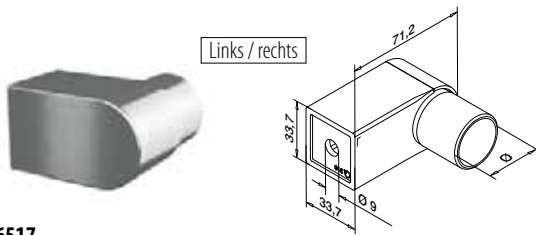

### MOD 6517

V4A	316	Gebürstet		
	<b>OUTDOOR</b>	<b>Für Rohr Ø</b>		
146517-233-12		33,7 x 2,0	QS-27 ■474	2

NEW

## Rohre

Q-TUBE

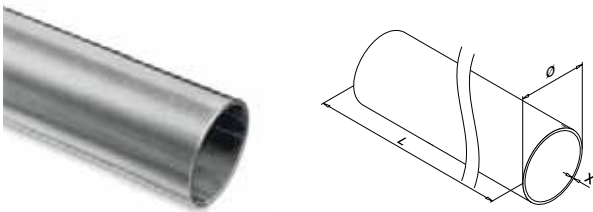

### MOD 0900

V4A	316	Gebürstet		
	<b>OUTDOOR</b>	<b>Ø</b>	<b>X</b>	
140900-233-50-12		33,7	2,0	L = 5 m

PREFIX



### Q-INFO

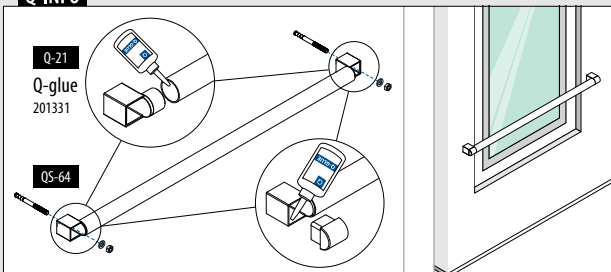

### Q-INFO MOD 0900

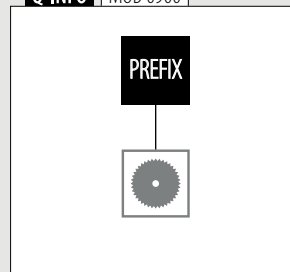

Absturzstangen Ø33,7 - MOD 0523

Fassadenmontage

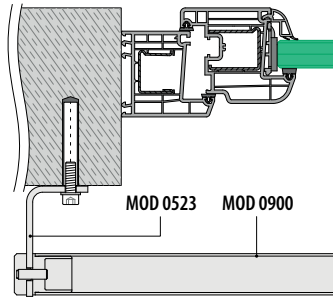

Bitte beachten Sie die Spezifikationen wie zum Beispiel Befestigungsmaße der jeweiligen Zertifikate und statischen Berechnungen.

Handläufe

Wandflansche

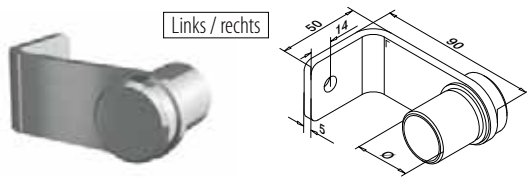

Links / rechts

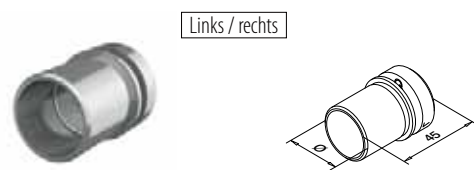

Links / rechts

MOD 0523

V4A	316	Gebürstet		
	<b>OUTDOOR</b>	<b>Für Rohr Ø</b>		
140523-033-12		33,7 x 2,0	QS-30 474	2

NEW

MOD 3523

V4A	316	Gebürstet		
	<b>OUTDOOR</b>	<b>Für Rohr Ø</b>		
143523-033-12		33,7 x 2,0		2

NEW

Handläufe

Rohre

Q-TUBE

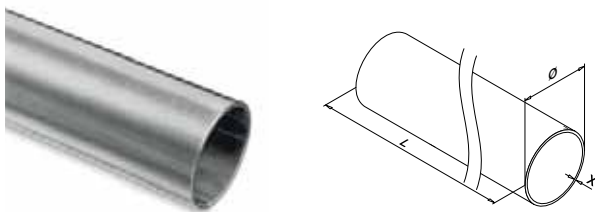

MOD 0900

V4A	316	Gebürstet		
	<b>OUTDOOR</b>	<b>Ø</b>	<b>X</b>	
140900-233-50-12		33,7	2,0	L = 5 m



Q-INFO MOD 0523

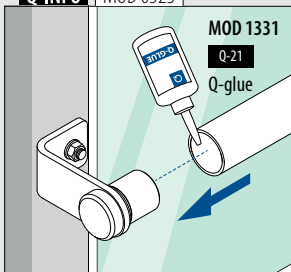

Q-INFO MOD 0900

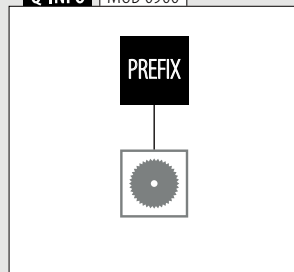

Absturztangen Ø42,4 - MOD 0504

Montage in der Fensterlaibung

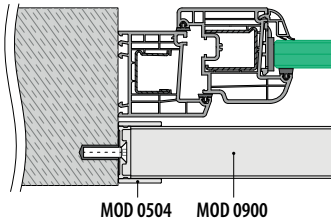

Bitte beachten Sie die Spezifikationen wie zum Beispiel Befestigungsmaße der jeweiligen Zertifikate und statischen Berechnungen.

Absturztangen Ø42,4 - MOD 0505

Montage in der Fensterlaibung

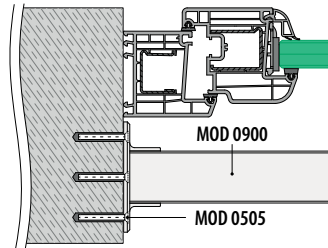

Bitte beachten Sie die Spezifikationen wie zum Beispiel Befestigungsmaße der jeweiligen Zertifikate und statischen Berechnungen.

Handläufe

Wandflansche

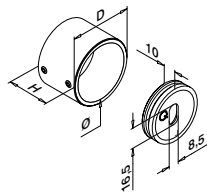

MOD 0504

V4A	316	Gebürstet					
	OUTDOOR	Ø	D	H			
140504-042-12		42,4	50	35	QS-55	472 / QS-22	474 2

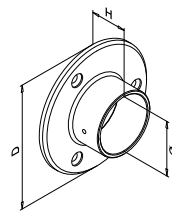

MOD 0505

V4A	316	Gebürstet					
	OUTDOOR	Für Rohr Ø	D	H			
140505-042-12		42,4	95	30	QS-50	473	2



Handläufe

Wandflansche

Justierbar



0 - 50°

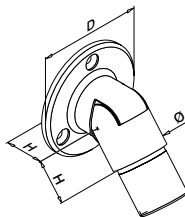

MOD 0506

V4A	316	Gebürstet					
	OUTDOOR	Für Rohr Ø	D	H			
140506-042-12		42,4 x 2,0	75	30	QS-50	473	2

NEW



Internationaler Geschmacksmusterschutz

Handläufe

Rohre

Q-TUBE

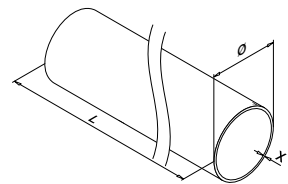

MOD 0900

V4A	316	Gebürstet					
	OUTDOOR	Ø	X				
140900-242-50-12		42,4	2,0			L = 5 m	

PREFIX



Q-INFO MOD 0504

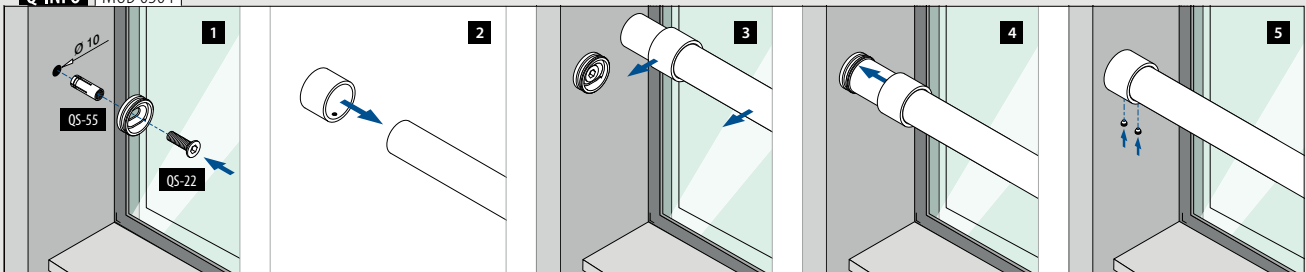

Absturzstangen Ø42,4 - MOD 6517

Fassadenmontage

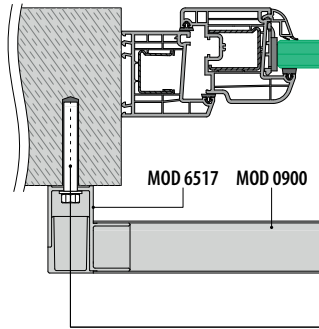

Rahmenmontage

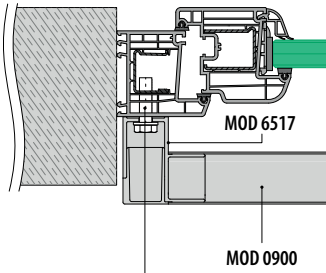

Bitte beachten Sie die Spezifikationen wie zum Beispiel Befestigungsmaße der jeweiligen Zertifikate und statischen Berechnungen.

Anker: ■459 - 465

Handläufe

Wandflansche

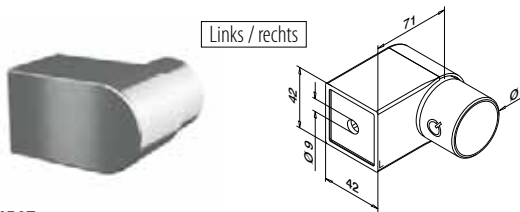

MOD 6517

V4A	316	Gebürstet		
	<b>OUTDOOR</b>	<b>Für Rohr Ø</b>		
146517-242-12		42,4 x 2,0	QS-27 ■474	2

NEW

Handläufe

Rohre

Q-TUBE

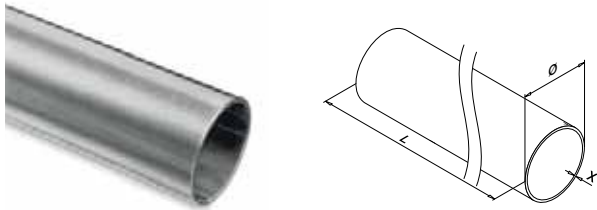

MOD 0900

V4A	316	Gebürstet		
	<b>OUTDOOR</b>	<b>Ø</b>	<b>X</b>	
140900-242-50-12		42,4	2,0	L = 5 m



Q-INFO

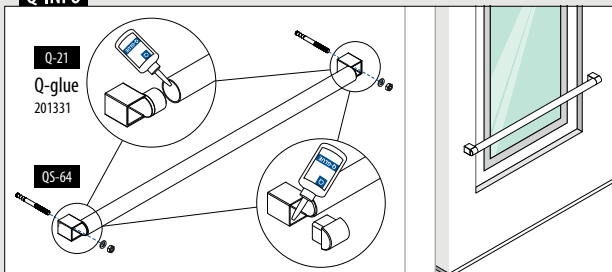

Q-INFO MOD 0900

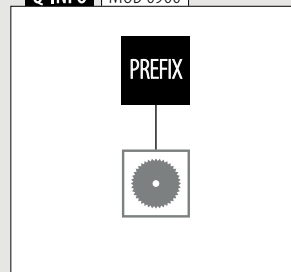





# STAB AUSFACHUNG FÜR EASY ALU

Die Stabausfachung (vertikale Stabfüllung) für Easy Alu ist sowohl für Neubauten als auch Renovierungsobjekte ideal. Die Füllungen können Sie zudem in jeder gewünschten RAL-Farbe pulverbeschichten lassen, damit es zum Farbschema des Gebäudes passt. Diese Option für französische Balkone ist auf Anfrage erhältlich.



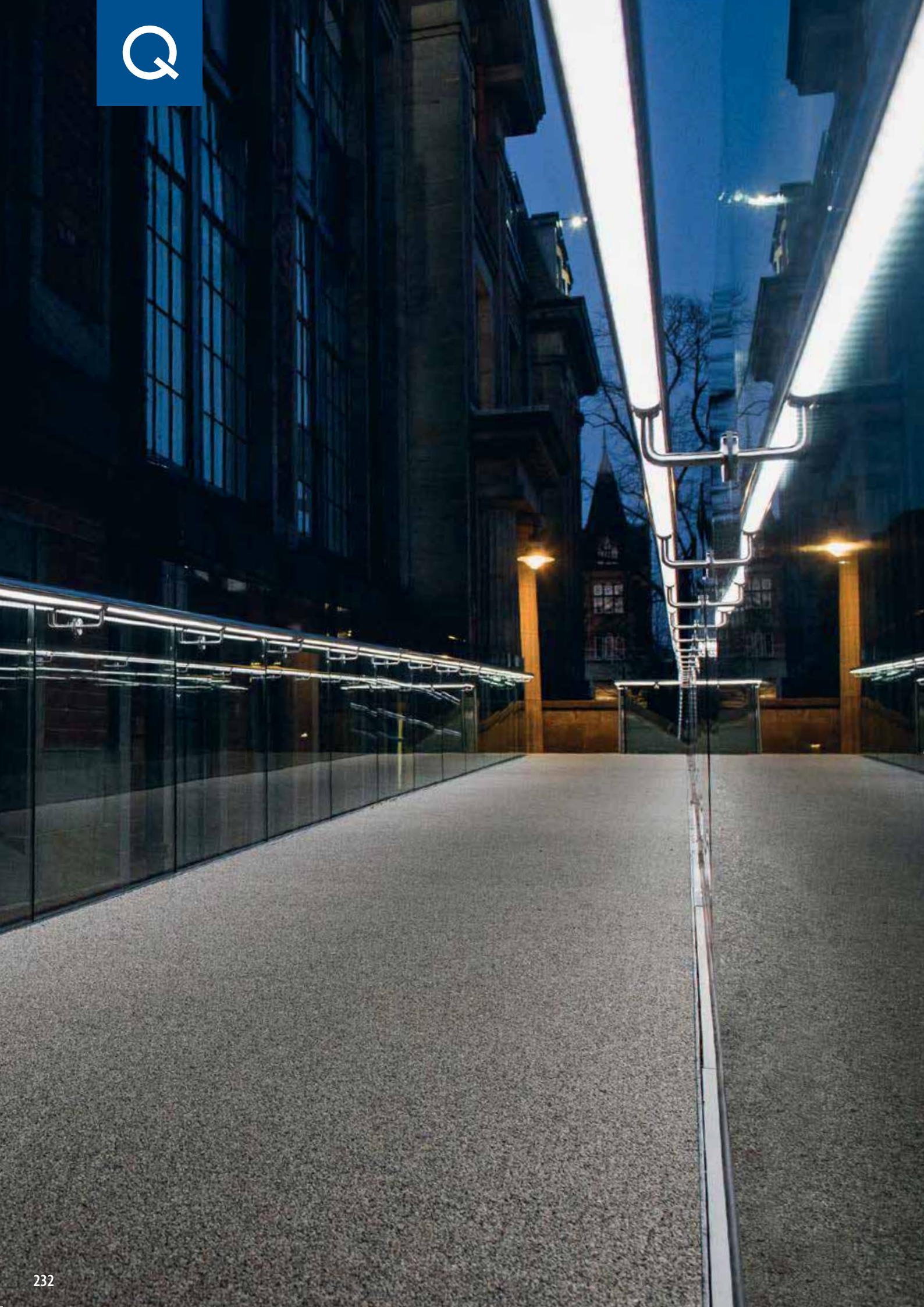

**3**

# Q-LIGHTS SYSTEME

Q-lights Spotlight ————— 236 - 237, 260 - 262, 265  
Q-lights Linear Light ————— 238 - 265





**Beanspruchung:** Leicht bis hoch (IK10 vandalismussicher)

**Verwendung:** Innen- und Außenbereich (IP00 - IP66)

**Varianten:** 24 V und 48 V warm-, neutral- und kaltweißes Licht, RGB-Licht auf Anfrage (Linear Light) und 3000 / 5000K, 12 V (Spotlight)

**Anwendung:** Ganzglasgeländer, Pfostengeländer, wandmontierte Handläufe

**Material:** Aluminium, Edelstahl V2A oder V4A

Finden Sie alle Informationen zu Spotlight online:



<https://q-ne.ws/Spotlight23>

Finden Sie alle Informationen zu Linear Light online:



<https://q-ne.ws/LinearLight23>

# Q-LIGHTS SYSTEME



Q-lights Spotlight



Q-lights Linear Light

## Ambiente und Sicherheit steigern

Wenn Sie ein Geländer mit einer gut designten Beleuchtung versehen, verändern Sie nicht nur das Ambiente, sondern machen es auch sicherer für die Benutzer. Q-lights Spotlight und Q-lights Linear Light stellen Ihnen eine beeindruckende Auswahl von Lichteffekten zur Verfügung. Beide LED-Systeme lassen sich ganz einfach in das von Ihnen gewählte Q-railing Geländer integrieren.

International getestet/berechnet/zertifiziert:

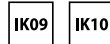

- 1 LED-Bänder: für extrem klare, kraftvolle Lichteffekte.
- 2 LED-Bänder mit bis zu 30 Metern Länge.
- 3 Steigern Sie die Sicherheit, indem Sie Licht zu Ihren Geländern hinzufügen. Mit Q-lights stehen Geländer und Gehwege sowohl im Innen- als auch im Außenbereich im Fokus.



## Q-LIGHTS VARIANTEN

### Spotlight für Handläufe

- Für runde Edelstahlrohre (Ø 42,4 oder 48,3 mm)
- Handlaufstützen, Handlaufadapter und Wandflansche mit Kabelkanal
- Kaltweißes Licht (5000K, 12V), warmweißes Licht (3000K, 12V)

☎ 236 - 237, 260 - 262, 265

### Linear Light für Glasleistenrohre

- LED-Bänder in 5 und 30 Metern Länge
- Bringen Sie die LED-Bänder vor oder hinter dem Glas an
- Transparente oder matte Kunststoffabdeckungen erhältlich
- Warmweißes oder kaltweißes Licht (24V und 48V), RGB-Licht auf Anfrage

☎ 238 - 255

### Linear Light für Handläufe

- LED-Bänder in 5 und 30 Metern Länge
- Handlaufstützen mit Kabelkanal
- Spezielle Adapter für die Montage auf Handlaufstützen
- Transparente oder matte Kunststoffabdeckungen erhältlich
- Warmweißes oder kaltweißes Licht (24V und 48V), RGB-Licht auf Anfrage

☎ 238 - 253, 256 - 265



Für Rohr Ø 42,4 x 2,0 mm

Asymmetrischer Lichtstrahl  
Farbtemperatur 3000K + 5000K  
50.000 Stunden Licht

## MOD 0051

INDOOR	Farbe (K)	Elektr. Spezifikationen	
190051-242-20-30	Warmweiß	0,5W, 12V, 40mA, 22lm	1
190051-242-20-50	Kaltweiß	0,5W, 12V, 40mA, 22lm	1



Für Rohr Ø 48,3 x 2,0 mm

Asymmetrischer Lichtstrahl  
Farbtemperatur 3000K + 5000K  
50.000 Stunden Licht

## MOD 0051

INDOOR	Farbe (K)	Elektr. Spezifikationen	
190051-248-20-30	Warmweiß	0,5W, 12V, 40mA, 22lm	1
190051-248-20-50	Kaltweiß	0,5W, 12V, 40mA, 22lm	1



Für Rohr Ø 42,4 x 2,0 mm

Asymmetrischer Lichtstrahl  
Farbtemperatur 3000K + 5000K  
50.000 Stunden Licht

## MOD 0051

OUTDOOR	Farbe (K)	Elektr. Spezifikationen	
190051-242-66-30	Warmweiß	0,55W, 12V, 45mA, 25lm	1
190051-242-66-50	Kaltweiß	0,55W, 12V, 45mA, 25lm	1

Internationaler  
Geschmacksmusterschutz

Für Rohr Ø 48,3 x 2,0 mm

Asymmetrischer Lichtstrahl  
Farbtemperatur 3000K + 5000K  
50.000 Stunden Licht

## MOD 0051

OUTDOOR	Farbe (K)	Elektr. Spezifikationen	
190051-248-66-30	Warmweiß	0,55W, 12V, 45mA, 25lm	1
190051-248-66-50	Kaltweiß	0,55W, 12V, 45mA, 25lm	1

Internationaler  
Geschmacksmusterschutz

## Q-INFO

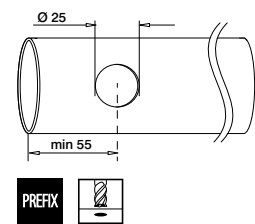

Wir empfehlen, das Loch zu fräsen. Wenn dies nicht möglich ist, sollte ein Stufenbohrer benutzt werden. Entgraten Sie jede Bohrung und entfernen Sie alle Rückstände (Innen- und Außenseite), um eine Beschädigung der Kabel zu verhindern. Erst danach mit der Installation des LED-Systems beginnen.

MOD 0900  
351MOD 0900  
367

## Q-INFO

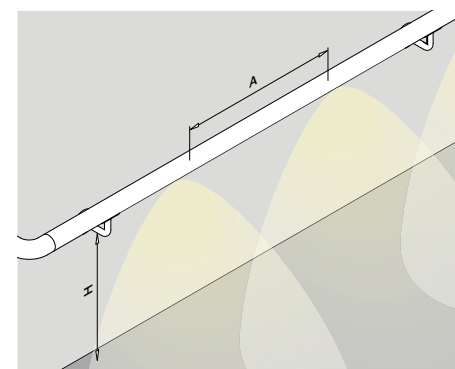

## Lichtausbeute am Boden/auf den Treppenstufen bei einem 900 mm hohen Geländer

Höhe (mm) des Fertigfußboden: 900mm

Distanz von der Wand (mm)	0	Abstand (A) zwischen den einzelnen LED-Spotlights (mm)					
		400		600		1000	
		IP20	IP66	IP20	IP66	IP20	IP66
0	52 lx	56 lx	35 lx	37 lx	20 lx	22 lx	
600	32 lx	35 lx	22 lx	24 lx	13 lx	14 lx	

Für die bestmögliche Lichtausbeute empfehlen wir 600 mm Abstand zwischen den einzelnen LED Spotlights.

Alle Angaben zur Lichtkalkulation sind ein Richtwert, da stets die vor Ort gegebenen räumlichen Anforderungen und gesetzlichen Rahmenbedingungen berücksichtigt werden müssen. Wir empfehlen, dass Sie einen Lichtarchitekten oder Elektroingenieur konsultieren, um die genauen Anforderungen für Ihr Projekt zu bestimmen.

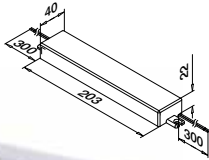

**Transformator 12V**  
220...240V~, CE, ohne Stecker

**MOD 0013**

IN/OUTDOOR	P	
200013-030-66	30W	1

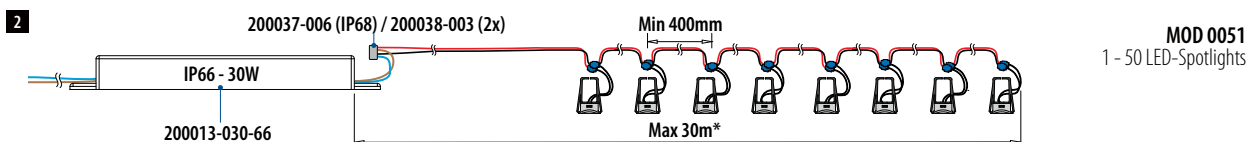
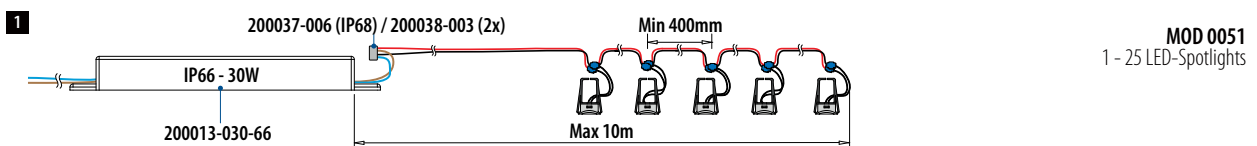
**Q-INFO****Indoor / outdoor**

\* EMI/EMC-Konformität beachten

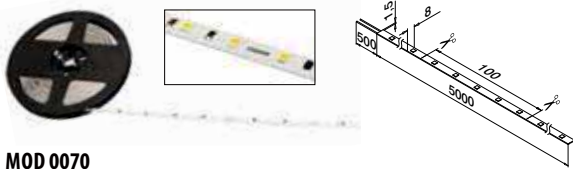
**MOD 0070**

INDOOR	Farbe (K)	LED/m	W	Φ (lm/m)	☐
190070-050-27	Warmweiß	70	14	350	L = 5 m
190070-050-65	Kaltweiß	70	14	370	L = 5 m

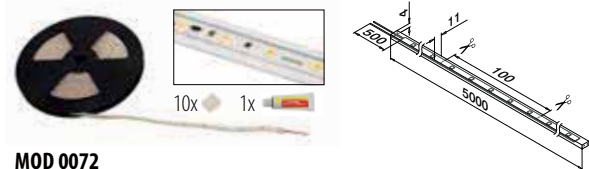
**MOD 0072**

OUTDOOR	Farbe (K)	LED/m	W	Φ (lm/m)	☐
190072-050-30	Warmweiß	70	14	350	L = 5 m
190072-050-65	Kaltweiß	70	14	360	L = 5 m

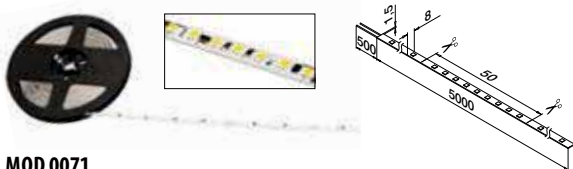
**MOD 0071**

INDOOR	Farbe (K)	LED/m	W	Φ (lm/m)	☐
190071-050-27	Warmweiß	140	27,5	660	L = 5 m
190071-050-65	Kaltweiß	140	27,5	680	L = 5 m

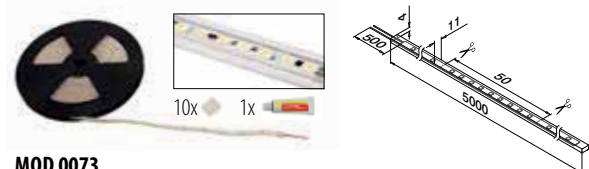
**MOD 0073**

OUTDOOR	Farbe (K)	LED/m	W	Φ (lm/m)	☐
190073-050-30	Warmweiß	140	27,5	640	L = 5 m
190073-050-65	Kaltweiß	140	27,5	650	L = 5 m

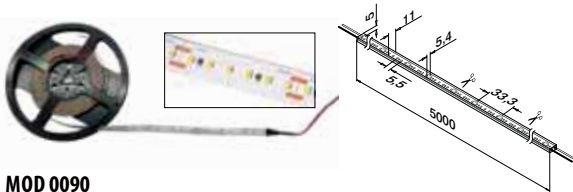
**MOD 0090**

INDOOR	Farbe (K)	LED/m	W	Φ (lm/m)	☐
190090-050-40	Neutralweiß	180	30	650	L = 5 m

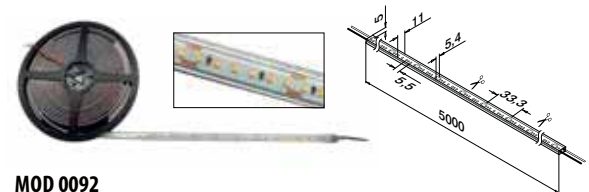
**MOD 0092**

OUTDOOR	Farbe (K)	LED/m	W	Φ (lm/m)	☐
190092-050-40	Neutralweiß	180	30	650	L = 5 m

**Q-INFO**

MOD 0070 / 0072: 70 LED/m
MOD 0071 / 0073: 140 LED/m
MOD 0090 / 0092: 180 LED/m

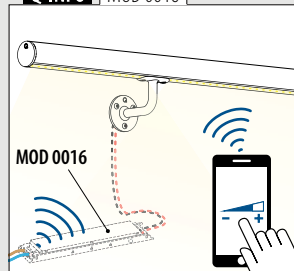
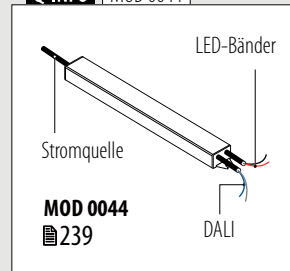
**Q-INFO** MOD 0016**Q-INFO** MOD 0044**Q-INFO**

## INFORMATIONEN ZU DEN LED-BÄNDERN

- Alle LED-Bänder sind vorverkabelt an einem Ende. Für weitere Verbindungen, verwenden Sie ein Anschlusskabel (■ 240-242).
- Alle LED-Bänder können mit einer Schere (zwischen den Kupferpunkten) auf die gewünschte Länge zugeschnitten werden
- LED-Bänder können zugeschnitten und mittels Steckern verbunden werden (■ 240-242).
- Alle Modelle sind für Verbinder bei Linear Light Glasleistenrohre (■ 254-255) und Linear Light Handläufen geeignet (■ 256-265).

Transformatoren

**Transformator 24V**  
für Q-lights Linear Light IP20  
220...240V~



**MOD 0015**

<b>INDOOR</b>	<b>P</b>	
200015-100-20	100W	1



**Transformator 24V**  
für Q-lights Linear Light IP67  
220...240V~

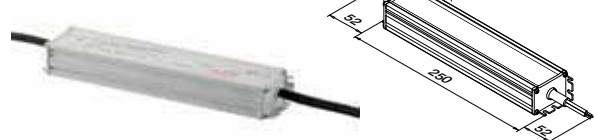

**MOD 0015**

<b>OUTDOOR</b>	<b>P</b>	
200015-100-67	100W	1



**Transformator mit Bluetooth-Steuerung 24V**  
für Q-lights Linear Light IP20  
220...240V~



**MOD 0016**

<b>INDOOR</b>	<b>P</b>	
200016-080	80W	1



**Transformator 24V mit DALI**  
für Q-lights Linear Light IP67  
220...240V~ CE

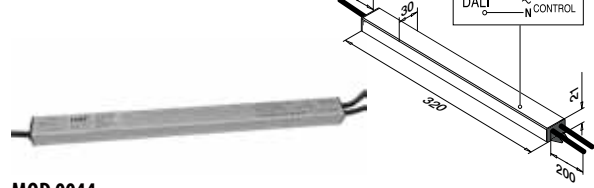

**MOD 0044**

<b>OUTDOOR</b>	<b>P</b>	
200044-100-67	100W	1



**Q-INFO** | MOD 007x / 009x

Übersicht Q-lights Linear Light LED-Bänder

LED-Bänder	IP	V	W	W/m	K	Colour	lm	lm/m		LED/m	L (mm)	L <sub>mm</sub> (mm)			CRI	
190070-050-27	00	24	14	2,8	2700	warmweiß	1750	350	120	70	5000	100	✓	50.000 h	>80	20
190070-050-65	00	24	14	2,8	6500	kaltweiß	1850	370	120	70	5000	100	✓	50.000 h	>80	20
190072-050-30	66	24	14	2,8	3000	warmweiß	1750	350	120	70	5000	100	✓	50.000 h	>80	20
190072-050-65	66	24	14	2,8	6500	kaltweiß	1800	360	120	70	5000	100	✓	50.000 h	>80	20
190071-050-27	00	24	27,5	5,5	2700	warmweiß	3100	620	120	140	5000	50	✓	50.000 h	>80	50
190071-050-65	00	24	27,5	5,5	6500	kaltweiß	3400	680	120	140	5000	50	✓	50.000 h	>80	50
190073-050-30	66	24	27,5	5,5	3000	warmweiß	3200	640	120	140	5000	50	✓	50.000 h	>80	50
190073-050-65	66	24	27,5	5,5	6500	kaltweiß	3250	650	120	140	5000	50	✓	50.000 h	>80	50
190090-050-40	20	24	30	6	4000	neutralweiß	3250	650	120	180	5000	33,33	✓	50.000 h	94	50
190092-050-40	54	24	30	6	4000	neutralweiß	3250	650	120	180	5000	33,33	✓	50.000 h	94	50

<b>IP...</b>	IP Schutzart	<b>W/m</b>	Nennleistung pro Meter	<b>lm</b>	Lichtstrom	<b>LED/m</b>	Anzahl LEDs pro Meter
<b>V</b>	Nennspannung	<b>K</b>	Farbtemperatur	<b>lm/m</b>	Lichtstrom pro Meter		Dimmbar
<b>W</b>	Nennleistung	<b>Colour</b>	Lichtfarbe		Ausstrahlungswinkel		Lebensdauer

**Q-INFO** | MOD 007x

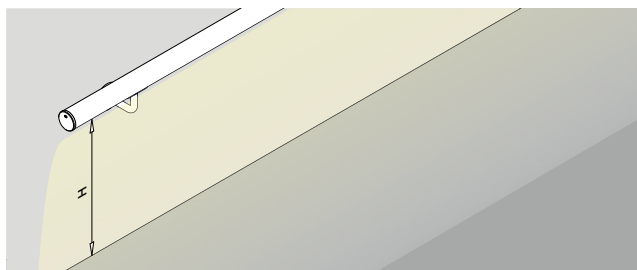

**Lux (lx) Erläuterung**

Direktes Sonnenlicht	= 100.000 lx	Flurbeleuchtung	= 100 lx
Tageslicht bei Bewölkung	= 1.000 lx	Straßenbeleuchtung	= 10 lx
typisches Studiolicht		Kerzenlicht aus 1 m Entfernung	= 1 lx

Lichtausbeute am Boden/auf den Treppenstufen

	Höhe (mm) des Fertigfußbodens			
	900	1000	1100	1200
190070-050-27	125 lx	106 lx	90 lx	78 lx
190070-050-65	144 lx	113 lx	94 lx	82 lx
190072-050-30	106 lx	90 lx	75 lx	66 lx
190072-050-65	111 lx	94 lx	78 lx	69 lx
190071-050-27	203 lx	172 lx	144 lx	121 lx
190071-050-65	223 lx	198 lx	151 lx	131 lx
190073-050-30	203 lx	172 lx	120 lx	92 lx
190073-050-65	217 lx	184 lx	130 lx	100 lx
190090-050-40	163 lx	139 lx	120 lx	104 lx
190092-050-40	163 lx	139 lx	120 lx	104 lx

Alle Angaben zur Lichtkalkulation sind ein Richtwert, da stets die vor Ort gegebenen räumlichen Anforderungen und gesetzlichen Rahmenbedingungen berücksichtigt werden müssen. Wir empfehlen, dass Sie einen Lichtarchitekten oder Elektroingenieur konsultieren, um die genauen Anforderungen für Ihr Projekt zu bestimmen.



Universalverbinder, Streifen zu Streifen



MOD 0046

INDOOR	Für MOD	V	
200046-008	0070, 0071	24 / 48	1
200046-010	0080, 0090	24 / 48	1

NEW IP20

Universal-Eckverbinder

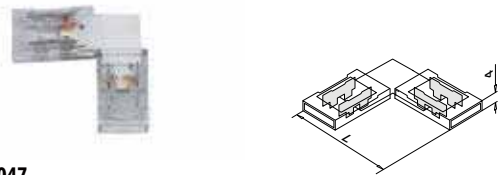

MOD 0047

INDOOR	Für MOD	V	L	
200047-008	0070, 0071	24 / 48	25	1
200047-010	0080, 0090	24 / 48	30	1

NEW IP20

Universal-Flex-Verbinder

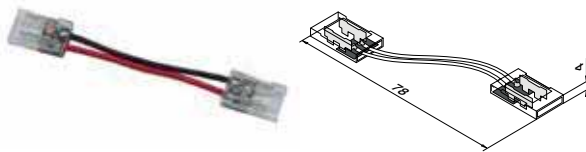

MOD 0048

INDOOR	Für MOD	V	
200048-008	0070, 0071	24 / 48	1
200048-010	0080, 0090	24 / 48	1

NEW IP20

Universal-Anschlusskabel

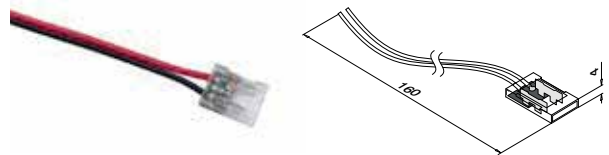

MOD 0049

INDOOR	Für MOD	V	
200049-008	0070, 0071	24 / 48	1
200049-010	0080, 0090	24 / 48	1

NEW IP20

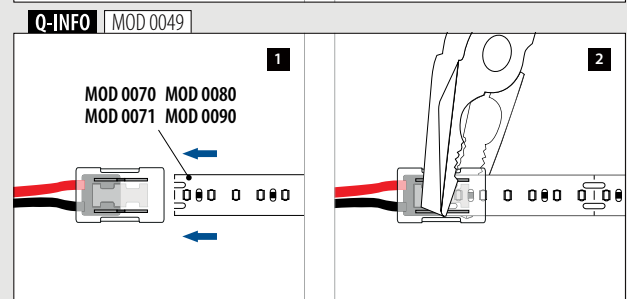
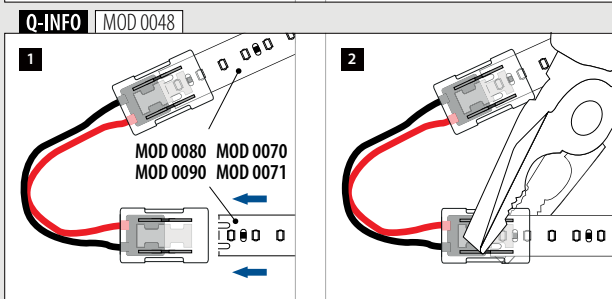
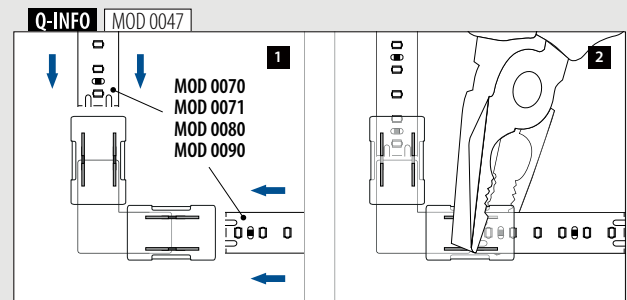
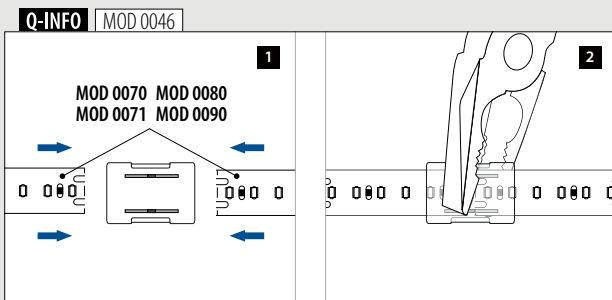

Universalverbinder, Streifen zu Streifen

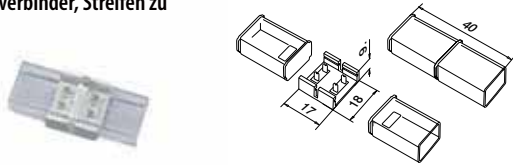

MOD 0053

OUTDOOR	Für MOD	V	
200053	0072, 0073, 0082, 0092	24 / 48	1



Universal-Flex-Verbinder

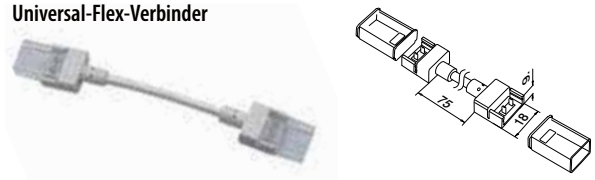

MOD 0054

OUTDOOR	Für MOD	V	
200054	0072, 0073, 0082, 0092	24 / 48	1



Universal-Anschlusskabel

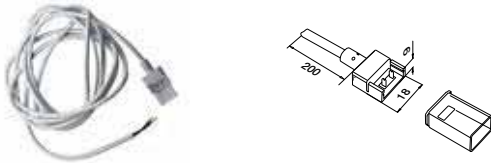

MOD 0055

OUTDOOR	Für MOD	V	
200055	0072, 0073, 0082, 0092	24 / 48	1



Silikon + Endkappen

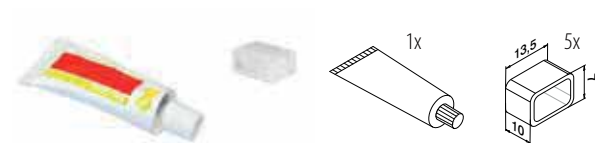

MOD 0039

OUTDOOR		
200039	1	

Q-INFO | MOD 0053 / 0054 / 0055

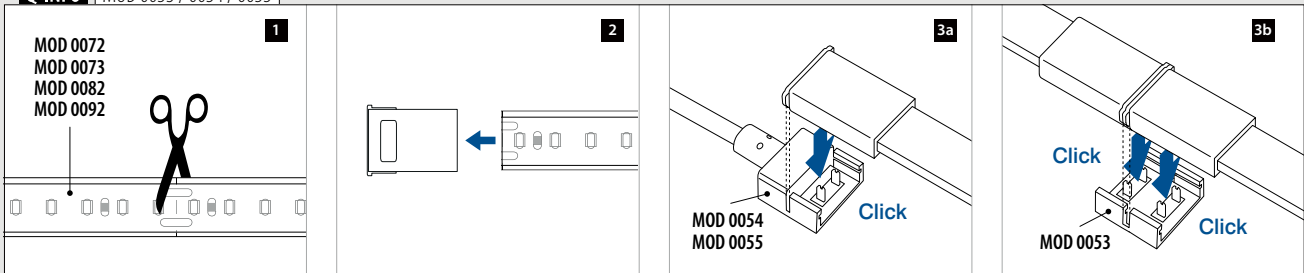

Q-INFO | MOD 0039

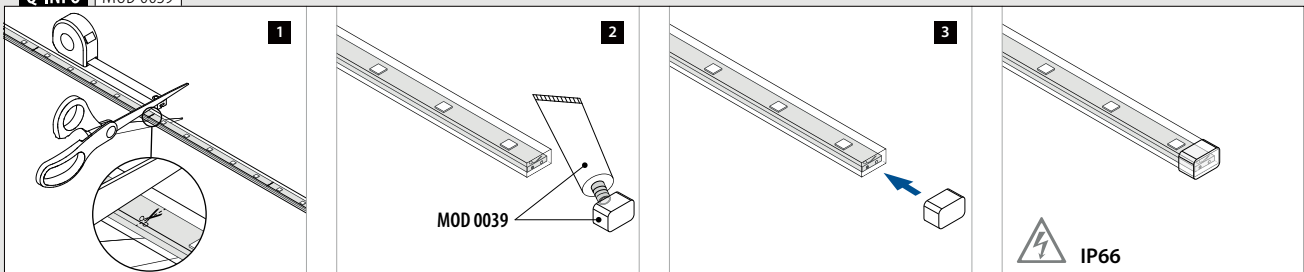

**Anschlusskabel für LED-Bänder**  
für MOD 0070 / 0071

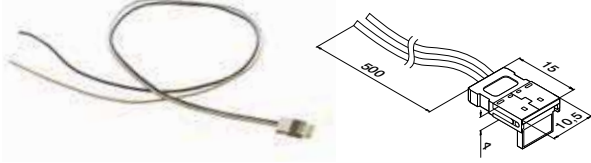

MOD 0020	INDOOR	V	L	
200020-20		24	500	1
IP20				

**Anschlusskabel für LED-Bänder**  
für MOD 0072 / 0073

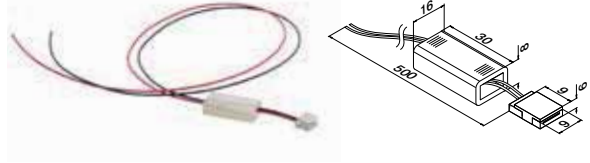

MOD 0020	OUTDOOR	V	L	
200020-54		24V	500	1
IP54				

**Verbinder für LED-Bänder**



MOD 0018	INDOOR		
200018			1
IP20			

**Verbindungskabel für LED-Bänder**



MOD 0019	INDOOR		
200019			1
IP20			

**Hülse für LED-Band Verbinder**  
für LED-Bänder MOD 0072 / 0073



MOD 0023	OUTDOOR		
200023			1
IP54			

**SELL OUT** Nur solange der Vorrat reicht.

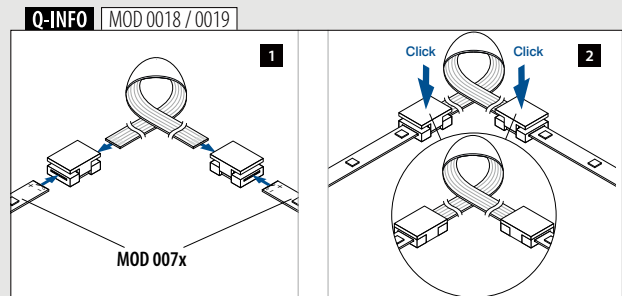
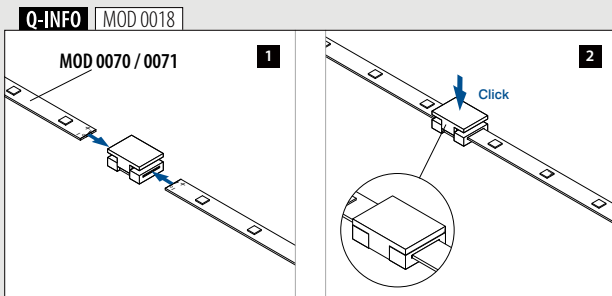
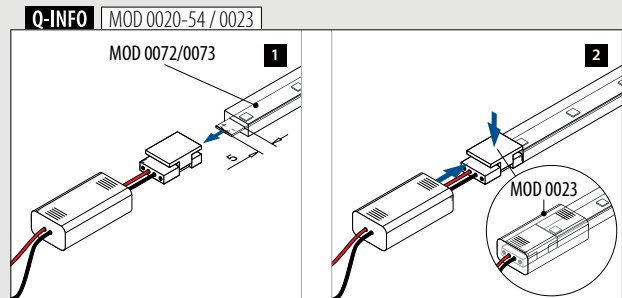
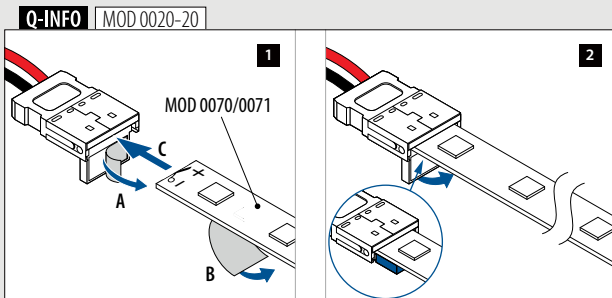

Q-INFO | MOD 0070/0071

Indoor

1

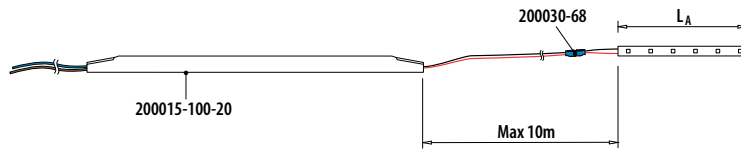

MOD 0070/0071  
 $L_A \leq 5,00 \text{ m}$

2

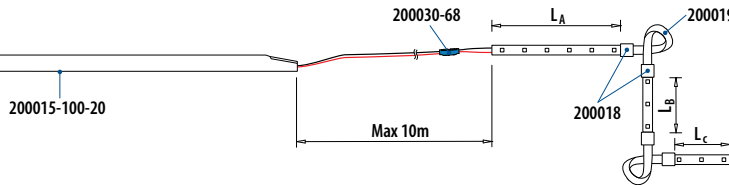

MOD 0070/0071  
 $L_A + L_B + L_C \leq 5,00 \text{ m}$

3A

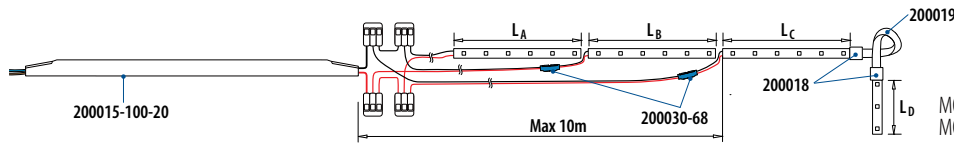

MOD 0070/0071  
 $L_A \leq 5,00 \text{ m}$   
 $L_B \leq 5,00 \text{ m}$   
 $L_C + L_D \leq 5,00 \text{ m}$   
 MOD 0070:  $L_A + L_B + L_C + L_D \leq 20,00 \text{ m}$   
 MOD 0071:  $L_A + L_B + L_C + L_D \leq 15,00 \text{ m}$

3B

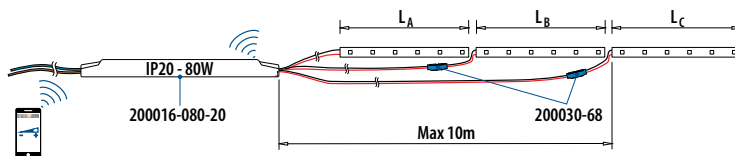

MOD 0070/0071  
 $L_A + L_B \leq 5,00 \text{ m}$   
 $L_C \leq 5,00 \text{ m}$   
 $L_D \leq 5,00 \text{ m}$   
 MOD 0070:  $L_A + L_B + L_C + L_D \leq 15,00 \text{ m}$   
 MOD 0071:  $L_A + L_B + L_C + L_D \leq 13,50 \text{ m}$

Q-INFO | MOD 0072/0073

Outdoor

4

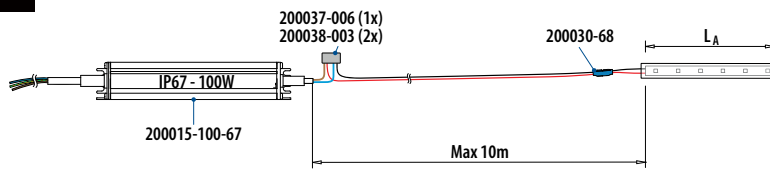

MOD 0072/0073  
 $L_A + L_B + L_C \leq 5,00 \text{ m}$

5

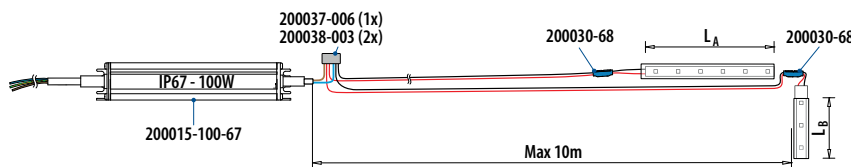

MOD 0072/0073  
 $L_A \leq 5,00 \text{ m}$   
 $L_B \leq 5,00 \text{ m}$   
 $L_C + L_D \leq 5,00 \text{ m}$   
 $L_A + L_B + L_C + L_D \leq 15,00 \text{ m}$

6

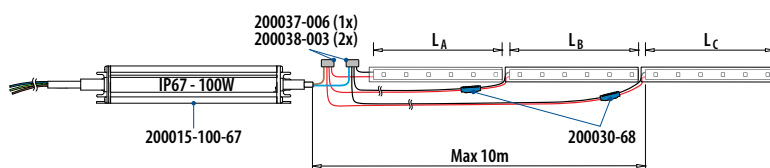

MOD 0072/0073  
 $L_A \leq 5,00 \text{ m}$   
 $L_B \leq 5,00 \text{ m}$   
 $L_C + L_D \leq 5,00 \text{ m}$   
 $L_A + L_B + L_C + L_D \leq 15,00 \text{ m}$

Q-INFO | MOD 0090

Indoor

1

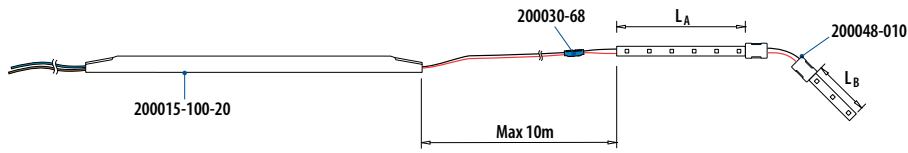

**MOD 0090**  
 $L_A \leq 5,00 \text{ m}$   
 $L_B \leq 5,00 \text{ m}$   
 $L_A + L_B \leq 10,00 \text{ m}$

2

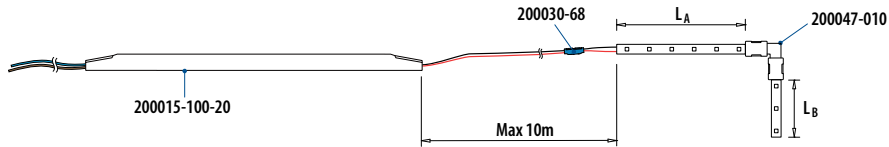

**MOD 0090**  
 $L_A \leq 5,00 \text{ m}$   
 $L_B \leq 5,00 \text{ m}$   
 $L_A + L_B \leq 10,00 \text{ m}$

3

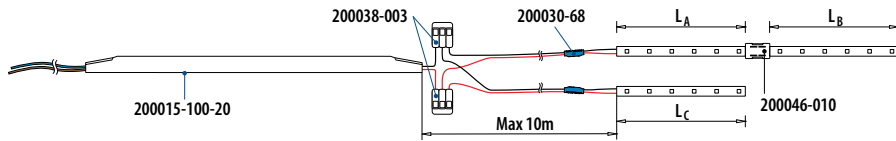

**MOD 0090**  
 $L_A \leq 5,00 \text{ m}$   
 $L_B \leq 5,00 \text{ m}$   
 $L_A + L_B \leq 10,00 \text{ m}$   
 $L_A + L_B + L_C \leq 15,00 \text{ m}$

Q-INFO | MOD 0092

Outdoor

4

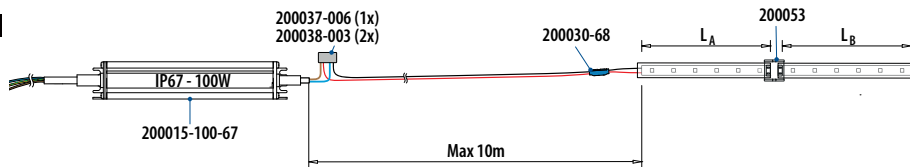

**MOD 0092**  
 $L_A + L_B \leq 10,00 \text{ m}$

5

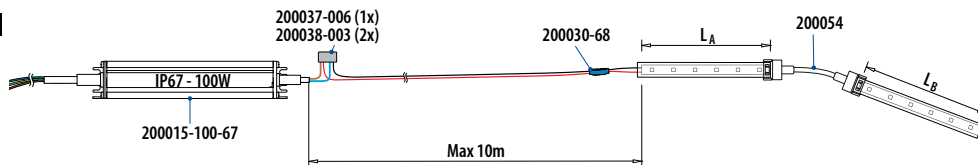

**MOD 0092**  
 $L_A + L_B \leq 10,00 \text{ m}$

6

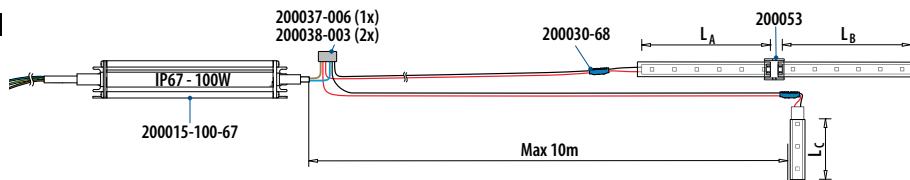

**MOD 0092**  
 $L_A \leq 5,00 \text{ m}$   
 $L_B \leq 5,00 \text{ m}$   
 $L_A + L_B \leq 10,00 \text{ m}$   
 $L_A + L_B + L_C \leq 15,00 \text{ m}$

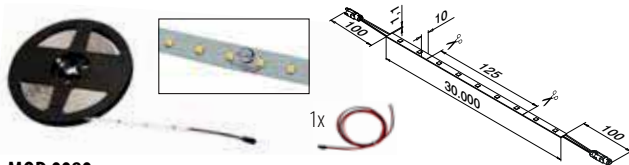

**MOD 0080**

INDOOR	Farbe (K)	LED/m	W	Φ (lm/m)	☐
190080-300-30	Warmweiß	84	117	424	<b>L = 30 m</b>
190080-300-65	Kaltweiß	84	117	437	<b>L = 30 m</b>

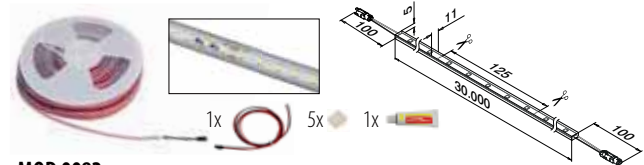
**MOD 0082**

OUTDOOR	Farbe (K)	LED/m	W	Φ (lm/m)	☐
190082-300-30	Warmweiß	84	117	390	<b>L = 30 m</b>
190082-300-65	Kaltweiß	84	117	402	<b>L = 30 m</b>

**Q-INFO**

## INFORMATIONEN ZU DEN LED-BÄNDERN

- Alle LED-Bänder sind vorverkabelt an einem Ende. Für weitere Verbindungen, verwenden Sie ein Anschlusskabel (■ 247-250).
- Alle LED-Bänder können mit einer Schere (zwischen den Kupferpunkten) auf die gewünschte Länge zugeschnitten werden.
- LED-Bänder können zugeschnitten und mittels Steckern verbunden werden (■ 247-250).
- Alle Modelle sind für Verbinder bei Linear Light Glasleistenrohre (■ 254-255) und Linear Light Handläufen geeignet (■ 256-265).

**Transformator 48V**  
für Q-lights Linear Light IP67  
220...240V~, CE

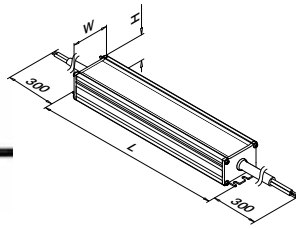

**MOD 0017**

OUTDOOR	P	L	W	H	
200017-060-67	60 W	116	67,5	36,5	1
200017-150-67	150 W	166	67,5	40	1
200017-350-67	350 W	227	80	42	1



**Transformator 48V**  
für Q-lights Linear Light IP67  
220...240V~, CE

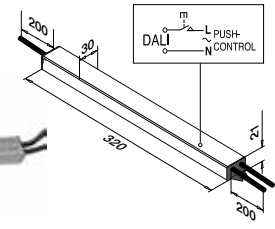

**MOD 0045**

OUTDOOR	W	
200045-240-67	240	1



**Transformator 48V**  
für Q-lights Linear Light IP67  
220...240V~, CE

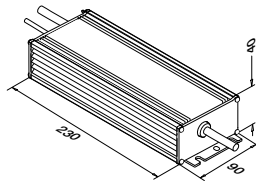

**MOD 0045**

OUTDOOR	W	
200045-400-67	400	1



**Q-INFO** | MOD 0045

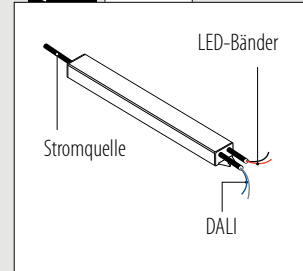

**Q-INFO** | MOD 008x

Übersicht Q-lights Linear Light LED-Bänder

LED-Bänder	IP	V	W	W/m	K	Colour	lm	lm/m		LED/m	L (mm)	L <sub>min</sub> (mm)			CRI	
190080-300-30	20	48	117	3,9	3000	warmweiß	12.720	424	120	84	30.000	125	✓	50.000 h	>80	30
190080-300-65	20	48	117	3,9	6500	kaltweiß	13.110	437	120	84	30.000	125	✓	50.000 h	>80	30
190082-300-30	66	48	117	3,9	3000	warmweiß	11.700	390	120	84	30.000	125	✓	50.000 h	>80	30
190082-300-65	66	48	117	3,9	6500	kaltweiß	12.060	402	120	84	30.000	125	✓	50.000 h	>80	30

<b>IP...</b> IP Schutzart	<b>W/m</b> Nennleistung pro Meter	<b>lm</b> Lichtstrom	<b>LED/m</b> Anzahl LEDs pro Meter
<b>V</b> Nennspannung	<b>K</b> Farbtemperatur	<b>lm/m</b> Lichtstrom pro Meter	Dimmbar
<b>W</b> Nennleistung	<b>Colour</b> Lichtfarbe	Ausstrahlungswinkel	Lebensdauer

**Q-INFO** | MOD 008x

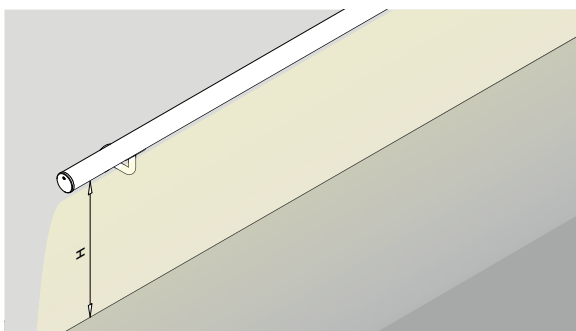

Lichtausbeute am Boden/auf den Treppenstufen

	Höhe (mm) des Fertigfußboden			
	900	1000	1100	1200
190080-300-30	165 lx	156 lx	146 lx	135 lx
190080-300-65	173 lx	163 lx	152 lx	141 lx
190082-300-30	154 lx	145 lx	136 lx	124 lx
190082-300-65	160 lx	150 lx	140 lx	128 lx

**Lux (lx) Erläuterung**

Direktes Sonnenlicht	= 100.000 lx	Flurbeleuchtung	= 100 lx
Tageslicht bei Bewölkung,	= 1.000 lx	Straßenbeleuchtung	= 10 lx
typisches Studiolicht		Kerzenlicht aus 1 m Entfernung	= 1 lx

Alle Angaben zur Lichtkalkulation sind ein Richtwert, da stets die vor Ort gegebenen räumlichen Anforderungen und gesetzlichen Rahmenbedingungen berücksichtigt werden müssen. Wir empfehlen, dass Sie einen Lichtarchitekten oder Elektroingenieur konsultieren, um die genauen Anforderungen für Ihr Projekt zu bestimmen.

Anschlusskabel für LED-Bänder, weiblich

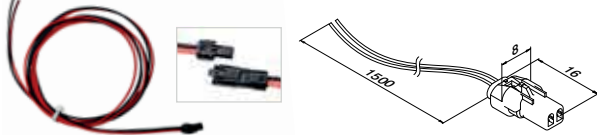

<b>MOD 0032</b>				
<b>OUTDOOR</b>	<b>V</b>	<b>L</b>		
200032-015-68	48	1500	1	

IP68

Silikon + Endkappen

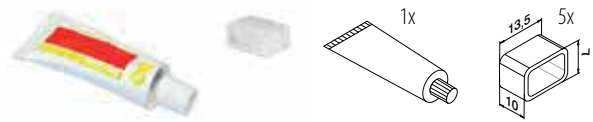

<b>MOD 0039</b>				
<b>OUTDOOR</b>				
200039			1	

Verbinder für LED-Bänder

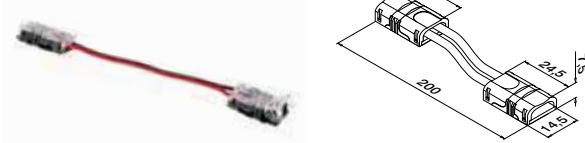

<b>MOD 0028</b>				
<b>INDOOR</b>				
200028			1	

IP20

Verbinder für LED-Bänder

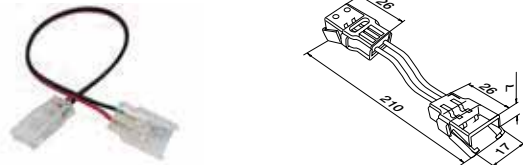

<b>MOD 0031</b>				
<b>OUTDOOR</b>				
200031			1	

IP66

Q-INFO MOD 0032

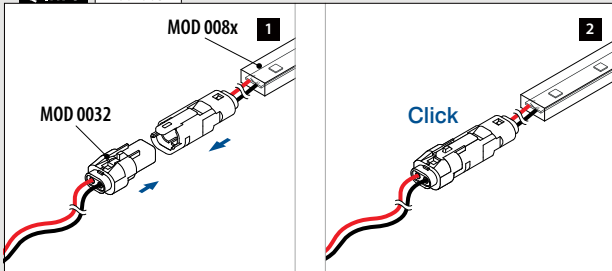

Q-INFO

INFORMATIONEN ZU DEN LED-BÄNDERN

- Alle LED-Bänder werden als Set geliefert, inklusive 1x MOD 0032 und 1x MOD 0039.
- Verwenden Sie für weitere Verbindungen den Kabelverbinder (MOD 0035, ■ 248) und die Verbindungskabel.

Q-INFO MOD 0028

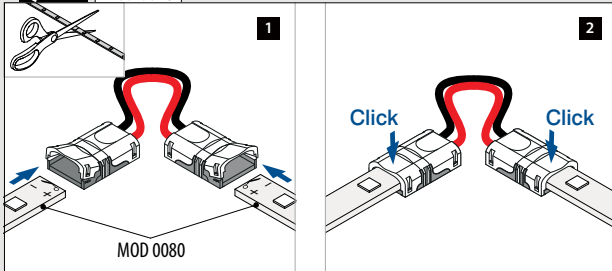

Q-INFO MOD 0031

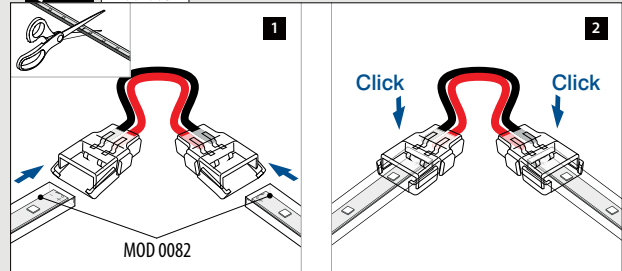

Q-INFO MOD 0039

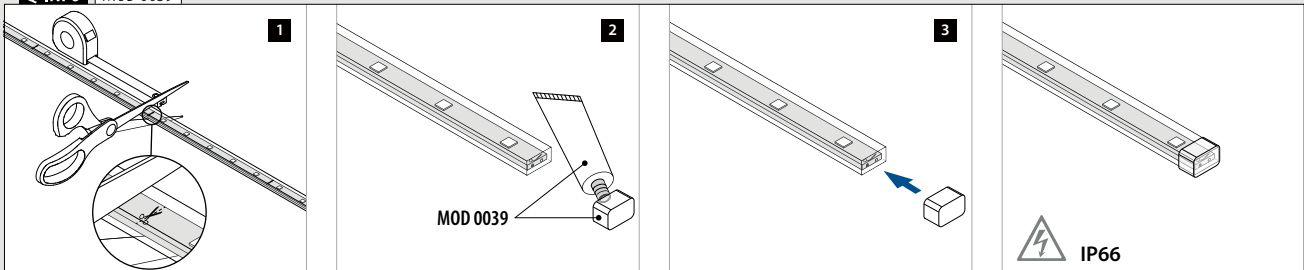

## Kabelverbinder, männlich-männlich

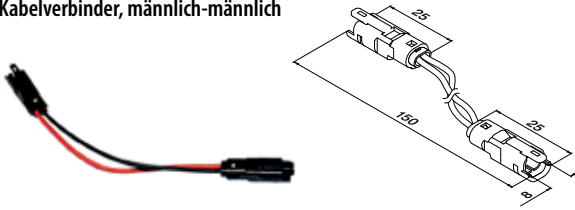

MOD 0035

OUTDOOR



200035

1

IP68

## Q-INFO | MOD 0035 / 0032 / 008x

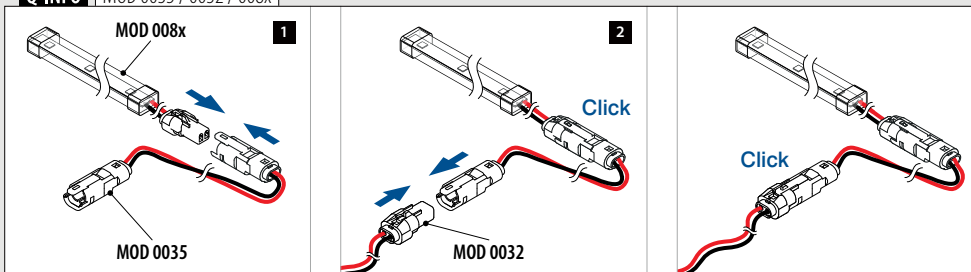

## Universalverbinder, Streifen zu Streifen



## MOD 0046

INDOOR	Für MOD	V	
200046-008	0070, 0071	24 / 48	1
200046-010	0080, 0090	24 / 48	1

**NEW** IP20

## Universal-Flex-Verbinder

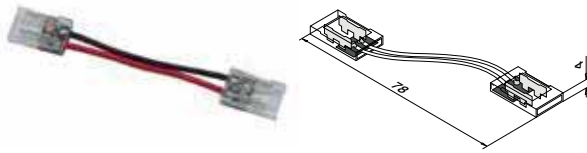

## MOD 0048

INDOOR	Für MOD	V	
200048-008	0070, 0071	24 / 48	1
200048-010	0080, 0090	24 / 48	1

**NEW** IP20

## Universal-Eckverbinder

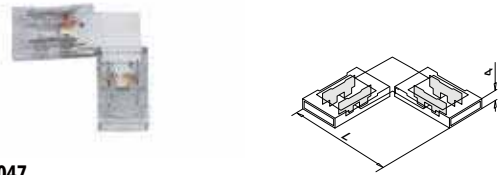

## MOD 0047

INDOOR	Für MOD	V	L	
200047-008	0070, 0071	24 / 48	25	1
200047-010	0080, 0090	24 / 48	30	1

**NEW** IP20

## Universal-Anschlusskabel

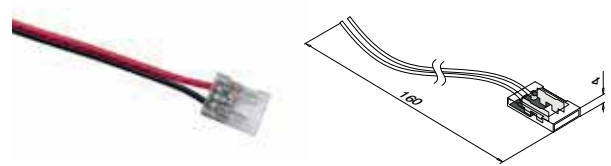

## MOD 0049

INDOOR	Für MOD	V	
200049-008	0070, 0071	24 / 48	1
200049-010	0080, 0090	24 / 48	1

**NEW** IP20

## Q-INFO MOD 0046

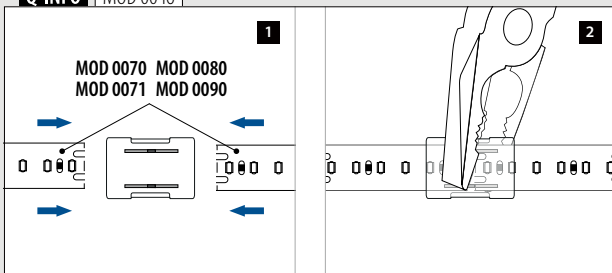

## Q-INFO MOD 0047

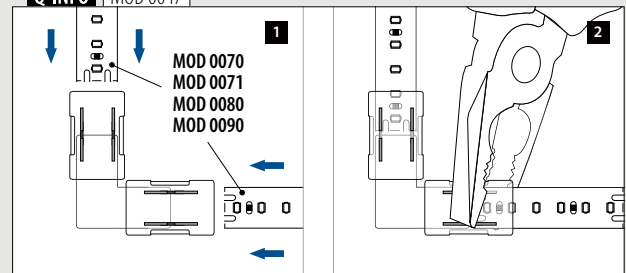

## Q-INFO MOD 0048

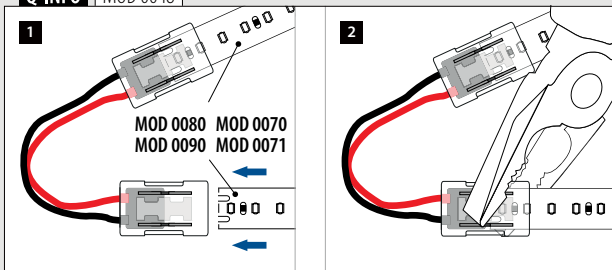

## Q-INFO MOD 0049

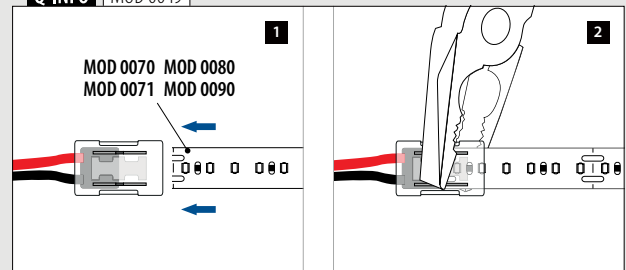



Universalverbinder, Streifen zu Streifen

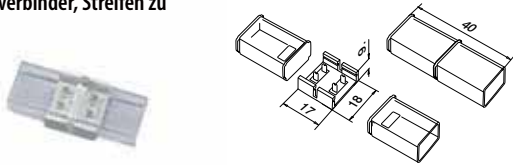

MOD 0053

OUTDOOR	Für MOD	V	
200053	0072, 0073, 0082, 0092	24 / 48	1

NEW IP68

Universal-Flex-Verbinder

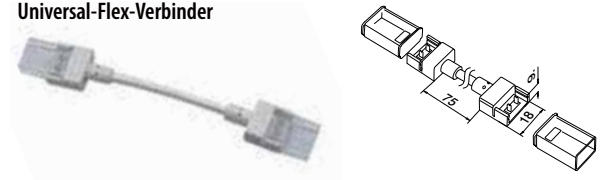

MOD 0054

OUTDOOR	Für MOD	V	
200054	0072, 0073, 0082, 0092	24 / 48	1

NEW IP68

Universal-Anschlusskabel

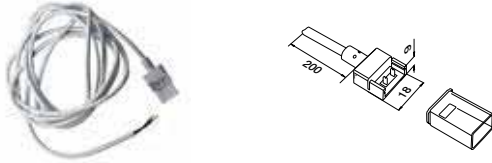

MOD 0055

OUTDOOR	Für MOD	V	
200055	0072, 0073, 0082, 0092	24 / 48	1

NEW IP68

MOD 0053 / 0054 / 0055

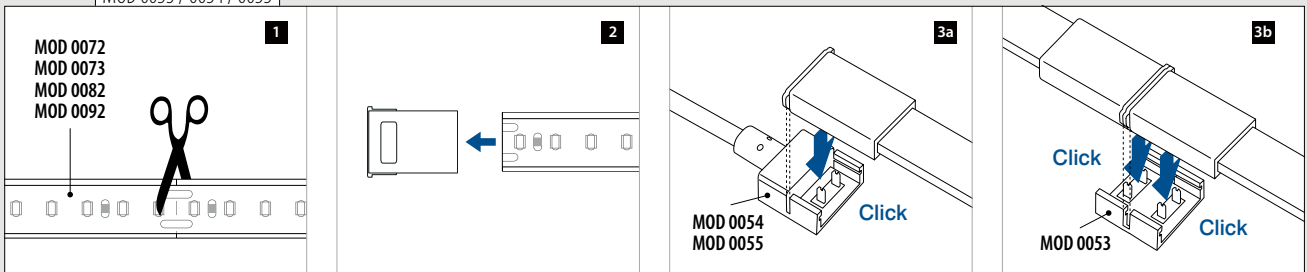

Q-INFO | MOD 008x

Indoor / outdoor

1

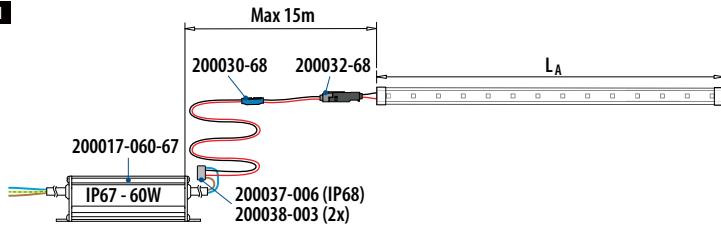

MOD 0080/0082  
L<sub>A</sub> ≤ 15,00 m

2

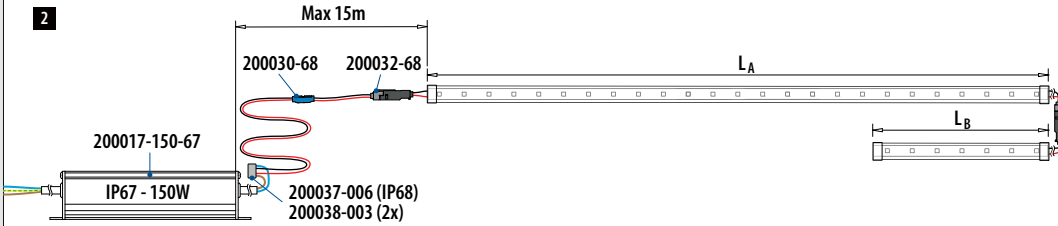

MOD 0080/0082  
L<sub>A</sub> + L<sub>B</sub> ≤ 38,00 m

3

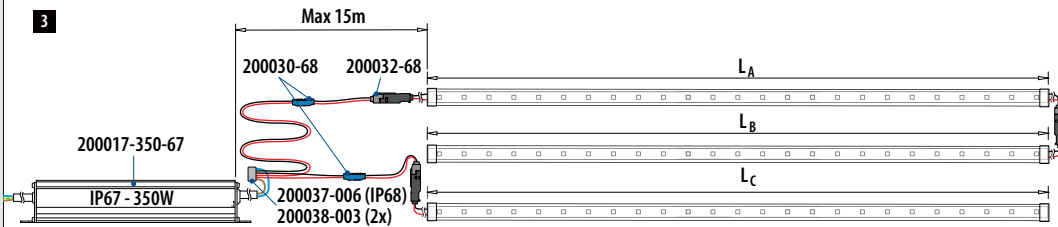

MOD 0080/0082  
L<sub>A</sub> + L<sub>B</sub> ≤ 60,00 m  
L<sub>C</sub> ≤ 30,00 m  
L<sub>A</sub> + L<sub>B</sub> + L<sub>C</sub> ≤ 90,00 m

4

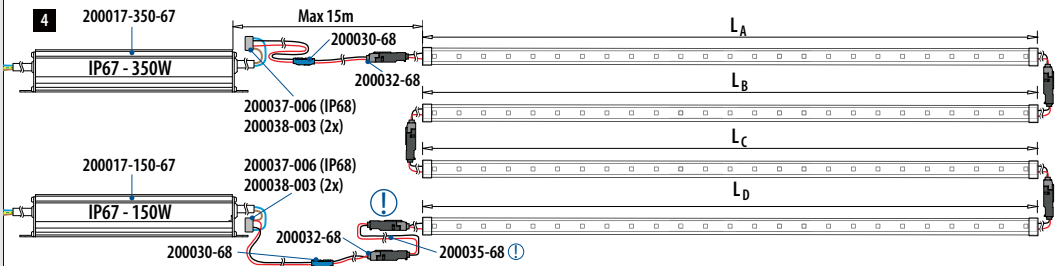

MOD 0080/0082  
L<sub>A</sub> + L<sub>B</sub> + L<sub>C</sub> + L<sub>D</sub> ≤ 120,00 m

Q-INFO | MOD 008x

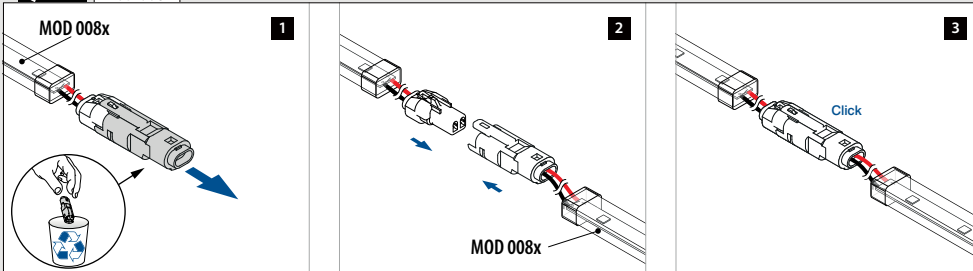

Q-INFO | MOD 0035 / 0032 / 008x

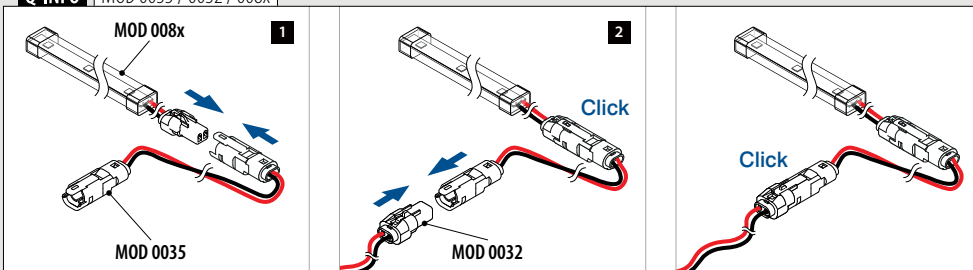

Steuerungsgerät für 12V und 24V

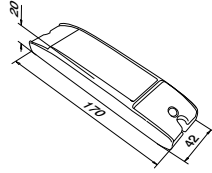

<b>MOD 0040</b>		
<b>INDOOR</b>		
200040		1

NEW

Steuerungsgerät für 24V und 48V

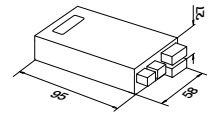

<b>MOD 0041</b>		
<b>INDOOR</b>		
200041		1

NEW



Kabel, schwarz

Halogenfrei, 145°C, für 12V, 24V und 48V, für den Außenbereich geeignet

<b>MOD 0012</b>		
<b>OUTDOOR</b>	$\emptyset$	
200012-001-01	1 mm <sup>2</sup>	L = 100 m
200012-003-01	2,5 mm <sup>2</sup>	L = 100 m

NEW



Kabel, rot

Halogenfrei, 145°C, für 12V, 24V und 48V, für den Außenbereich geeignet

<b>MOD 0012</b>		
<b>OUTDOOR</b>	$\emptyset$	
200012-001-02	1 mm <sup>2</sup>	L = 100 m
200012-003-02	2,5 mm <sup>2</sup>	L = 100 m

NEW

Q-INFO | MOD 0040

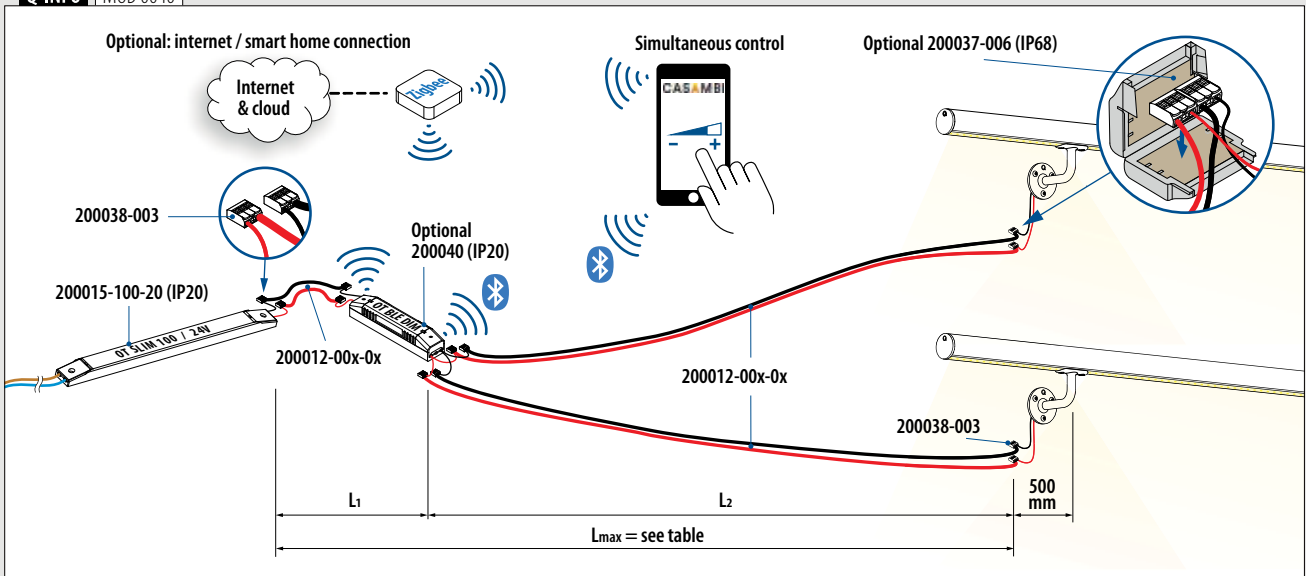

Q-INFO | MOD 0041

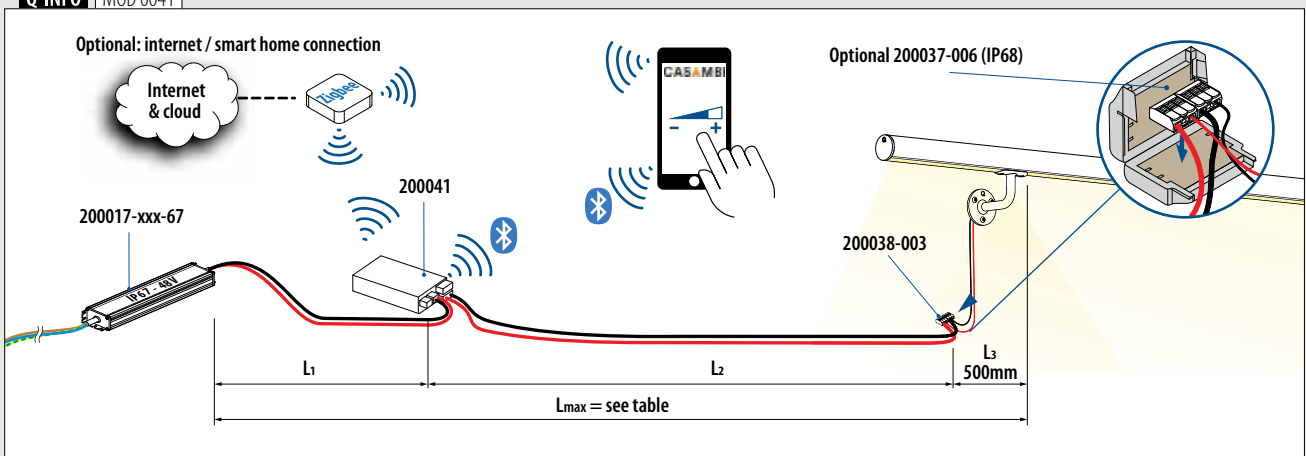

## Stromversorgung

## Kabelverbinder

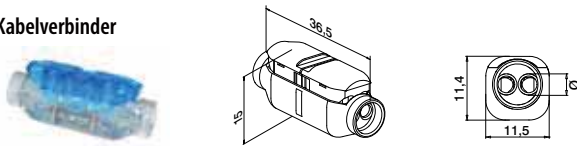

## MOD 0030

OUTDOOR	Ø	AWG	Box
200030-68	0,5 - 1 mm <sup>2</sup>	17 - 20	15

IP68

## Gelbox



## MOD 0037

OUTDOOR	Box
200037-006	1

IP68

## Kabelsplitter



## MOD 0038

INDOOR	Ø	Box
200038-003	0,14 - 4 mm <sup>2</sup>	12

IP20

## Q-INFO MOD 0030

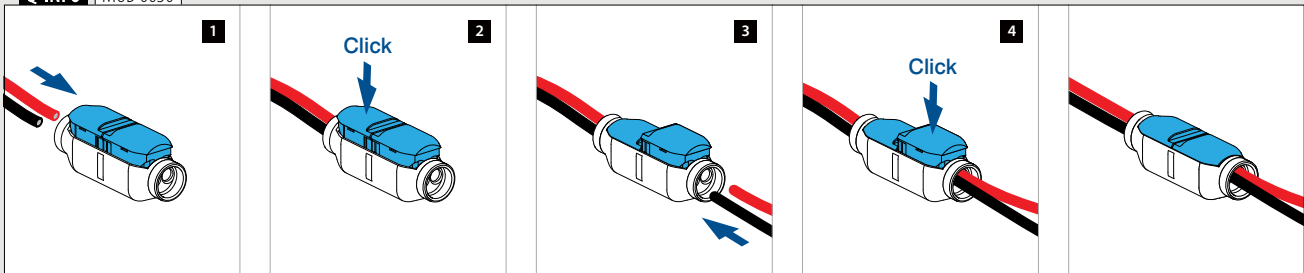

## Q-INFO MOD 0038

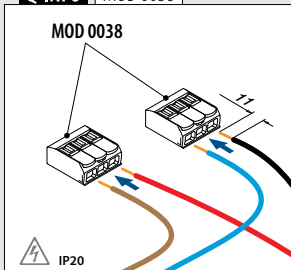

## Q-INFO MOD 0038

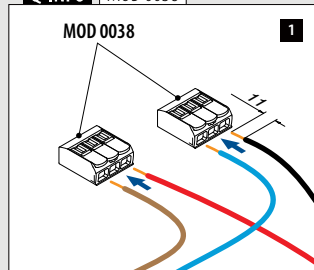

## Q-INFO MOD 0038

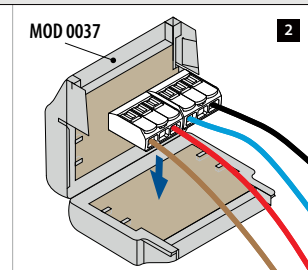

## Q-INFO MOD 0038

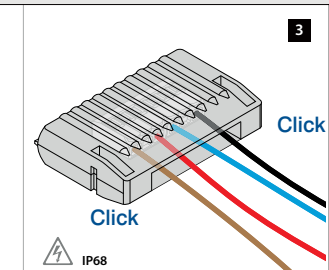

## Q-INFO MOD 0038

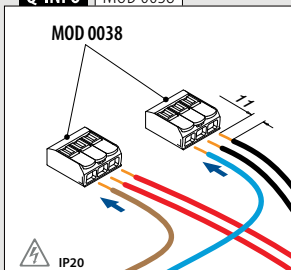

## Q-INFO MOD 0038

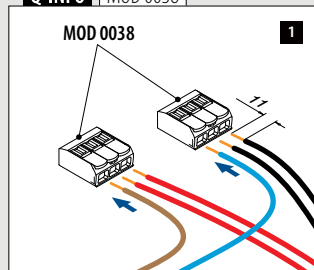

## Q-INFO MOD 0038

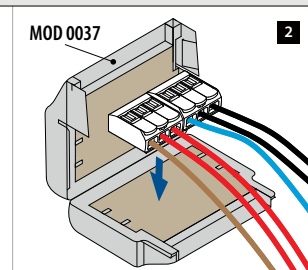

## Q-INFO MOD 0038

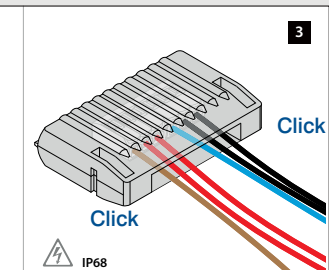

## Q-INFO

## SICHERHEITSHINWEISE

- Die Elektroinstallation von Netzmodulen darf nur unter Beachtung der gültigen lokalen Vorschriften und Normen durch eine zugelassene Elektrofachkraft erfolgen.
- Achten Sie bei der Inbetriebnahme auf die richtige Polung. Durch falsche Polung kann das Produkt beschädigt werden.
- Zum Betrieb sollten Netzgeräte verwendet werden, bei denen folgende Schutzmaßnahmen gewährleistet sein müssen:
  - Kurzschlusschutz
  - Überlastschutz
  - Übertemperaturschutz
  - Sicherheitskleinspannung SELV (Safety Extra Low Voltage)
- Beachten Sie die maximale Leistung der Ihnen zur Verfügung gestellten Stromversorgung.
- Nur die elektrische Parallelschaltung ermöglicht einen sicheren Betriebszustand.

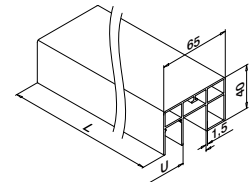
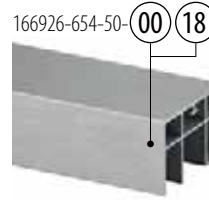
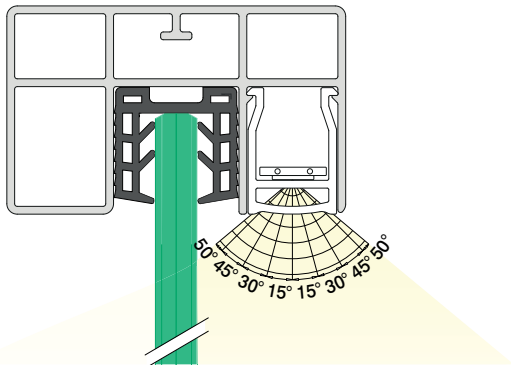

**MOD 6926**

<b>Aluminium</b> Roh	<b>U</b>	□	▢
166926-654-50-00	24	65 x 40	L = 5 m
<b>Aluminium</b> Gebürstet			
<b>OUTDOOR</b>			
166926-654-50-18	24	65 x 40	L = 5 m



Internationaler Geschmacksmusterschutz

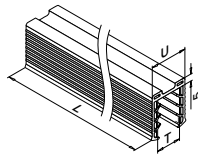

**MOD 5124**

**Zubehör**

U = 24 mm

Für monolithisches Glas	T	▢
205124-050-08	8 - 10	L = 5 m
205124-050-11	12	L = 5 m
205124-050-15	15	L = 5 m
205124-050-19	19	L = 5 m

Für laminiertes Glas

205124-050-08	8,76 - 10,76	L = 5 m
205124-050-11	11,52 - 13,52	L = 5 m
205124-050-17	16,76 - 17,52	L = 5 m
<b>NEW</b> 205124-050-92	20,76 - 21,52	L = 5 m

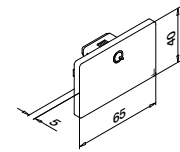

**MOD 6734 - EASY HIT®**

<b>Aluminium</b> Roh	<b>Für</b> □	▢
166734-654-00	65 x 40	2
<b>Aluminium</b> Gebürstet		
<b>OUTDOOR</b>		
166734-654-18	65 x 40	2

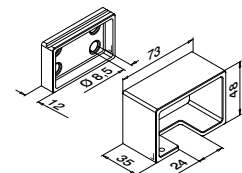

**MOD 6545**

<b>Aluminium</b> Roh	<b>Für</b> □	⚙️	▢
166545-654-00	65 x 40	QS-55 ▢472 / QS-20 ▢474	2
<b>Aluminium</b> Gebürstet			
<b>OUTDOOR</b>			
166545-654-18	65 x 40	QS-55 ▢472 / QS-20 ▢474	2



Internationaler Geschmacksmusterschutz

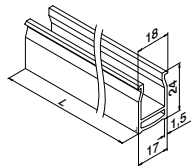

**MOD 5091**

<b>INDOOR</b>	<b>Transparenz</b>	▢
155091-025-03	Klar	L = 2,5 m
155091-025-06	Diffus	L = 2,5 m



Internationaler Geschmacksmusterschutz

**Q-INFO** | MOD 6545 / 5124 / 6926

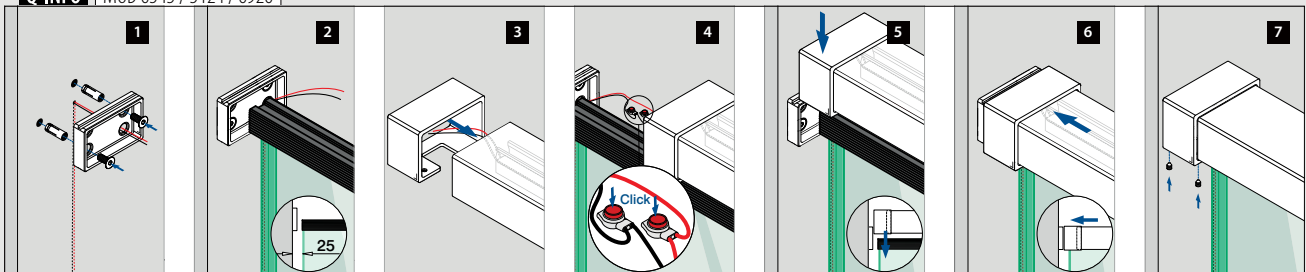



Verbinder

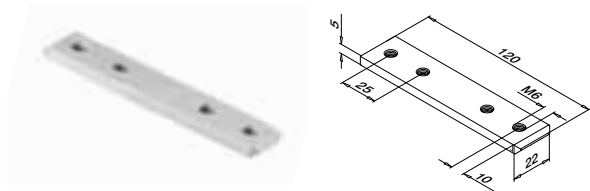

**MOD 6795**

<b>Aluminium</b>	Roh		
166795-339	QS-261	474	2

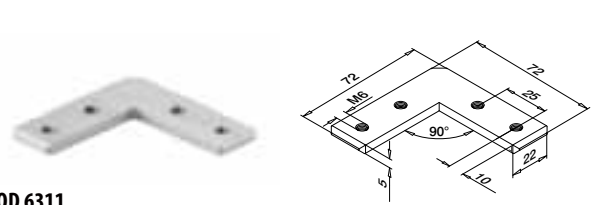

**MOD 6311**

<b>Aluminium</b>	Roh		
166311-339	QS-261	474	2

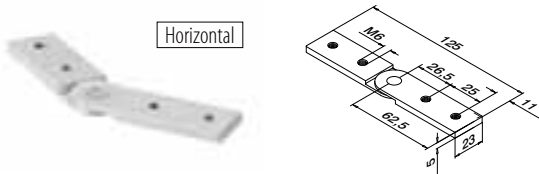

**MOD 6797**

<b>Aluminium</b>	Roh		
166797	QS-261	474	2

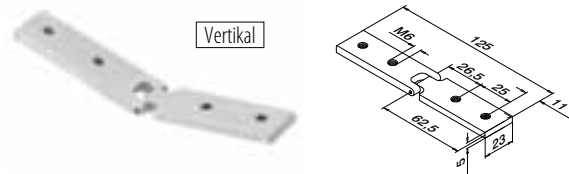

**MOD 6798**

<b>Aluminium</b>	Roh		
166798	QS-261	474	2

**Q-INFO** MOD 6311

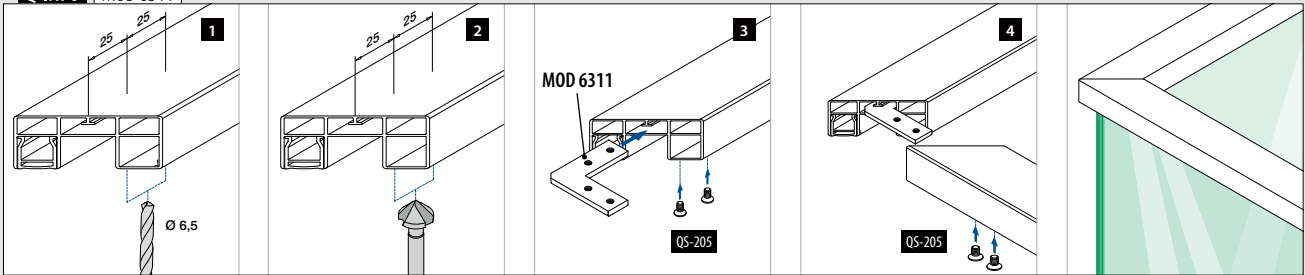

**Q-INFO** MOD 6797

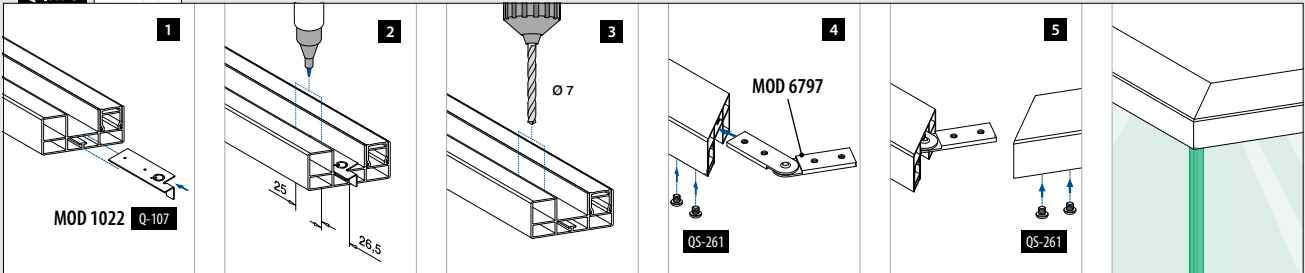

**Q-INFO** MOD 6798

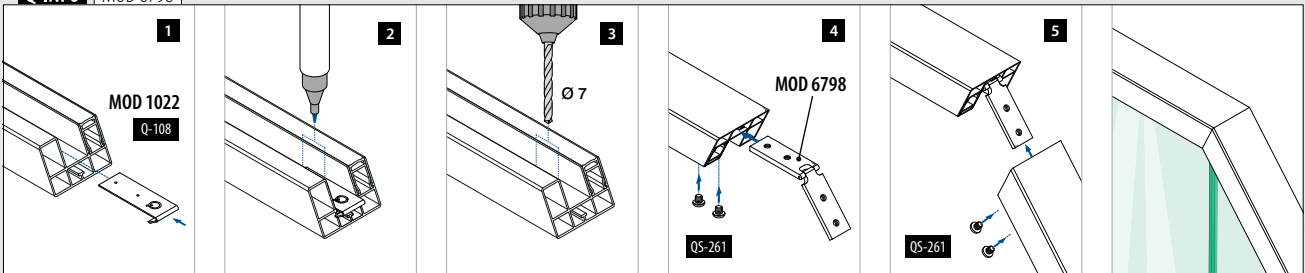

**Q-INFO** MOD 6798

**Nach oben**

Schneiden	45°	40°	35°	30°	25°	20°	15°	10°	5°	0°
Außenwinkel	90°	100°	110°	120°	130°	140°	150°	160°	170°	180°
Abstand zum Rand (x)	30,5	30,0	29,5	29,0	28,5	28,0	27,5	27,0	27,0	26,5

**Nach unten**

Schneiden	0°	5°	10°	15°	20°	25°	30°	35°	40°	45°
Innenwinkel	180°	170°	160°	150°	140°	130°	120°	110°	100°	90°
Abstand zum Rand (x)	26,5	26,5	26,0	26,0	25,5	25,5	25,0	24,5	24,5	24,0

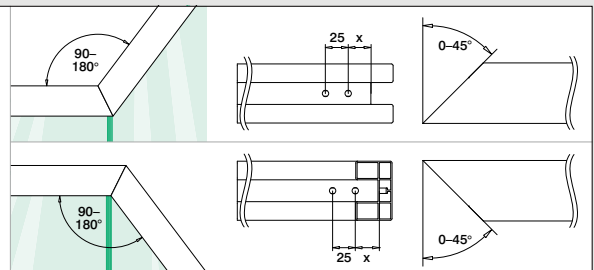

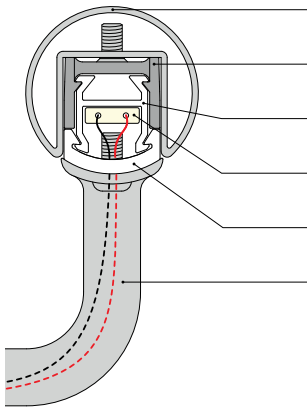

- Glasleistenrohre (U = 24): ■ 257
- Adapter MOD 078x-24: ■ 256
- Trägerprofil: ■ 257
- LED-Bänder: ■ 238, 245
- Abdeckprofil für LED-Bänder: ■ 257
- Handlaufstützen: ■ 260 - 261
- Handlaufadapter MOD 0770 / 0772: ■ 262

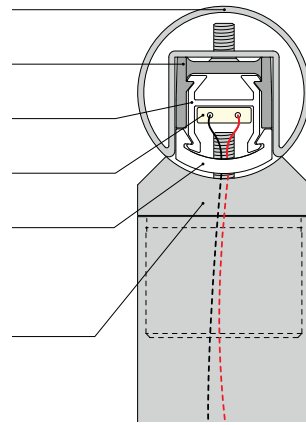

Für Handlaufstützen, fix

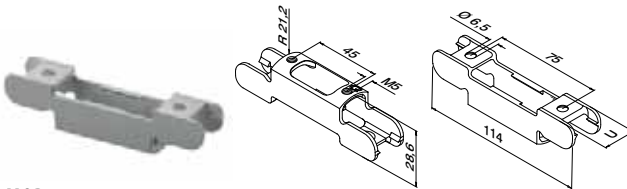

**MOD 0781**

V4A	316	Gebürstet		
	<b>OUTDOOR</b>	<b>U</b>		
140781-24	24	QS-205 ■ 474	2	

Internationaler Geschmacksmusterschutz

Für Handlaufstützen, justierbar

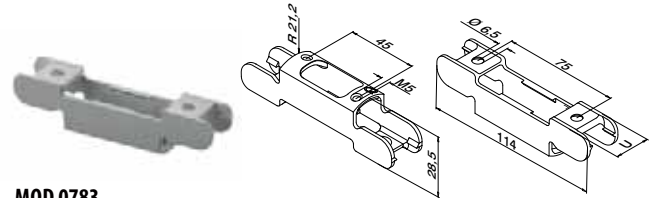

**MOD 0783**

V4A	316	Gebürstet		
	<b>OUTDOOR</b>	<b>U</b>		
140783-24	24	QS-205 ■ 474	2	

Internationaler Geschmacksmusterschutz

Für Handlaufadapter, fix

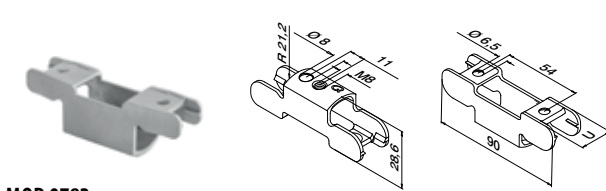

**MOD 0782**

V4A	316	Gebürstet		
	<b>OUTDOOR</b>	<b>U</b>		
140782-24	24	QS-205 ■ 474	2	

Internationaler Geschmacksmusterschutz



**MOD 0780**

V4A	316	Gebürstet		
	<b>OUTDOOR</b>	<b>U</b>		
140780-24	24	QS-205 ■ 474	2	

Internationaler Geschmacksmusterschutz

**Q-INFO** | MOD 0780 / 0781

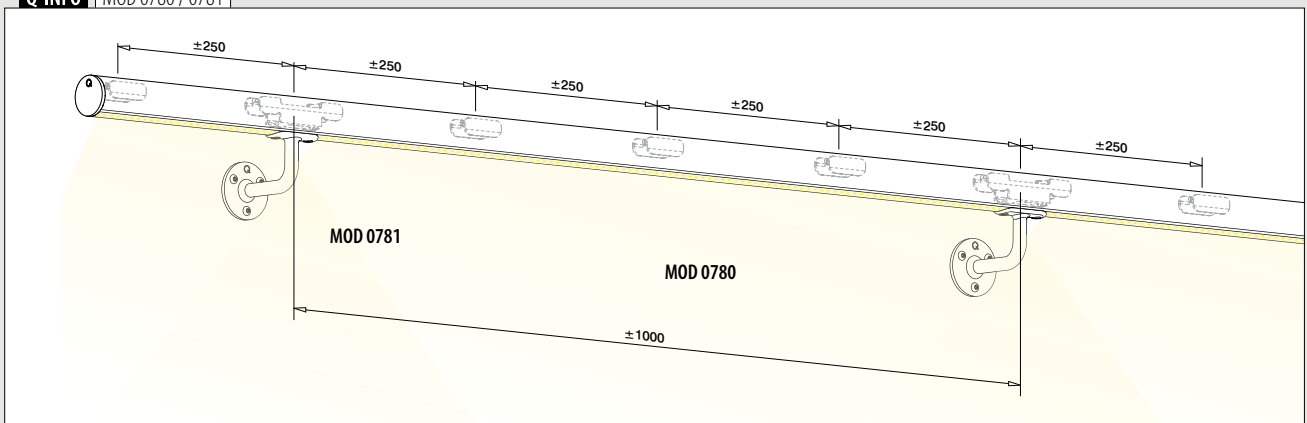

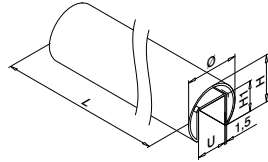

**MOD 6920**

Ø 42,4 mm

<b>V2A</b>	<b>304</b>	Gebürstet				
<b>INDOOR</b>			<b>U</b>	<b>Ø</b>	<b>H</b>	<b>H1</b>
136920-042-50-12			24	42,4	37	24
						L = 5 m

<b>V4A</b>	<b>316</b>	Gebürstet				
<b>OUTDOOR</b>			<b>U</b>	<b>Ø</b>	<b>H</b>	<b>H1</b>
146920-042-50-12			24	42,4	37	24
						L = 5 m

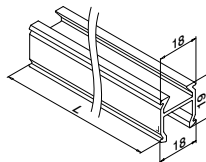

**MOD 5092**

**INDOOR**

155092-025

L = 2,5 m

Internationaler Geschmacksmusterschutz

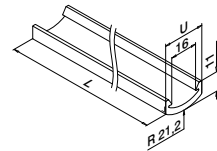

**MOD 5090**

**INDOOR**

**Transparenz**

155090-025-24-03

Klar

L = 2,5 m

155090-025-24-06

Diffus

L = 2,5 m

IK10

Internationaler Geschmacksmusterschutz

**Q-INFO** MOD 6920

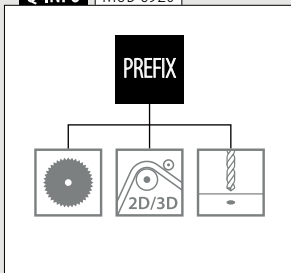

**MOD 6950**  
(U = 24 mm)  
169

**MOD 6924**  
(U = 24 mm)  
176 - 182

**Q-INFO** MOD 078x

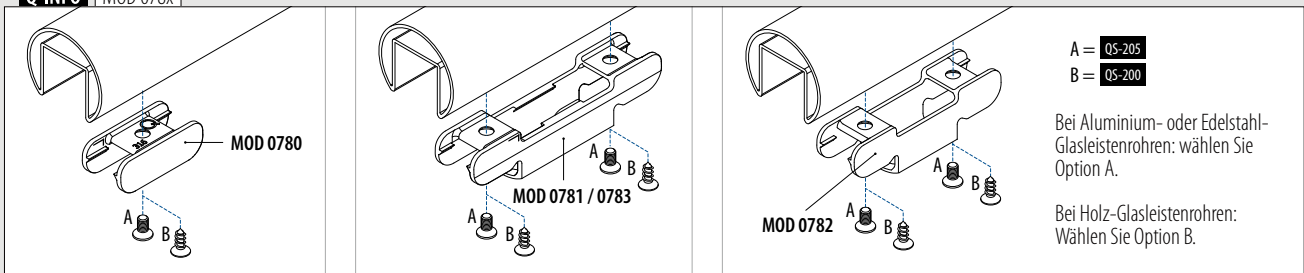

**Q-INFO** MOD 0783

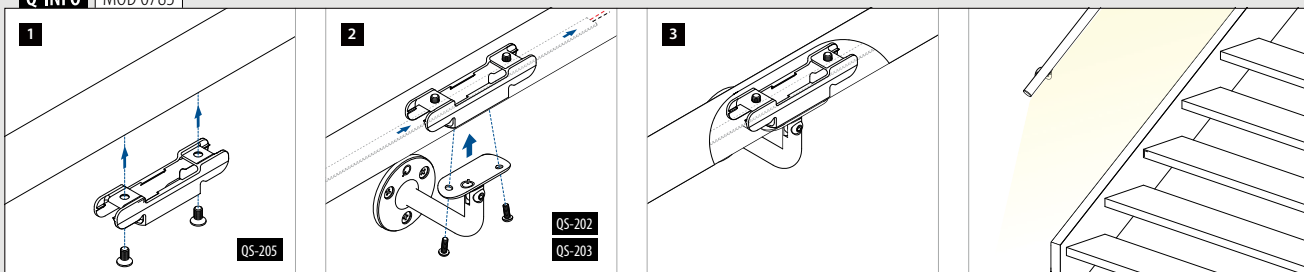

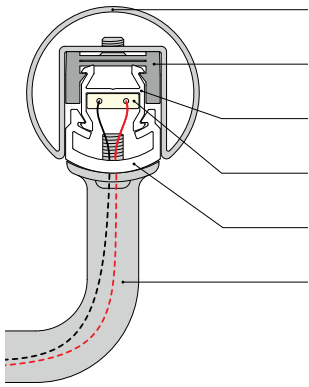

Glasleitenrohre (U = 27): 259

Adapter MOD 078x-27: 258

Trägerprofil: 259

LED-Bänder: 238, 245

Abdeckprofil für LED-Bänder: 259

Handlaufstützen: 260 - 261

Handlaufadapter MOD 0771 / 0773:  
262

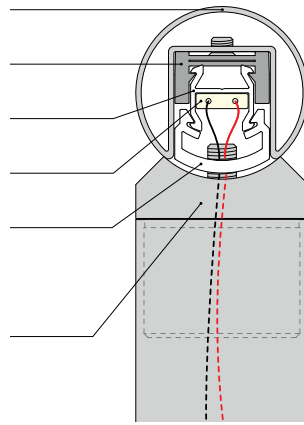

Für Handlaufstützen, fix

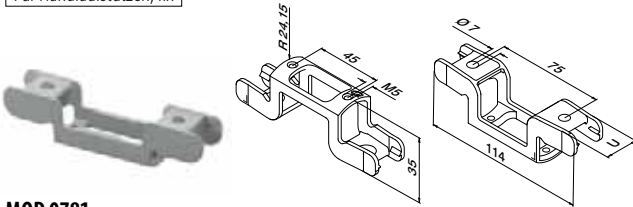

**MOD 0781**

V4A	316	Gebürstet		
	<b>OUTDOOR</b>	<b>U</b>		
140781-27	27	QS-205 474	2	

Internationaler Geschmacksmusterschutz

Für Handlaufstützen, justierbar

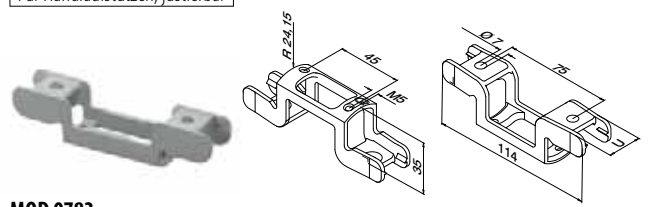

**MOD 0783**

V4A	316	Gebürstet		
	<b>OUTDOOR</b>	<b>U</b>		
140783-27	27	QS-205 474	2	

Internationaler Geschmacksmusterschutz

Für Handlaufadapter, fix

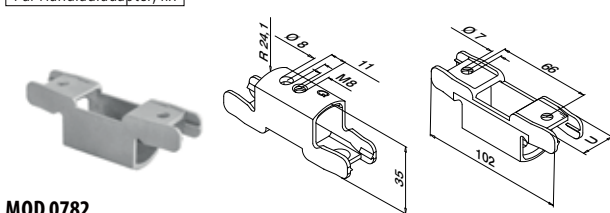

**MOD 0782**

V4A	316	Gebürstet		
	<b>OUTDOOR</b>	<b>U</b>		
140782-27	27	QS-205 474	2	

Internationaler Geschmacksmusterschutz



**MOD 0780**

V4A	316	Gebürstet		
	<b>OUTDOOR</b>	<b>U</b>		
140780-27	27	QS-205 474	2	

Internationaler Geschmacksmusterschutz

**Q-INFO** | MOD 0780 / 0781

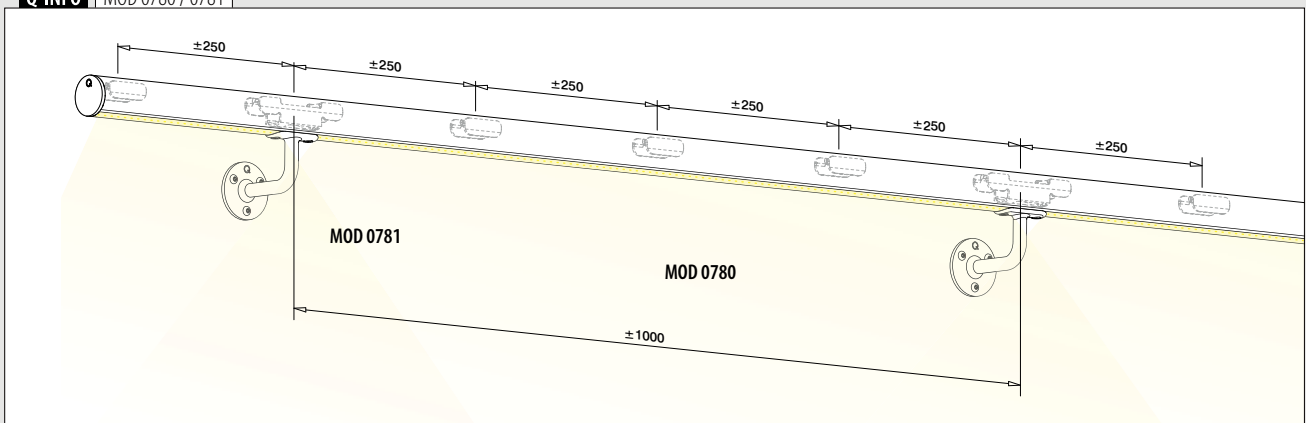

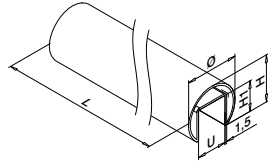

**MOD 6920**

Ø 48,3 mm

<b>V2A</b>	<b>304</b>	Gebürstet				
<b>INDOOR</b>			<b>U</b>	<b>U</b>	<b>H</b>	<b>H1</b>
136920-048-50-12			27	48,3	42,6	30
						L = 5 m

<b>V4A</b>	<b>316</b>	Gebürstet				
<b>OUTDOOR</b>			<b>U</b>	<b>U</b>	<b>H</b>	<b>H1</b>
146920-048-50-12			27	48,3	42,6	30
						L = 5 m

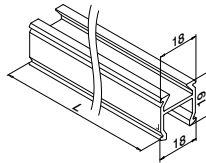

**MOD 5092**

**INDOOR**

155092-025

L = 2,5 m

Internationaler Geschmacksmusterschutz

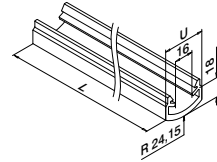

**MOD 5090**

**INDOOR**

**Transparenz**

155090-025-27-03

Klar

L = 2,5 m

155090-025-27-06

Diffus

L = 2,5 m

IK10

Internationaler Geschmacksmusterschutz

**Q-INFO** MOD 078x

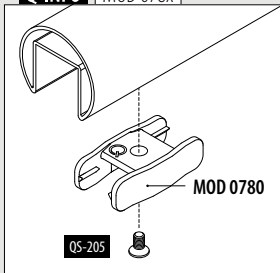

**MOD 0781 / 0783**

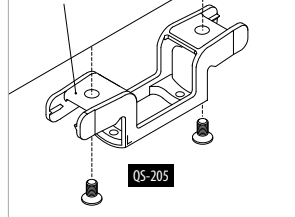

**MOD 0782**

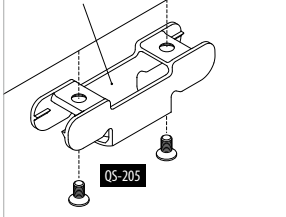

**Q-INFO** MOD 6920

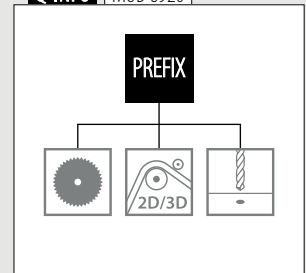

**Q-INFO** MOD 0783

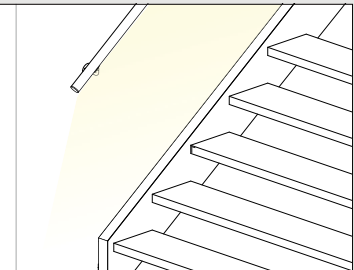
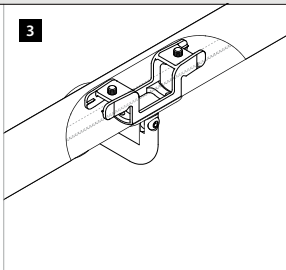
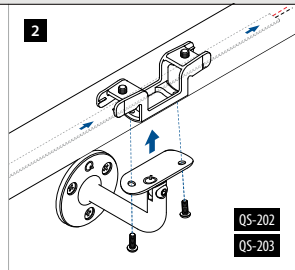
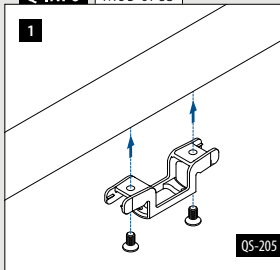





Für rundes Rohr

Mit Kabelkanal

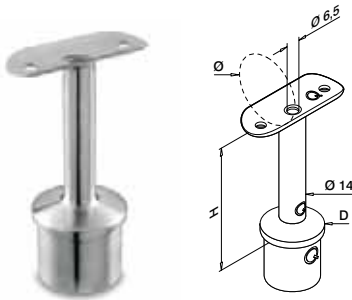

## MOD 0710

V4A	316	Gebürstet					
OUTDOOR			D	Ø	H		
140710-042-01-12	42,4 x 2,0	42,4	MOD 0781-24	79	QS-203 474	2	

## MOD 0711

V4A	316	Gebürstet					
OUTDOOR			D	Ø	H		
140711-048-01-12	48,3 x 2,0	48,3	MOD 0781-27	80	QS-203 474	2	



Für rundes Rohr

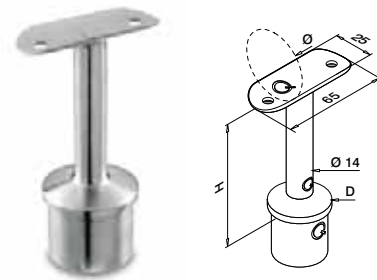

## MOD 0710

V2A	304	Gebürstet					
INDOOR			D	Ø	H		
130710-042-00-12	42,4 x 2,0	42,4	MOD 0781-24	79	QS-202 474	2	

V4A 316 Gebürstet  
OUTDOOR

140710-042-00-12	42,4 x 2,0	42,4	MOD 0781-24	79	QS-203 474	2	
------------------	------------	------	-------------	----	---------------	---	--

## MOD 0711

V2A	304	Gebürstet					
INDOOR			D	Ø	H		
130711-048-00-12	48,3 x 2,0	48,3	MOD 0781-27	80	QS-202 474	2	

V4A 316 Gebürstet  
OUTDOOR

140711-048-00-12	48,3 x 2,0	48,3	MOD 0781-27	80	QS-203 474	2	
------------------	------------	------	-------------	----	---------------	---	--



Für rundes Rohr

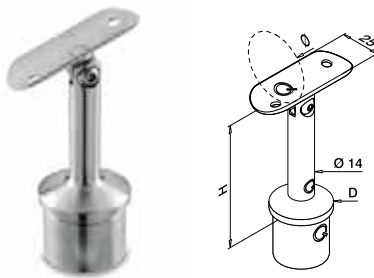

## MOD 0718

V2A	304	Gebürstet					
INDOOR			D	Ø	H		
130718-042-12	42,4 x 2,0	42,4	MOD 0783-24	79	QS-202 474	2	

V4A 316 Gebürstet  
OUTDOOR

140718-042-12	42,4 x 2,0	42,4	MOD 0783-24	79	QS-203 474	2	
---------------	------------	------	-------------	----	---------------	---	--

## MOD 0719

V2A	304	Gebürstet					
INDOOR			D	Ø	H		
130719-048-12	48,3 x 2,0	48,3	MOD 0783-27	80	QS-202 474	2	

V4A 316 Gebürstet  
OUTDOOR

140719-048-12	48,3 x 2,0	48,3	MOD 0783-27	80	QS-203 474	2	
---------------	------------	------	-------------	----	---------------	---	--

## Q-INFO MOD 0710 / 0711-04x-01

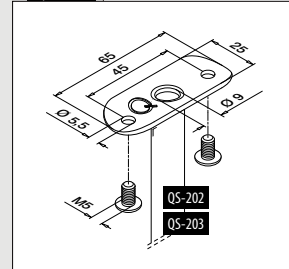

## Q-INFO MOD 0710 / 0711-04x-00

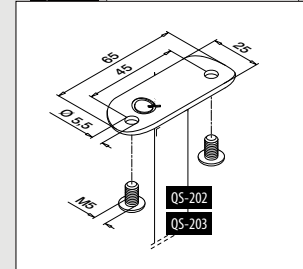

## Q-INFO MOD 0710 / 0711-04x-01

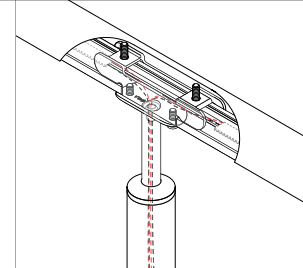
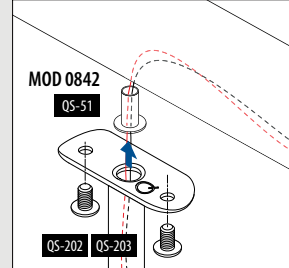

## Q-INFO MOD 0710 / 0711-04x-01

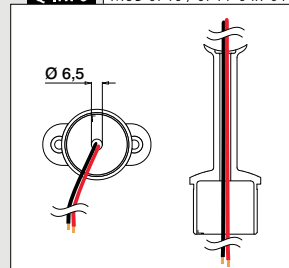

## Q-INFO MOD 0718 / 0719

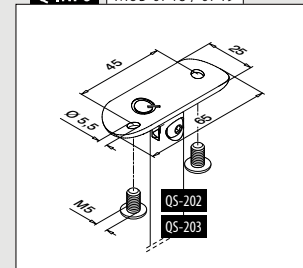

Mit Kabelkanal

Für rundes Rohr

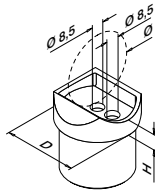

## MOD 0770

V2A	304	Gebürstet						
INDOOR			D	Ø	H	Ø	Q	Q
130770-042-12	42,4 x 2,0	42,4	MOD 0782-24	9	QS-26	474	2	

V4A	316	Gebürstet						
OUTDOOR			D	Ø	H	Ø	Q	Q
140770-042-12	42,4 x 2,0	42,4	MOD 0782-24	9	QS-27	474	2	

## MOD 0772

V2A	304	Gebürstet						
INDOOR			D	Ø	H	Ø	Q	Q
SELL OUT 130772-042-12	42,4 x 2,6	42,4	MOD 0782-24	9	QS-26	474	2	

V4A	316	Gebürstet						
OUTDOOR			D	Ø	H	Ø	Q	Q
SELL OUT 140772-042-12	42,4 x 2,6	42,4	MOD 0782-24	9	QS-27	474	2	

## MOD 0771

V2A	304	Gebürstet						
INDOOR			D	Ø	H	Ø	Q	Q
130771-048-12	48,3 x 2,0	48,3	MOD 0782-27	11	QS-26	474	2	

V4A	316	Gebürstet						
OUTDOOR			D	Ø	H	Ø	Q	Q
140771-048-12	48,3 x 2,0	48,3	MOD 0782-27	11	QS-27	474	2	

## MOD 0773

V2A	304	Gebürstet						
INDOOR			D	Ø	H	Ø	Q	Q
130773-048-12	48,3 x 2,6	48,3	MOD 0782-27	11	QS-26	474	2	

V4A	316	Gebürstet						
OUTDOOR			D	Ø	H	Ø	Q	Q
140773-048-12	48,3 x 2,6	48,3	MOD 0782-27	11	QS-27	474	2	



Internationaler Geschmacksmusterschutz

SELL OUT Nur solange der Vorrat reicht.

## Q-INFO

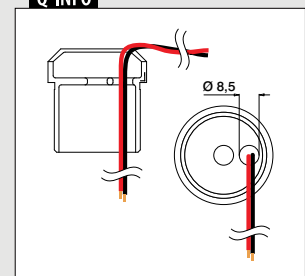
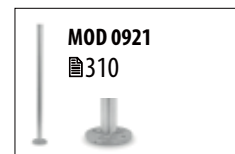

## Q-INFO

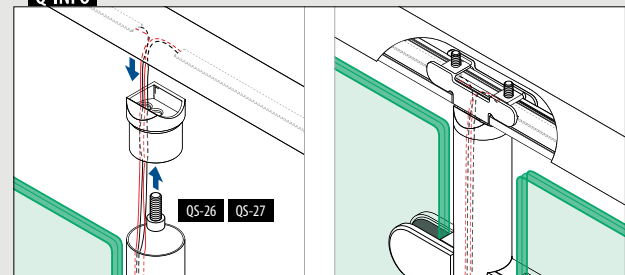

## Q-INFO

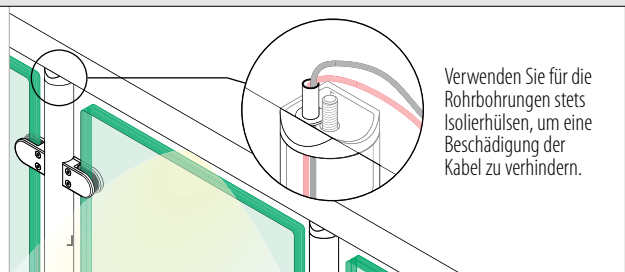
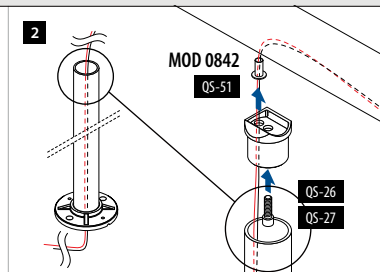
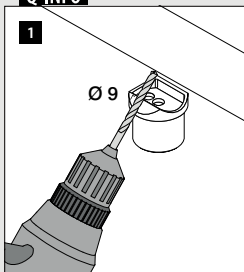

## Glasleistenrohre

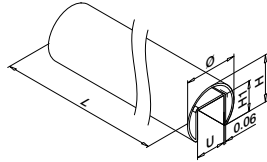

## MOD 6920

Ø 42,4 mm

V2A	304	Gebürstet				
INDOOR		U	H	H1		
136920-042-50-12	24	37	24		L = 5 m	

V4A	316	Gebürstet				
OUTDOOR		U	H	H1		
146920-042-50-12	24	37	24		L = 5 m	

Ø 48,3 mm

V2A	304	Gebürstet				
INDOOR		U	H	H1		
136920-048-50-12	27	42,6	30		L = 5 m	

V4A	316	Gebürstet				
OUTDOOR		U	H	H1		
146920-048-50-12	27	42,6	30		L = 5 m	

PREFIX



## Glasleistenrohr/Pfosten-Verbinder

Justierbar

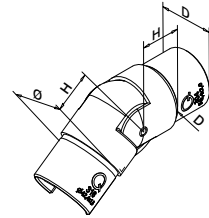

## MOD 6304

V4A	316	Gebürstet				
OUTDOOR		Ø	D	H		
146304-242-01-12	42,4 x 1,5	42,4 x 2,0	27		2	
146304-248-01-12	48,3 x 1,5	48,3 x 2,0	30		2	
146304-048-01-12	48,3 x 1,5	48,3 x 2,6	30		2	

NEW

## Glasleistenrohr/Rohr-Verbinder

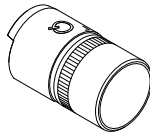
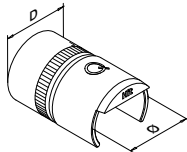

## MOD 5793 - EASY HIT®

V4A	316	Roh				
OUTDOOR		Für Rohr Ø	Für Rohr D			
145793-042	42,4 x 1,5	42,4 x 2,0	2			
145793-048	48,3 x 1,5	48,3 x 2,0	2			



Internationaler Geschmacksmusterschutz

## Q-INFO MOD 6304

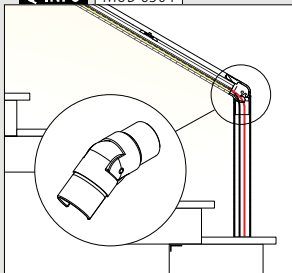

## Q-INFO MOD 5793

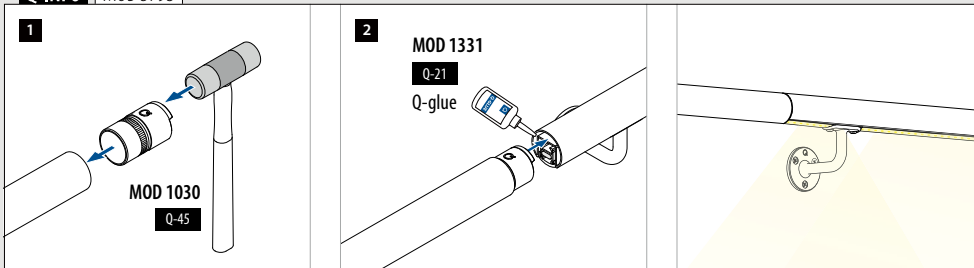

## Q-INFO MOD 6920

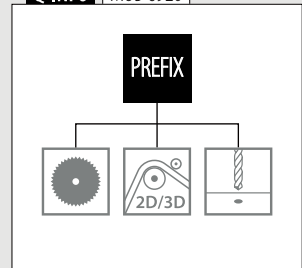

## Verbinder

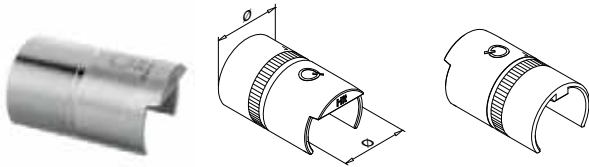

## MOD 6792 - EASY HIT®

V2A	304	Roh			
INDOOR			Für Ø		
136792-042			42,4 x 1,5		2
136792-048			48,3 x 1,5		2
V4A	316	Roh			
OUTDOOR					
146792-042			42,4 x 1,5		2
146792-048			48,3 x 1,5		2



## MOD 6313

V2A	304	Gebürstet			
INDOOR			Für Ø	H	
136313-042-12			42,4 x 1,5	30	2
136313-048-12			48,3 x 1,5	35	2
V4A	316	Gebürstet			
OUTDOOR					
146313-042-12			42,4 x 1,5	30	2
146313-048-12			48,3 x 1,5	35	2



## Verbinder

Justierbar



## MOD 6302

V2A	304	Gebürstet			
INDOOR			Für Ø	H	
136302-042-02-12			42,4 x 1,5	30	2
136302-048-02-12			48,3 x 1,5	35	2
V4A	316	Gebürstet			
OUTDOOR					
146302-042-02-12			42,4 x 1,5	30	2
146302-048-02-12			48,3 x 1,5	35	2



## MOD 6302

V2A	304	Gebürstet			
INDOOR			Für Ø	H	
136302-042-01-12			42,4 x 1,5	30	2
136302-048-01-12			48,3 x 1,5	35	2
V4A	316	Gebürstet			
OUTDOOR					
146302-042-01-12			42,4 x 1,5	30	2
146302-048-01-12			48,3 x 1,5	35	2



## MOD 6312

V2A	304	Gebürstet			
INDOOR			Ø	H	
136312-042-12			42,4 x 1,5	27	2
136312-048-12			48,3 x 1,5	30	2
V4A	316	Gebürstet			
OUTDOOR					
146312-042-12			42,4 x 1,5	27	2
146312-048-12			48,3 x 1,5	30	2



NEW

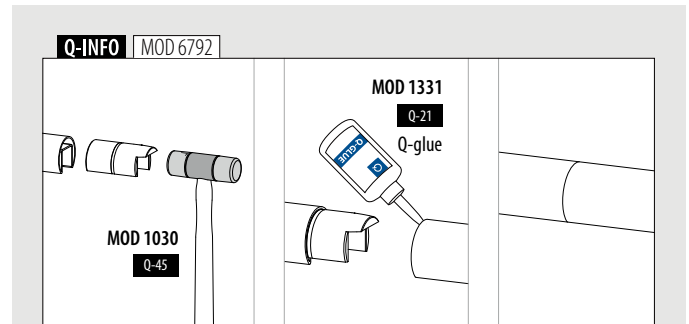



## Endkappen



## MOD 6732

V2A	304	Gebürstet			
INDOOR			Für Ø		
136732-042-12			42,4 x 1,5		2
136732-048-12			48,3 x 1,5		2
V4A	316	Gebürstet			
OUTDOOR			Für Ø		
146732-042-12			42,4 x 1,5		2
146732-048-12			48,3 x 1,5		2



## Endbögen zur Wand

Links / rechts

Mit Kabelkanal

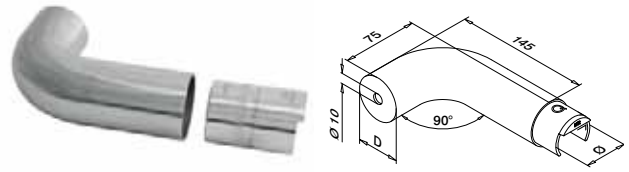

## MOD 6739

V4A	316	Gebürstet			
OUTDOOR			D	Für Ø	
146739-042-12			42,4	42,4 x 1,5	2
146739-048-12			48,3	48,3 x 1,5	2



## Wandflansche

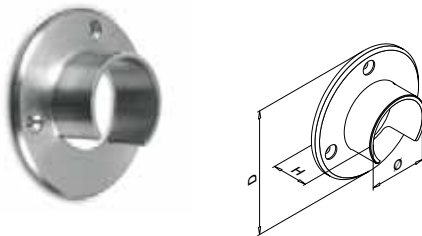

## MOD 6505

V2A	304	Gebürstet					
INDOOR			Ø	D	H		
136505-042-12			42,4	90	30	QS-5 473	2
136505-048-12			48,3	95	35	QS-5 473	2
V4A	316	Gebürstet					
OUTDOOR			Ø	D	H		
146505-042-12			42,4	90	30	QS-6 473	2
146505-048-12			48,3	95	35	QS-6 473	2



Mit Kabelkanal

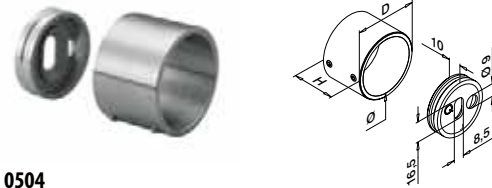

## MOD 0504

V2A	304	Gebürstet					
INDOOR			Ø	D	H		
130504-042-12			42,4	50	35	QS-55 472 / QS-21 474	2
130504-048-12			48,3	56	35	QS-55 472 / QS-21 474	2
V4A	316	Gebürstet					
OUTDOOR			Ø	D	H		
140504-042-12			42,4	50	35	QS-55 472 / QS-22 474	2
140504-048-12			48,3	56	35	QS-55 472 / QS-22 474	2



## Q-INFO MOD 6739

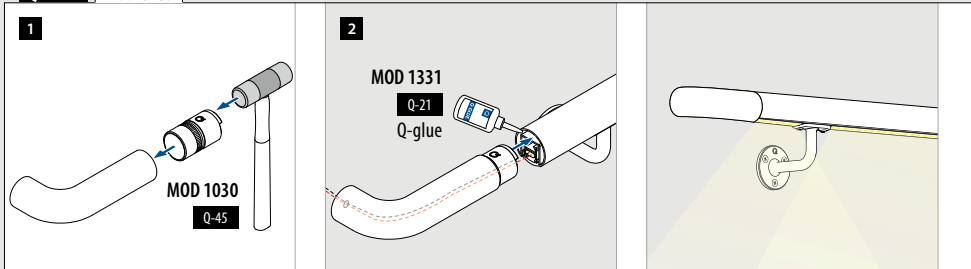

## Q-INFO MOD 6739

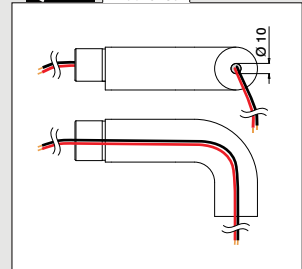

## Q-INFO MOD 0504

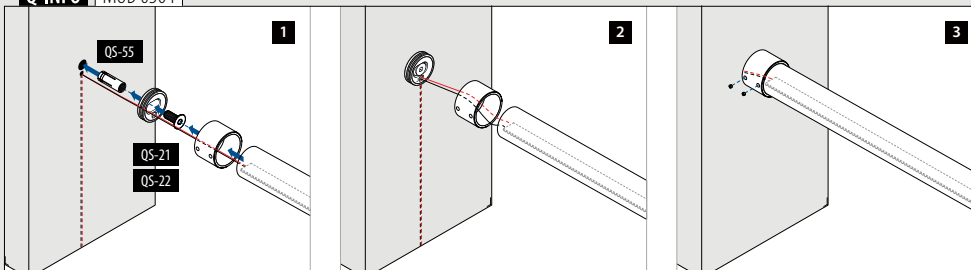

## Q-INFO MOD 0504

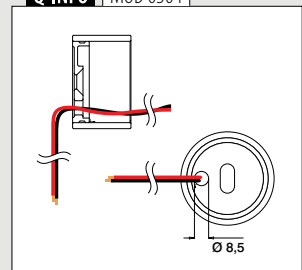

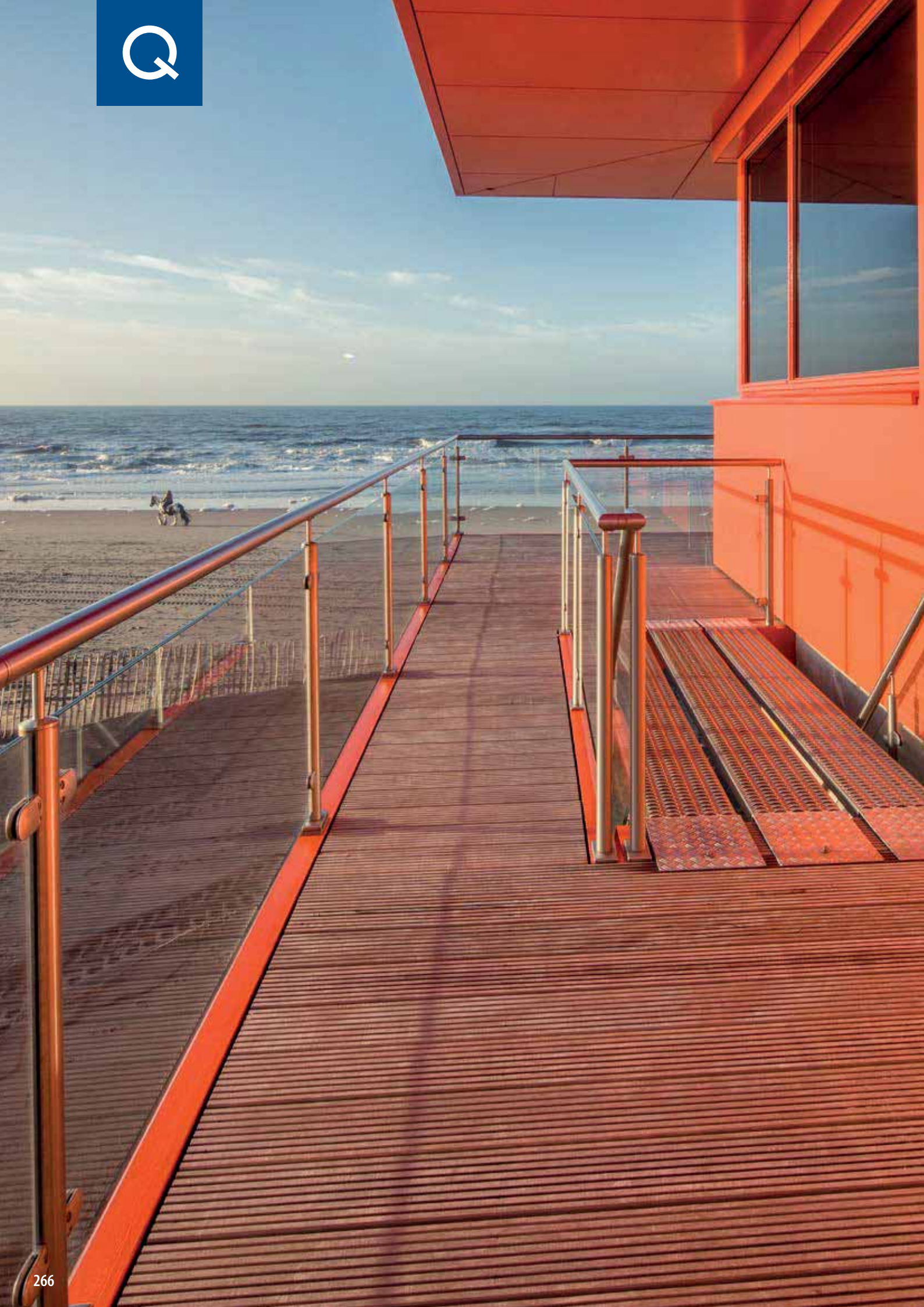

# PFOSTEN- GELÄNDER- SYSTEME

Easy Alu	268 - 281
Square Line® 40x10	282 - 283
Square Line® 40x20	284 - 287
Square Line® 40x40	288 - 301
Square Line® 60x30	302 - 307
Q-line	308 - 359
Barrier Line	360 - 361
Q-line hochglanzpoliert	362 - 371
Schweißteile	372 - 381
Bendywood	384 - 385
Naturail	386 - 387
Füllungen	388 - 421





# EASY ALU

<b>Beanspruchung:</b>	Leicht und mittel
<b>Verwendung:</b>	Innen- und Außenbereich
<b>Montage:</b>	Boden- und Seitenmontage
<b>Anwendung:</b>	Balkone, Galerien, Wege, Abtrennungen, Treppen und französische Balkone
<b>Material:</b>	Aluminium (roh, gebürstet anodisiert oder pulver- beschichtet)
<b>Glasstärke:</b>	8 bis 10,76 mm

Finden Sie alle Informationen  
zu Easy Alu online:

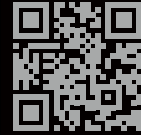

[https://q-ne.ws/  
EasyAlu23](https://q-ne.ws/EasyAlu23)





## Schnelle Montage, maximaler Komfort

Easy Alu bietet Ihnen alle Vorteile eines hochwertigen Aluminiumgeländers und vereint dabei die gewohnt hohe Q-railing Qualität mit einer beeindruckenden Optik. Profitieren Sie von einer hohen Kosteneffizienz, vielfältigen Anpassungsmöglichkeiten und der Tatsache, dass Sie die Komponenten in Ihrer Werkstatt zu kompletten Geländermodulen vormontieren können. Noch schneller und einfacher geht es, wenn Sie bereits baustellenfertige Module bestellen, die nach Ihren Spezifikationen maßgefertigt werden. Einfach am Boden verankern und fertig!

Easy Alu	DE Bodenmontage	DE Seitenmontage
Max. Holmlast (kN/m)	0,5	0,5
Max. Pfostenabstand (Meter)	1,5	1,37

STATISCHE  
BERECH-  
NUNG  
DIN 18008

AbP  
BALAST  
GEPRÜFT

Bitte beachten Sie die Spezifikationen wie Befestigungs- und Glasmaße sowie Glastypen der jeweiligen Zertifikate. Für weitere Informationen besuchen Sie [www.q-railing.com/zertifikate](http://www.q-railing.com/zertifikate)

International getestet/berechnet/zertifiziert:



- 1 Beinhaltet das Glass Wing Gummi:  
Setzen Sie das Glas schnell und ohne hohen Krafteinsatz in die Profile ein. Das Gummi legt sich fest um das Glas.
- 2 Wählen Sie aus drei Bestelloptionen.
- 3 Nivellierblock zur Justierung des Geländers.

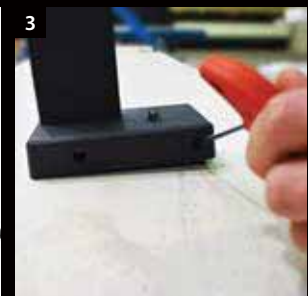

## EASY ALU FÜLLUNGEN

### Glas

- Glas
  - Glas mit Mittelstrebe
- Auf Anfrage erhältlich:
- Stabausfachung
  - Blechfüllung



388 - 389

## 3 BESTELL- OPTIONEN

281





**Geländerpfosten, Bodenmontage**

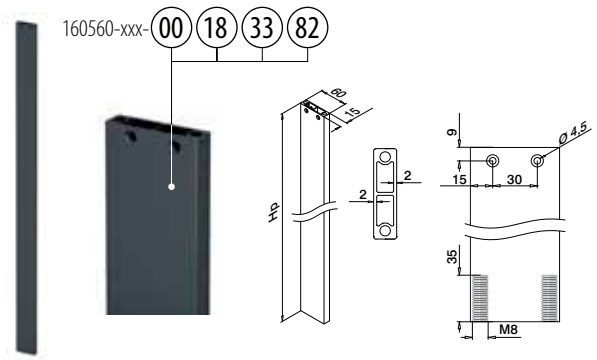
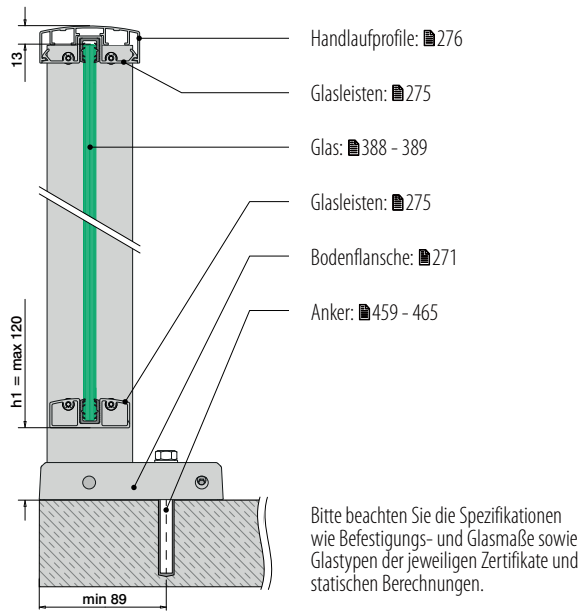

**MOD 0560**

Aluminium Roh	Hp		
160560-087-00	865	QS-30	474 1
160560-097-00	965	QS-30	474 1
160560-107-00	1065	QS-30	474 1
160560-117-00	1165	QS-30	474 1

Aluminium Gebürstet	OUTDOOR		
160560-087-18	865	QS-30	474 1
160560-097-18	965	QS-30	474 1
160560-107-18	1065	QS-30	474 1
160560-117-18	1165	QS-30	474 1

Aluminium Pulverbeschichtet RAL 7016, strukturiert	OUTDOOR		
160560-087-33	865	QS-30	474 1
160560-097-33	965	QS-30	474 1
160560-107-33	1065	QS-30	474 1
160560-117-33	1165	QS-30	474 1

Aluminium Black Line	OUTDOOR		
NEW 160560-087-82	865	QS-30	474 1
NEW 160560-097-82	965	QS-30	474 1
NEW 160560-107-82	1065	QS-30	474 1
NEW 160560-117-82	1165	QS-30	474 1



**Berechnungen – Geländerpfosten, Bodenmontage**

Geländerhöhe (H) – 35 mm = Höhe Geländerpfosten (Hp)

Geländerhöhe (H)	Höhe Geländerpfosten (Hp)
900 mm	865 mm
1000 mm	965 mm
1100 mm	1065 mm
1200 mm	1165 mm

**Q-INFO**

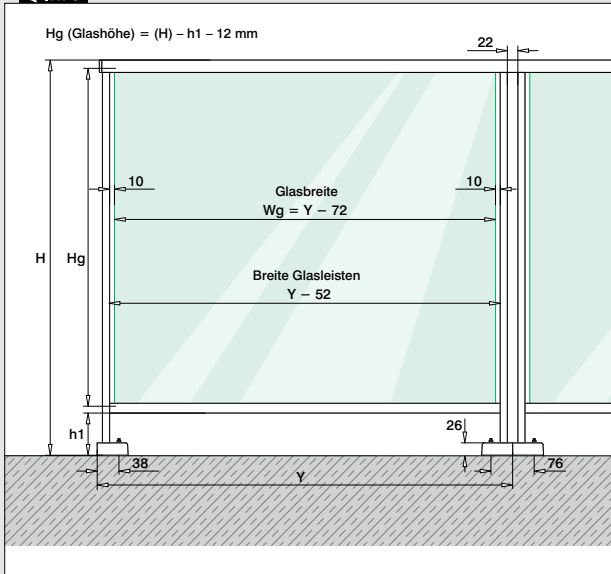

**Q-INFO Aluminium**

<b>00</b> Roh	<b>18</b> Gebürstet, anodisiert	<b>33 RAL 7016</b> Pulverbeschichtet Anthrazitgrau, matt, strukturiert	<b>82 RAL 9005</b> Pulverbeschichtet Schwarz, matt, strukturiert
------------------	------------------------------------	--	--

**Q-INFO**

Bodenflansche, Bodenmontage

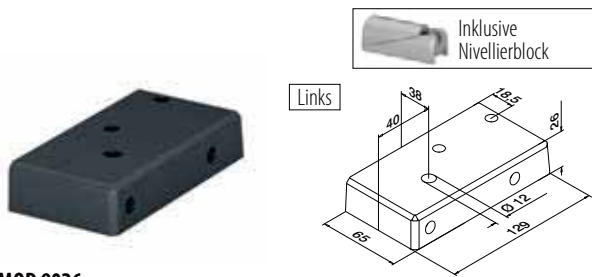

MOD 9026

<b>Aluminium</b> Roh		
169026-012-01-00	459 - 465	1
<b>Aluminium</b> Gebürstet		
<b>OUTDOOR</b>		
169026-012-01-18	459 - 465	1
<b>Aluminium</b> Pulverbeschichtet RAL 7016, strukturiert		
<b>OUTDOOR</b>		
169026-012-01-33	459 - 465	1
<b>Aluminium</b> Black Line		
<b>OUTDOOR</b>		
<b>NEW</b> 169026-012-01-82	459 - 465	1

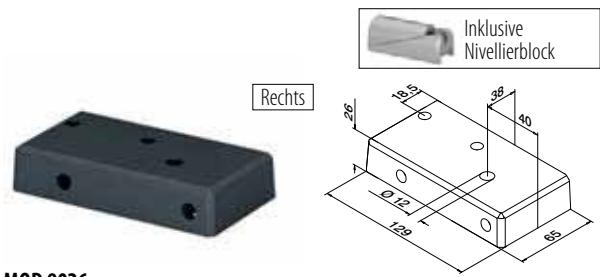

MOD 9026

<b>Aluminium</b> Roh		
169026-012-02-00	459 - 465	1
<b>Aluminium</b> Gebürstet		
<b>OUTDOOR</b>		
169026-012-02-18	459 - 465	1
<b>Aluminium</b> Pulverbeschichtet RAL 7016, strukturiert		
<b>OUTDOOR</b>		
169026-012-02-33	459 - 465	1
<b>Aluminium</b> Black Line		
<b>OUTDOOR</b>		
<b>NEW</b> 169026-012-02-82	459 - 465	1

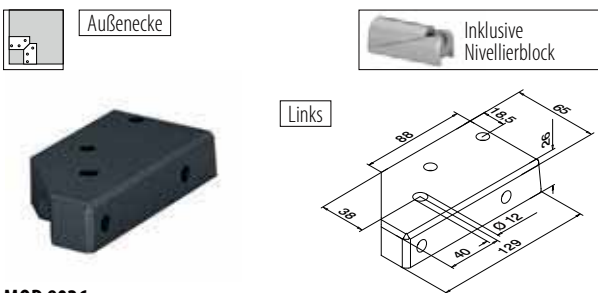

MOD 9026

<b>Aluminium</b> Roh		
169026-012-91-00	459 - 465	1
<b>Aluminium</b> Gebürstet		
<b>OUTDOOR</b>		
169026-012-91-18	459 - 465	1
<b>Aluminium</b> Pulverbeschichtet RAL 7016, strukturiert		
<b>OUTDOOR</b>		
169026-012-91-33	459 - 465	1
<b>Aluminium</b> Black Line		
<b>OUTDOOR</b>		
<b>NEW</b> 169026-012-91-82	459 - 465	1

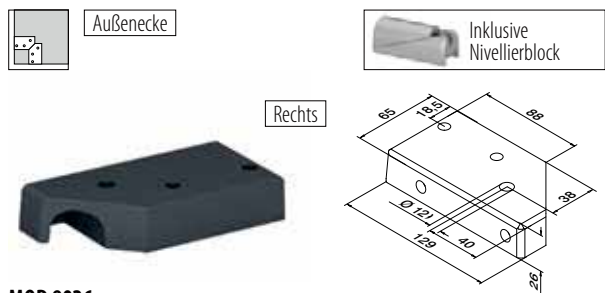

MOD 9026

<b>Aluminium</b> Roh		
169026-012-92-00	459 - 465	1
<b>Aluminium</b> Gebürstet		
<b>OUTDOOR</b>		
169026-012-92-18	459 - 465	1
<b>Aluminium</b> Pulverbeschichtet RAL 7016, strukturiert		
<b>OUTDOOR</b>		
169026-012-92-33	459 - 465	1
<b>Aluminium</b> Black Line		
<b>OUTDOOR</b>		
<b>NEW</b> 169026-012-92-82	459 - 465	1

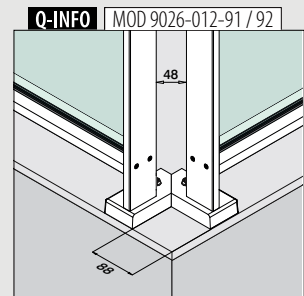
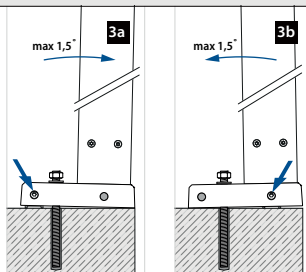
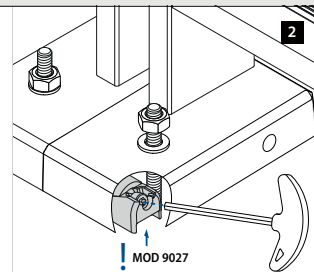
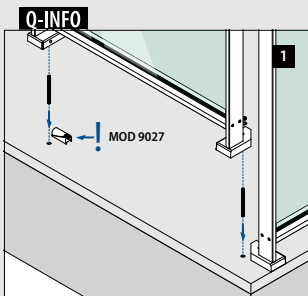



EASY ALU



Geländerpfosten, Seitenmontage

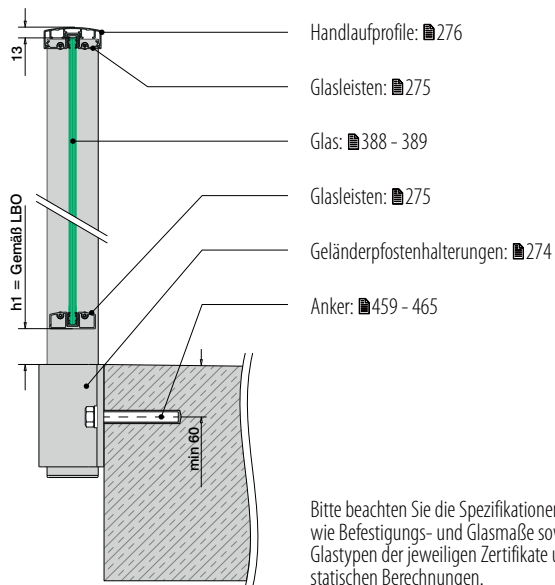

Berechnungen - Geländerpfosten, Seitenmontage

Geländerhöhe (H) + 140 mm = Höhe Geländerpfosten (Hp)

Geländerhöhe (H)	Höhe Geländerpfosten (Hp)
900 mm	1040 mm
1000 mm	1140 mm
1100 mm	1240 mm
1200 mm	1340 mm

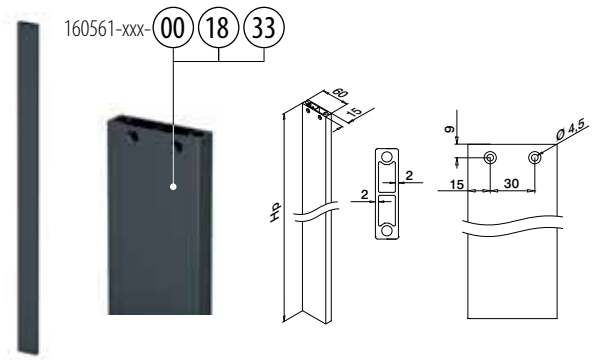

MOD 0561

Aluminium Roh	Hp	☐
160561-104-00	1040	1
160561-114-00	1140	1
160561-124-00	1240	1
160561-134-00	1340	1
Aluminium Gebürstet		
<b>OUTDOOR</b>		
160561-104-18	1040	1
160561-114-18	1140	1
160561-124-18	1240	1
160561-134-18	1340	1
Aluminium Pulverbeschichtet RAL 7016		
<b>OUTDOOR</b>		
160561-104-33	1040	1
160561-114-33	1140	1
160561-124-33	1240	1
160561-134-33	1340	1



Q-INFO

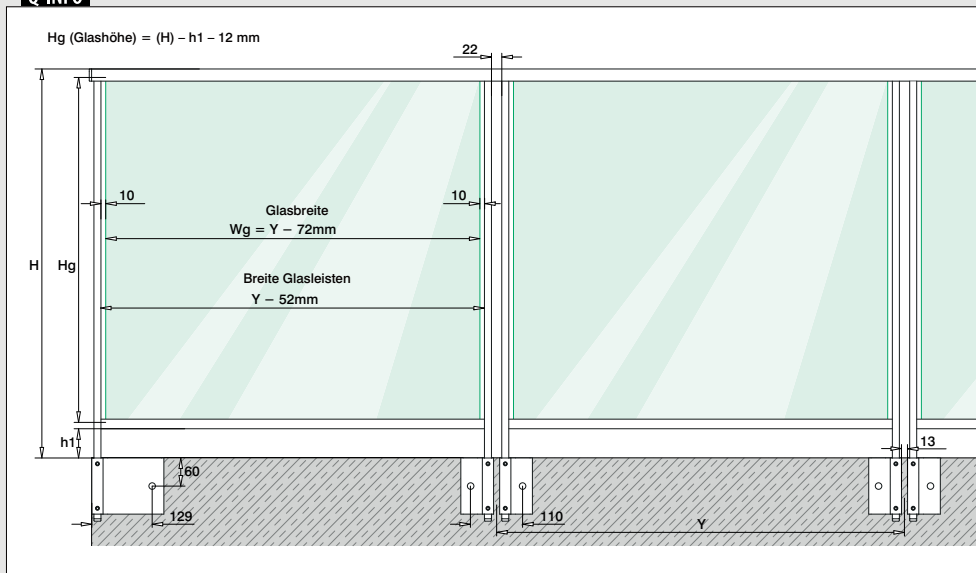

Q-INFO

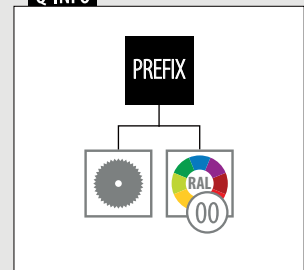

Geländerpfostenhalterungen, Seitenmontage

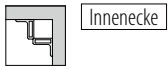

Innenecke



Links / rechts

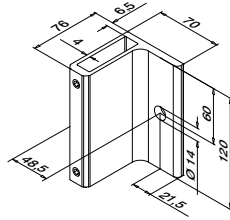

**MOD 9028**

<b>Aluminium</b> Roh		
169028-120-00-00	459 - 465	1
<b>Aluminium</b> Matt Silbereffekt		
<b>OUTDOOR</b>		
169028-120-00-08	459 - 465	1
<b>Aluminium</b> Pulverbeschichtet RAL 7016, strukturiert		
<b>OUTDOOR</b>		
169028-120-00-33	459 - 465	1

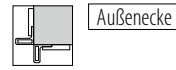

Außenecke



Links / rechts

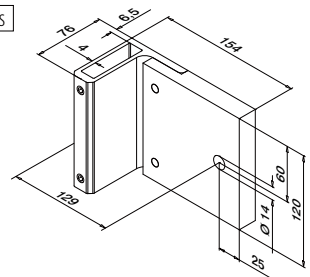

**MOD 9028**

<b>Aluminium</b> Roh		
169028-120-90-00	459 - 465	1
<b>Aluminium</b> Matt Silbereffekt		
<b>OUTDOOR</b>		
169028-120-90-08	459 - 465	1
<b>Aluminium</b> Pulverbeschichtet RAL 7016, strukturiert		
<b>OUTDOOR</b>		
169028-120-90-33	459 - 465	1



Endkappen für Pfosten, Seitenmontage



Unten

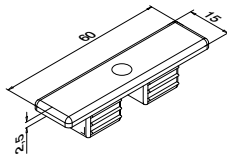

**MOD 5743 - EASY HIT®**

<b>Kunststoff</b> Aluminium RAL 9006	
<b>OUTDOOR</b>	
155743-36	2
<b>Kunststoff</b> Anthrazitgrau RAL 7016	
<b>OUTDOOR</b>	
155743-33	2



**Q-INFO** MOD 9028

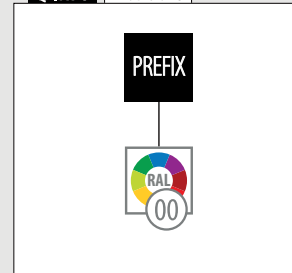

**Q-INFO** Kunststoff



**Q-INFO** MOD 5743 / 9028

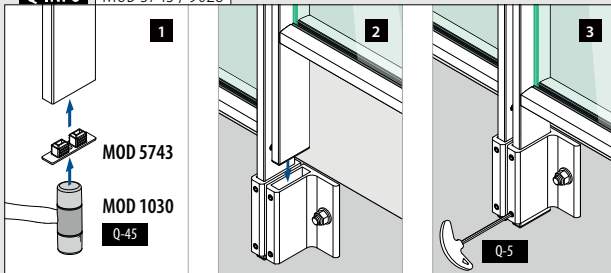

**Q-INFO** Aluminium



**Q-INFO** MOD 9028-120-00 / 9028-120-90

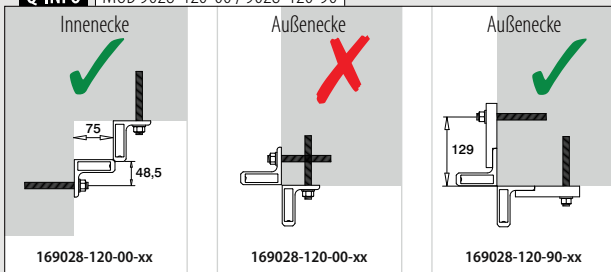

**Q-INFO** MOD 9028-120-90

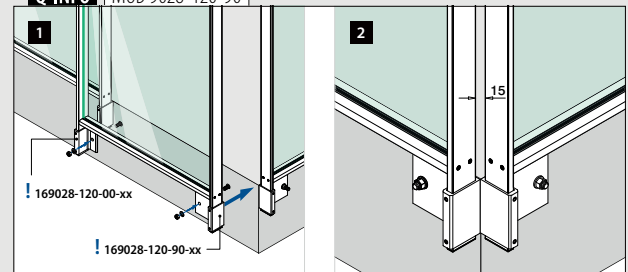



Glasleisten

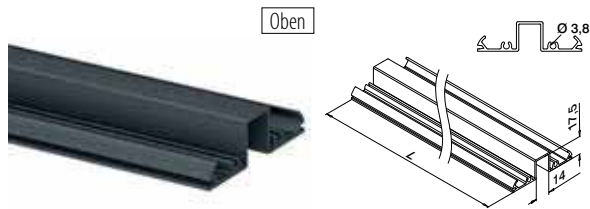

**MOD 5951**

<b>Aluminium</b>	Roh		
165951-050-00	QS-267	473	L = 5 m
<b>Aluminium</b>	Gebürstet		
<b>OUTDOOR</b>			
165951-050-18	QS-267	473	L = 5 m
<b>Aluminium</b>	Pulverbeschichtet RAL 7016, strukturiert		
<b>OUTDOOR</b>			
165951-050-33	QS-267	473	L = 5 m
<b>Aluminium</b>	<b>Black Line</b>		
<b>OUTDOOR</b>			
<b>NEW</b>	165951-050-82	QS-267	473 L = 5 m

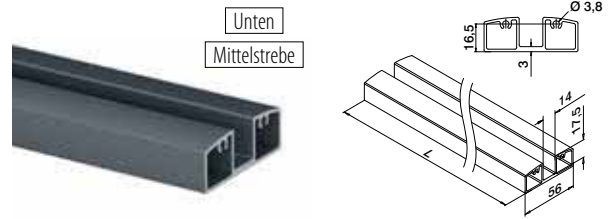

**MOD 5952**

<b>Aluminium</b>	Roh		
165952-050-00	QS-267	473	L = 5 m
<b>Aluminium</b>	Gebürstet		
<b>OUTDOOR</b>			
165952-050-18	QS-267	473	L = 5 m
<b>Aluminium</b>	Pulverbeschichtet RAL 7016, strukturiert		
<b>OUTDOOR</b>			
165952-050-33	QS-267	473	L = 5 m
<b>Aluminium</b>	<b>Black Line</b>		
<b>OUTDOOR</b>			
<b>NEW</b>	165952-050-82	QS-267	473 L = 5 m



Glass Wing Gummiprofile

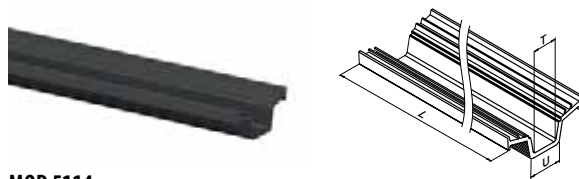

**MOD 5114**

<b>Zubehör</b>			
Für monolithisches Glas	<b>U</b>	<b>T</b>	
205114-050-08	14	8	L = 5 m
205114-050-10	14	10	L = 5 m
Für laminiertes Glas			
205114-050-08	14	8,76	L = 5 m
205114-050-10	14	9,52 - 10,76	L = 5 m

Internationaler Geschmacksmusterschutz

Adapter für Glasleisten

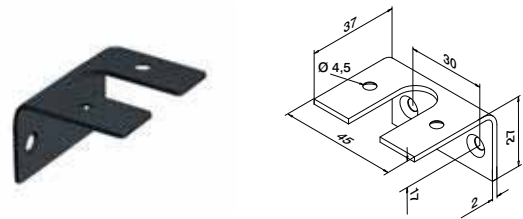

**MOD 5960**

<b>Aluminium</b>	Roh		
165960-00	QS-268	473	4
<b>Aluminium</b>	Gebürstet		
<b>OUTDOOR</b>			
165960-18	QS-268	473	4
<b>Aluminium</b>	Pulverbeschichtet RAL 7016, strukturiert		
<b>OUTDOOR</b>			
165960-33	QS-268	473	4
<b>Aluminium</b>	<b>Black Line</b>		
<b>OUTDOOR</b>			
<b>NEW</b>	165960-82	QS-268	473 4



**Q-INFO** | MOD 5952

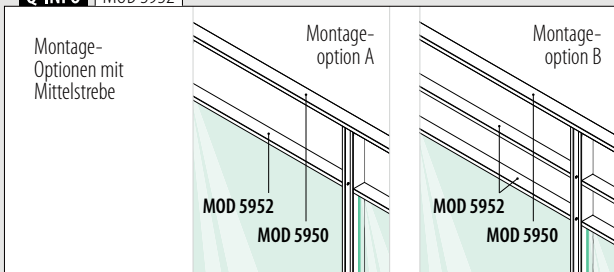

**Q-INFO** | MOD 5951 / 5952 / 5960

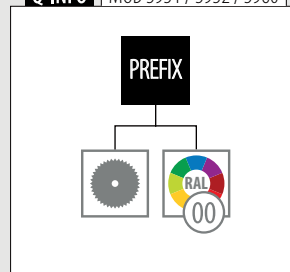

**Q-INFO** | MOD 5960



Handlaufprofile

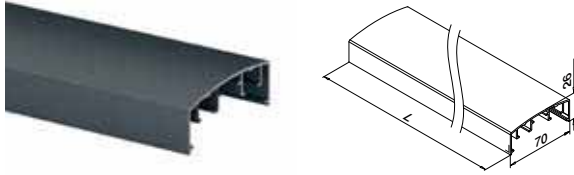

**MOD 5950**

<b>Aluminium</b>	Roh	
165950-050-00		L = 5 m
<b>Aluminium</b>	Gebürstet	
<b>OUTDOOR</b>		
165950-050-18		L = 5 m
<b>Aluminium</b>	Pulverbeschichtet RAL 7016, strukturiert	
<b>OUTDOOR</b>		
165950-050-33		L = 5 m
<b>Aluminium</b>	<b>Black Line</b>	
<b>OUTDOOR</b>		
<b>NEW</b>	165950-050-82	L = 5 m

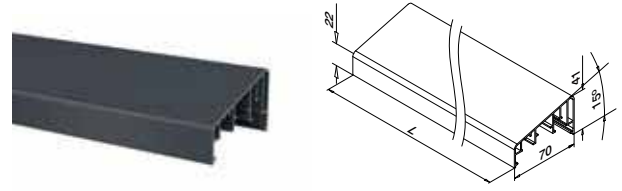

**MOD 5953**

<b>Aluminium</b>	Roh	
165953-050-00		L = 5 m
<b>Aluminium</b>	Gebürstet	
<b>OUTDOOR</b>		
165953-050-18		L = 5 m
<b>Aluminium</b>	Pulverbeschichtet RAL 7016, strukturiert	
<b>OUTDOOR</b>		
165953-050-33		L = 5 m
<b>Aluminium</b>	<b>Black Line</b>	
<b>OUTDOOR</b>		
165953-050-82		L = 5 m



**Q-INFO Aluminium**

<b>00</b>  Roh	<b>18</b>  Gebürstet, anodisiert	<b>33 RAL 7016</b>  Pulver- beschichtet Anthrazitgrau, matt, strukturiert	<b>82 RAL 9005</b>  Pulver- beschichtet Schwarz, matt, strukturiert
----------------------	---	--	--

**Q-INFO**

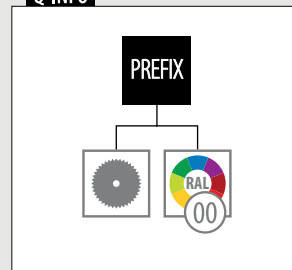

**Q-INFO**

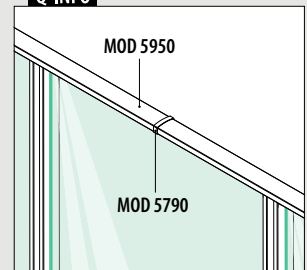

Abdeckkappen für Verbinder

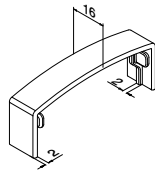

**MOD 5790**

<b>Kunststoff</b>	Weißaluminium RAL 9006
<b>OUTDOOR</b>	
155790-36	2
<b>Kunststoff</b>	Anthrazitgrau RAL 7016
<b>OUTDOOR</b>	
155790-33	2
<b>Kunststoff</b>	Schwarz RAL 9005
<b>OUTDOOR</b>	
<b>NEW</b> 155790-80	2

90° Ecke

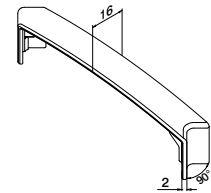

**MOD 5314**

<b>Kunststoff</b>	Weißaluminium RAL 9006
<b>OUTDOOR</b>	
155314-36	2
<b>Kunststoff</b>	Anthrazitgrau RAL 7016
<b>OUTDOOR</b>	
155314-33	2
<b>Kunststoff</b>	Schwarz RAL 9005
<b>OUTDOOR</b>	
<b>NEW</b> 155314-80	2

Verbinder

Justierbar

2x pro Ecke / Verbindung

0 - 90°

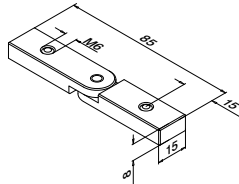

**MOD 5313**

<b>Aluminium</b>	Roh
165313	2



**Q-INFO** Kunststoff



36 RAL 9006

Weißaluminium, satiniert, glatt

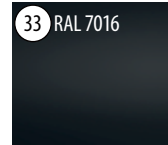

33 RAL 7016

Anthrazitgrau, matt, glatt



80 RAL 9005

Schwarz, satiniert, strukturiert

**Q-INFO** MOD 5313 / 5314

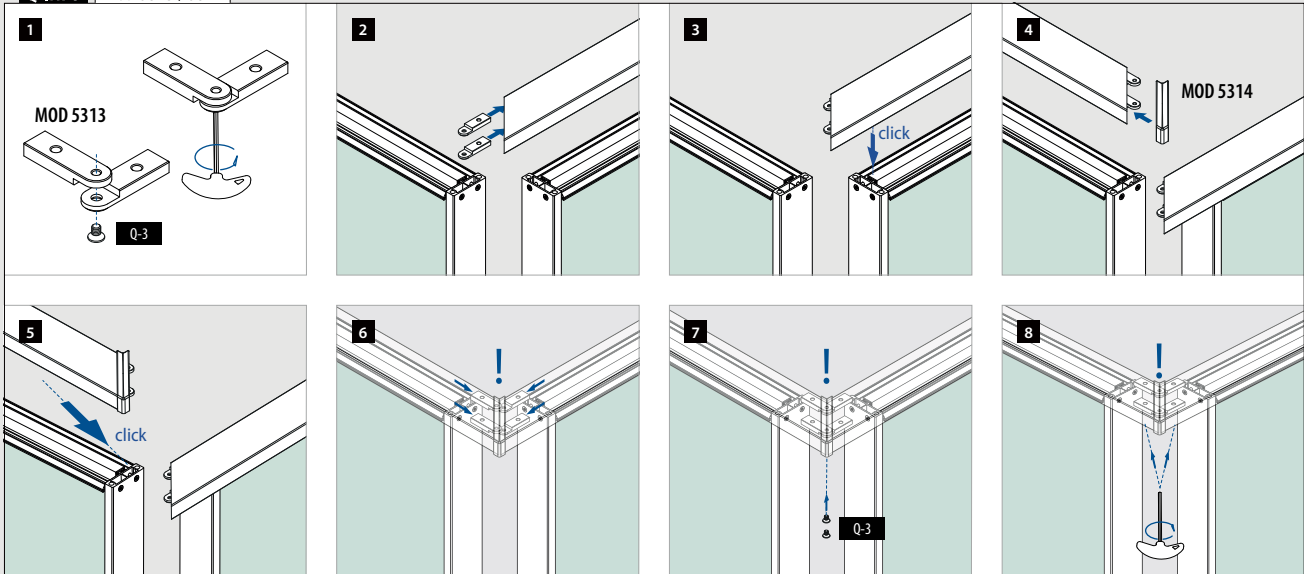

**Q-INFO** MOD 5313 / 5790

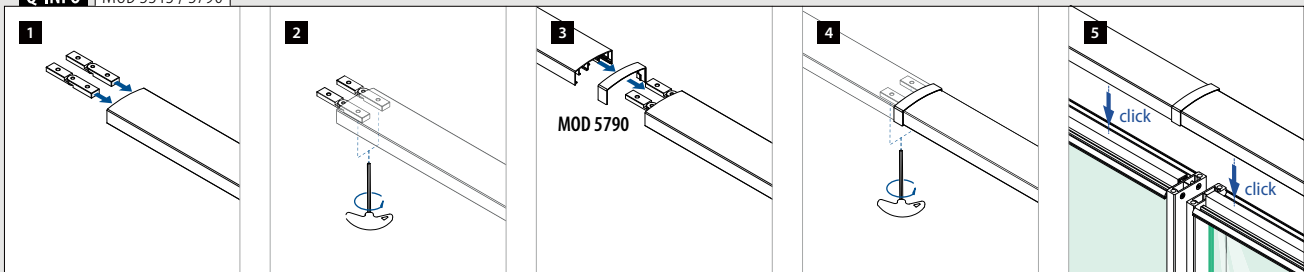

## Endkappen für Handlaufprofile

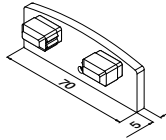

## MOD 5742 - EASY HIT®

Aluminium Roh

165742-00



2

Aluminium Gebürstet

OUTDOOR

165742-18

2

Aluminium Pulverbeschichtet RAL 7016, strukturiert

OUTDOOR

165742-33

2

Aluminium Black Line

OUTDOOR

NEW 165742-82

2

PREFIX



## Wandflansche

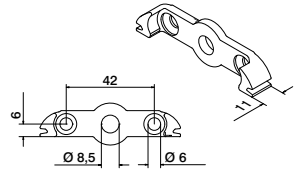

## MOD 5505

Aluminium Roh

165505

QS-267 473 / QS-87 472



2



## Q-INFO MOD 5742

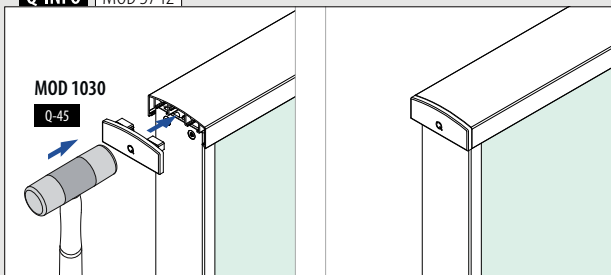

## Q-INFO MOD 5505

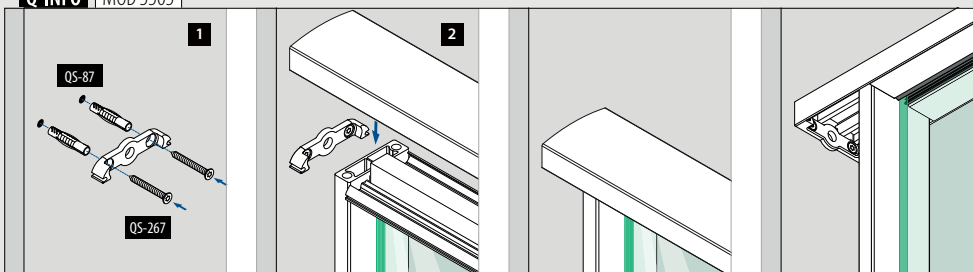

## Q-INFO MOD 5742

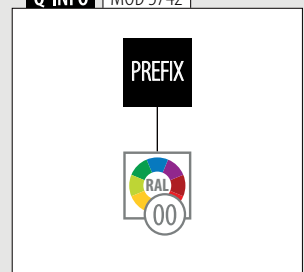

Endkappen für Handlaufprofile

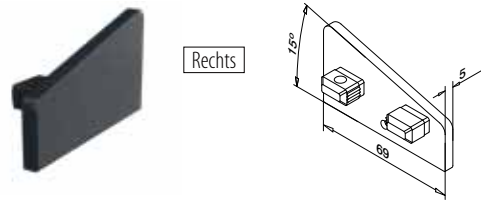
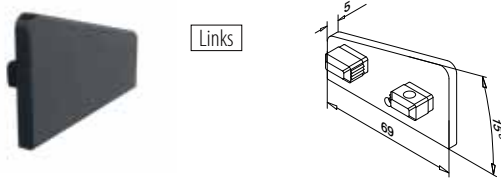

**MOD 5744**

<b>Aluminium</b> Roh	
165744-01-00	2
<b>Aluminium</b> Gebürstet	
<b>OUTDOOR</b>	
165744-01-18	2
<b>Aluminium</b> Pulverbeschichtet RAL 7016, strukturiert	
<b>OUTDOOR</b>	
165744-01-33	2
<b>Aluminium</b> <b>Black Line</b>	
<b>OUTDOOR</b>	
165744-01-82	2

NEW

**MOD 5744**

<b>Aluminium</b> Roh	
165744-02-00	2
<b>Aluminium</b> Gebürstet	
<b>OUTDOOR</b>	
165744-02-18	2
<b>Aluminium</b> Pulverbeschichtet RAL 7016, strukturiert	
<b>OUTDOOR</b>	
165744-02-33	2
<b>Aluminium</b> <b>Black Line</b>	
<b>OUTDOOR</b>	
165744-02-82	2

NEW

**Q-INFO Aluminium**

<b>00</b> 	<b>18</b> 	<b>33 RAL 7016</b>  Pulver- beschichtet	<b>82 RAL 9005</b>  Pulver- beschichtet
Roh	Gebürstet, anodisiert	Anthrazitgrau, matt, strukturiert	Schwarz, matt, strukturiert

**Q-INFO**

**PREFIX**





## Stabausfachung

Schaffen Sie mit der Stabausfachung für Easy Alu einen modernen französischen Balkon.  
Auf Anfrage erhältlich.

## Blechfüllung

Mit einer Blechfüllung verleihen Sie Pfostengeländern einen individuellen, ausdrucksstarken Look.  
Auf Anfrage erhältlich.

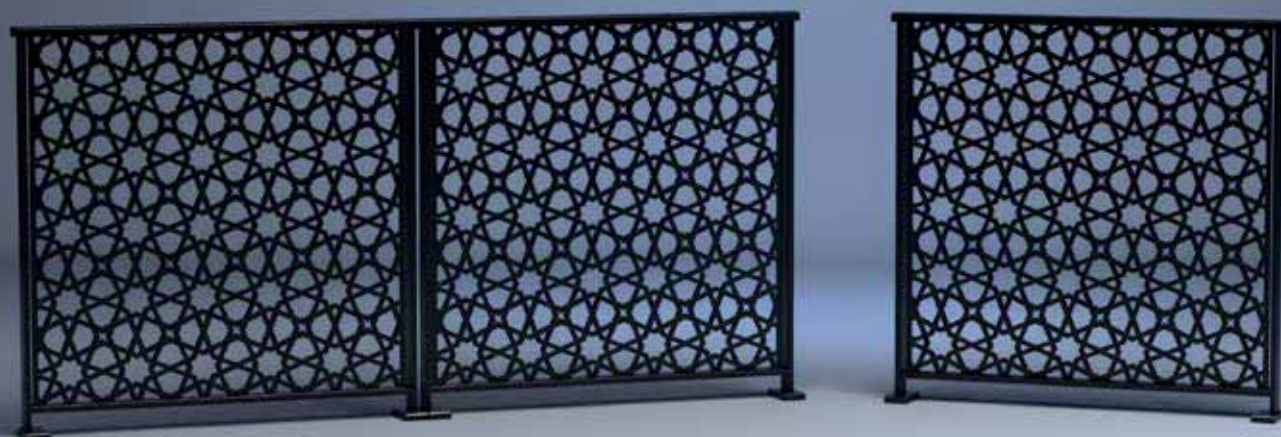

# IHRE BESTELLOPTIONEN

Option

## 1 MONTAGEFERTIGE MODULE

WIR:

- sägen und bohren nach Ihren Angaben
- liefern die gewünschte Oberflächenausführung (gebürstet, roh oder pulverbeschichtet in der gewünschten RAL-Farbe)
- montieren die Module für Sie vor
- liefern Ihnen die baustellenfertigen Segmente exakt nach Ihren Anforderungen

SIE:

- platzieren die Geländermodule auf der Baustelle
- verankern die Module am Boden
- befestigen den Handlauf



Option

## 2 VORGEFERTIGTE EINZELKOMPONENTEN

WIR:

- sägen und bohren nach Ihren Angaben
- lassen die Komponenten, falls gewünscht, pulverbeschichten
- liefern Ihnen die Komponenten exakt nach Ihren Anforderungen

SIE:

- fertigen aus den Komponenten die Geländermodule
- platzieren die Module auf der Baustelle
- verankern diese am Boden
- befestigen den Handlauf



Option

## 3 STANDARD-EINZELKOMPONENTEN

WIR:

- liefern Ihnen die gewünschten Einzelkomponenten in der Standardausführung

SIE:

- sägen, bohren und, falls gewünscht, pulverbeschichten die Komponenten
- fertigen aus den Komponenten die Geländermodule
- platzieren die Module auf der Baustelle
- verankern diese am Boden
- befestigen den Handlauf





Finden Sie alle Informationen zu Square Line® 40x10 online:



<https://q-ne.ws/SquareLine41-23>

# SQUARE LINE® 40x10

Handläufe

## Handlaufstützen

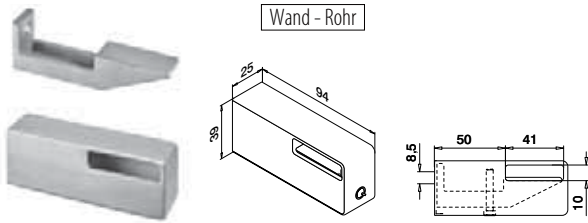

### MOD 4134

V2A	304	Gebürstet			
	<b>INDOOR</b>	<b>Für Rohr</b>			
	134134-041-12	40 x 10 x 1,5	QS-35	469 / QS-3	473 2
V2A	304	Black Line			
	<b>INDOOR</b>				
NEW	134134-041-82	40 x 10 x 1,5	QS-35	469 / QS-3	473 2
V4A	316	Gebürstet			
	<b>OUTDOOR</b>				
SELL OUT	144134-041-12	40 x 10 x 1,5	QS-34	469 / QS-4	473 2



Internationaler Geschmacksmusterschutz

Handläufe

## Rohre

## Q-TUBE

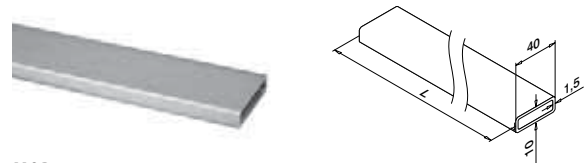

### MOD 4900

V2A	304	Gebürstet			
	<b>INDOOR</b>				
	134900-041-25-12	40 x 10 x 1,5			L = 2,5 m
	134900-041-50-12	40 x 10 x 1,5			L = 5 m
V2A	304	Black Line			
	<b>INDOOR</b>				
NEW	134900-041-50-82	40 x 10 x 1,5			L = 5 m
V4A	316	Gebürstet			
	<b>OUTDOOR</b>				
SELL OUT	144900-041-25-12	40 x 10 x 1,5			L = 2,5 m
SELL OUT	144900-041-50-12	40 x 10 x 1,5			L = 5 m



### Q-INFO | MOD 4134 / 4900

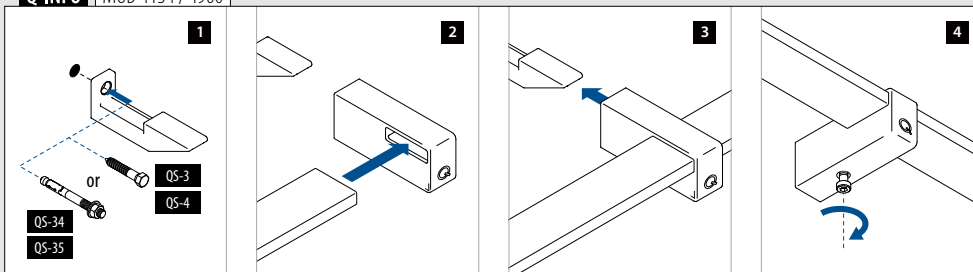

### Q-INFO | MOD 4900

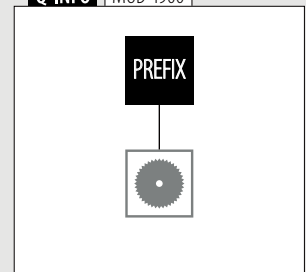







Finden Sie alle  
Informationen zu  
Square Line® 40x20 online:

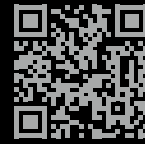

[https://q-ne.ws/  
SquareLine42-23](https://q-ne.ws/SquareLine42-23)

# SQUARE LINE® 40x20

SCHLICHTE UND  
ELEGANTE HANDLÄUFE



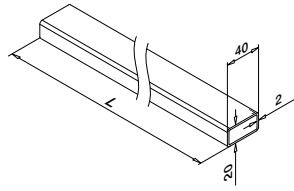

## MOD 4900

V2A	304	Gebürstet		
<b>INDOOR</b>			<input type="checkbox"/>	
134900-020-50-12	40 x 20 x 2,0			L = 5 m

V4A	316	Gebürstet		
<b>OUTDOOR</b>				
NEW	144900-020-50-12	40 x 20 x 2,0		L = 5 m

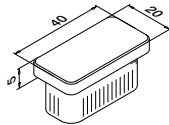

## MOD 5728 - EASY HIT®

V2A	304	Gebürstet		
<b>INDOOR</b>		<b>Für Rohr</b>	<input type="checkbox"/>	
135728-020-12	40 x 20 x 2,0			2

V4A	316	Gebürstet		
<b>OUTDOOR</b>				
NEW	145728-020-12	40 x 20 x 2,0		2

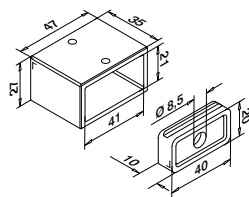

## MOD 4504

V2A	304	Gebürstet		
<b>INDOOR</b>		<b>Für Rohr</b>	<input type="checkbox"/>	
134504-020-12	40 x 20 x 2,0	QS-55  472 / QS-26  474		2

V4A	316	Gebürstet		
<b>OUTDOOR</b>				
144504-020-12	40 x 20 x 2,0	QS-55  472 / QS-27  474		2

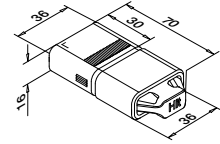

## MOD 5794 - EASY HIT®

V4A	316	Roh		
<b>OUTDOOR</b>		<b>Für Rohr</b>	<input type="checkbox"/>	
145794-020	40 x 20 x 2,0			2

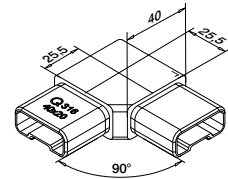

## MOD 4301

V2A	304	Gebürstet		
<b>INDOOR</b>		<b>Für Rohr</b>	<input type="checkbox"/>	
134301-020-12	40 x 20 x 2,0			2

V4A	316	Gebürstet		
<b>OUTDOOR</b>				
144301-020-12	40 x 20 x 2,0			2



0-70°

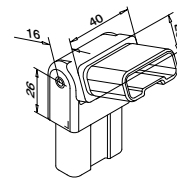

## MOD 4312

V2A	304	Gebürstet		
<b>INDOOR</b>		<b>Für Rohr</b>	<input type="checkbox"/>	
134312-020-12	40 x 20 x 2,0			2

V4A	316	Gebürstet		
<b>OUTDOOR</b>				
144312-020-12	40 x 20 x 2,0			2



Q-INFO MOD 4900

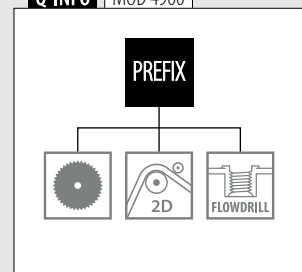



Für flaches Rohr

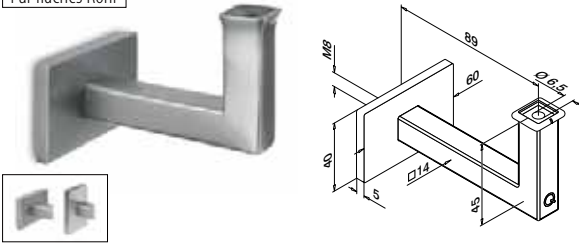

**MOD 4111**

V2A	304	Gebürstet		
<b>INDOOR</b>				
134111-000-12		QS-1	473 / QS-54	474
2				
V4A	316	Gebürstet		
<b>OUTDOOR</b>				
NEW	144111-000-12	QS-2	473 / QS-70	474
2				



Für flaches Rohr

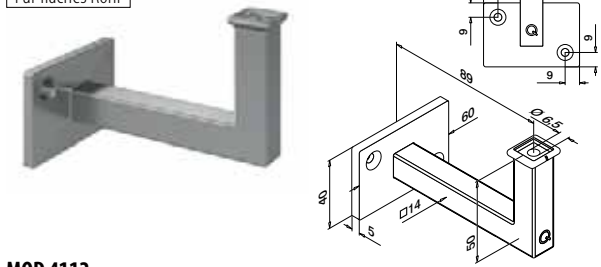

**MOD 4112**

V2A	304	Gebürstet		
<b>INDOOR</b>				
134112-000-12		QS-5	473 / QS-54	474
2				
V4A	316	Gebürstet		
<b>OUTDOOR</b>				
NEW	144112-000-12	QS-6	473 / QS-70	474
2				



**Q-INFO** MOD 4111

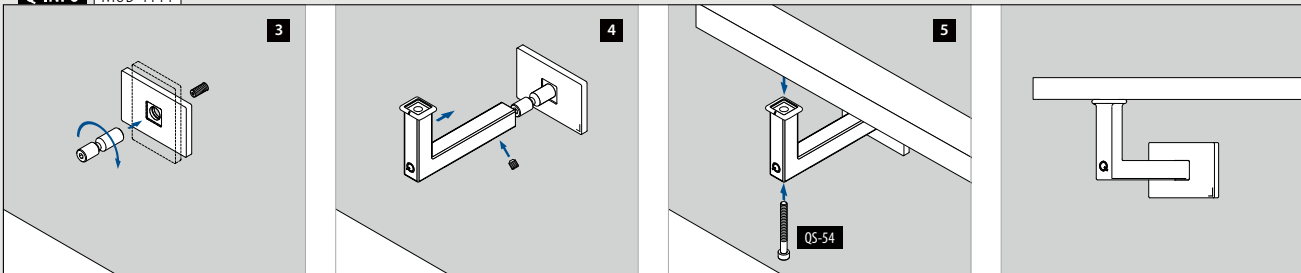

**Q-INFO** MOD 4111 / 4112

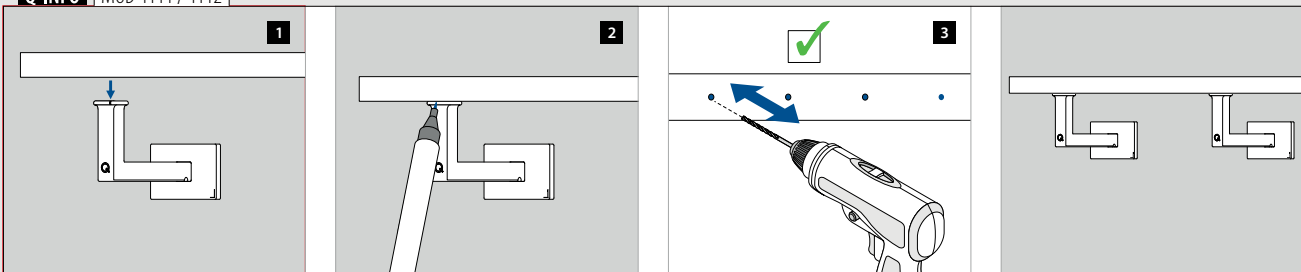



- Beanspruchung:** Leicht und mittel  
**Verwendung:** Innen- und Außenbereich  
**Montage:** Boden-, In-Boden- und Seitenmontage  
**Anwendung:** Balkone, Galerien, Wege, Abtrennungen, Treppen und Französische Balkone  
**Material:** Edelstahl V2A oder V4A (gebürstet oder pulverbeschichtet RAL 9005 schwarz)

Finden Sie alle Informationen zu Square Line® 40x40 online:



<https://q-ne.ws/SquareLine44-23>

# SQUARE LINE® 40x40





## Für einen geradlinigen, modernen Look

Square Line® 40x40 stellt eindrucksvoll unter Beweis, dass gutes Design nicht kompliziert sein muss. Mit seinen klaren Linien und Elementen aus Edelstahl schaffen Sie elegante, moderne Geländer und Treppengeländer. Möchten Sie runde Formen integrieren? Kein Problem! Square Line ist ein vollmodulares System, das Sie beliebig mit Komponenten aus anderen Q-railing Pfostengeländersystemen kombinieren können.

### Square Line® 40x40

Max. Holmlast (kN/m)

DE

0,5

STATISCHE  
BERECH-  
NUNG  
DIN 18008

Bitte beachten Sie die Spezifikationen wie Befestigungs- und Glasmaße sowie Glastypen der jeweiligen Zertifikate.

- 1 Dieses System bietet eine große Auswahl an Füllungen, darunter Glas, Stäbe, Netze und Drahtseile.
- 2 Die Handläufe können mit einer LED-Beleuchtung versehen werden.
- 3 Schaffen Sie dank des Industriedesigns einen modernen Look.



## SQUARE LINE® 40x40 FÜLLUNGEN

### Glas

- Glasrahmenrohr
- Glasklemmen
- Glasadapter
- Glashalter



388 - 392

### Stab und Rohr

- Horizontale Geländerfüllung
- Vertikale Geländerfüllung

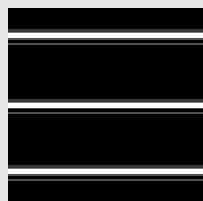

393 - 405

### Drahtseil

- Fast Fix Ø 3,2 mm
- Fast Fix Ø 4,0 mm
- Easy Fix Ø 3,2 mm
- Easy Fix Ø 6,0 mm

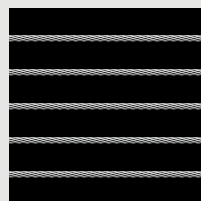

406 - 413

### Netz

- Easy Q-web

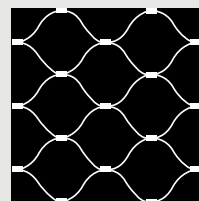

414 - 417

### Blech

- Blechadapter

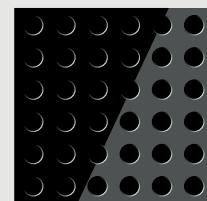

418 - 421



Geländerpfosten

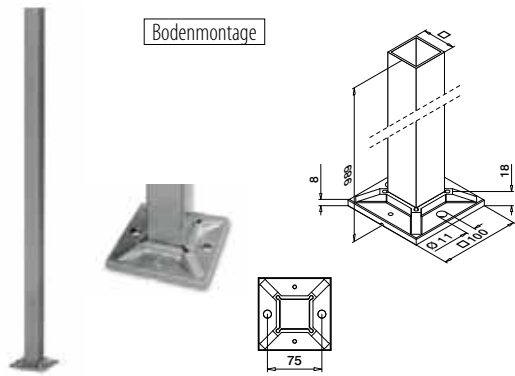

MOD 4921

V2A	304	Gebürstet		
<b>INDOOR</b>				
134921-040-12	40 x 40 x 2,0	Q5-59	469	1

V4A	316	Gebürstet		
<b>OUTDOOR</b>				
144921-040-12	40 x 40 x 2,0	Q5-58	469	1



Geländerpfostenrohre

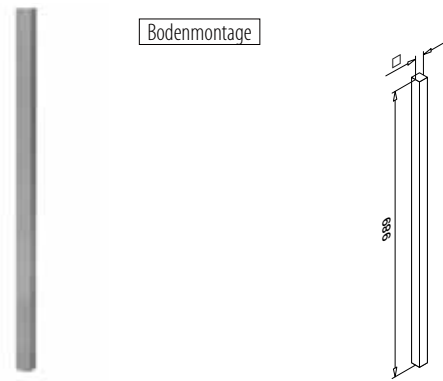

MOD 4901

V2A	304	Gebürstet		
<b>INDOOR</b>				
134901-040-12	40 x 40 x 2,0			1

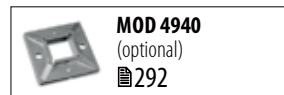

Abdeckkappen

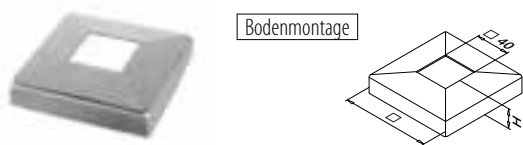

MOD 4511

V2A	304	Gebürstet		
<b>INDOOR</b>			<b>H</b>	
134511-040-12	108		25	2

V4A	316	Gebürstet		
<b>OUTDOOR</b>				
144511-040-12	108		25	2

Bodenflansche

Für Treppen

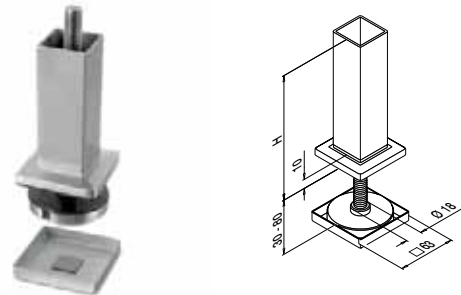

MOD 4546

V2A	304	Gebürstet		
<b>INDOOR</b>		<b>Für Rohr</b>	<input type="checkbox"/>	<b>H</b>
134546-040	40 x 40 x 2,0			100



Q-INFO | MOD 4921 / 4901 / 4546

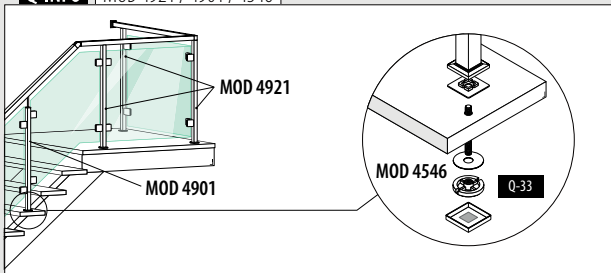

Q-INFO | MOD 4921 / 4901

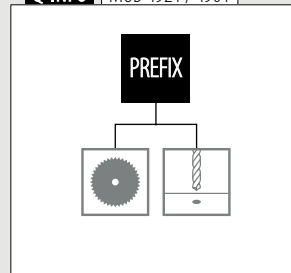

Q-INFO | MOD 4546 / 4901

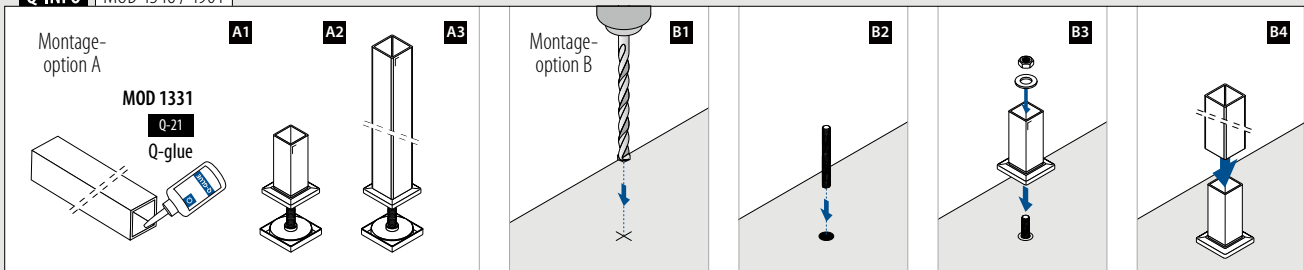

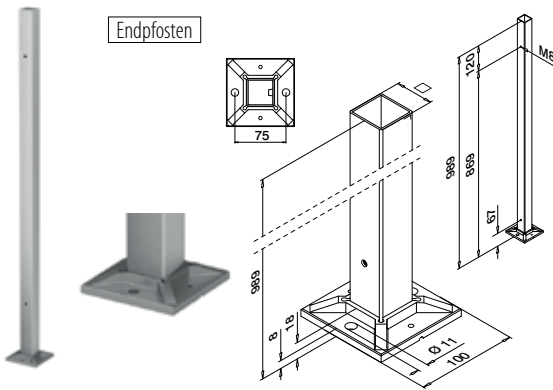

MOD 4972

V2A	304	Gebürstet			
<b>INDOOR</b>					
134972-040-01-12	40 x 40 x 2,0	QS-59	469	1	

V2A	304	Black Line			
<b>INDOOR</b>					
NEW 134972-040-01-82	40 x 40 x 2,0	QS-59	469	1	

V4A	316	Gebürstet			
<b>OUTDOOR</b>					
144972-040-01-12	40 x 40 x 2,0	QS-58	469	1	

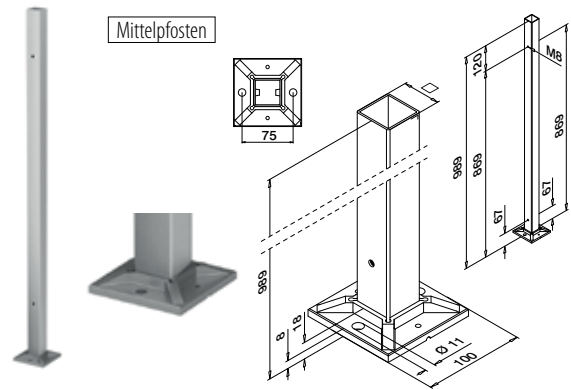

MOD 4972

V2A	304	Gebürstet			
<b>INDOOR</b>					
134972-040-02-12	40 x 40 x 2,0	QS-59	469	1	

V4A	316	Gebürstet			
<b>OUTDOOR</b>					
144972-040-02-12	40 x 40 x 2,0	QS-58	469	1	



Abdeckkappen

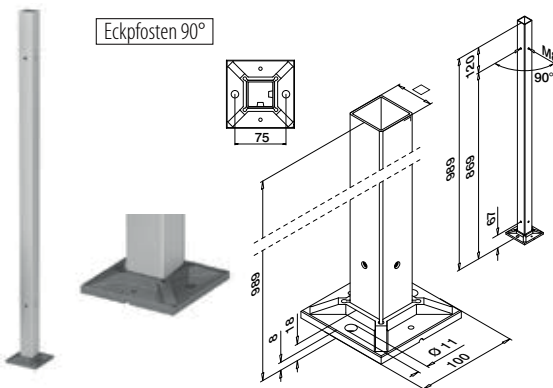

MOD 4972

V2A	304	Gebürstet			
<b>INDOOR</b>					
134972-040-90-12	40 x 40 x 2,0	QS-59	469	1	

V4A	316	Gebürstet			
<b>OUTDOOR</b>					
144972-040-90-12	40 x 40 x 2,0	QS-58	469	1	



MOD 4511

V2A	304	Gebürstet			
<b>INDOOR</b>					
134511-040-12	108	H	25	2	

V2A	304	Black Line			
<b>INDOOR</b>					
NEW 134511-040-82	108	25	2		

V4A	316	Gebürstet			
<b>OUTDOOR</b>					
144511-040-12	108	25	2		

POSTENGELENDERSYSTEME

SQUARE LINE® 40x40

Q-INFO

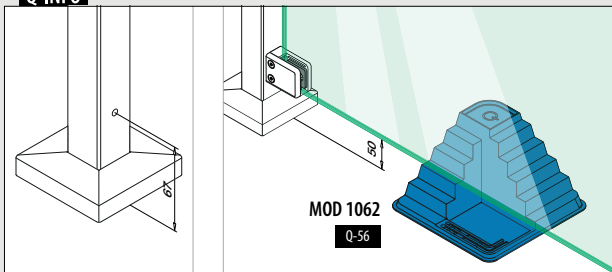

Q-INFO MOD 4972

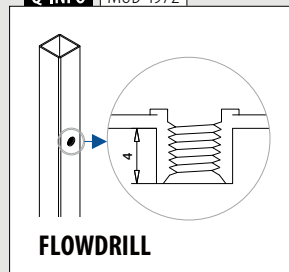

Q-INFO MOD 4972



Q-INFO 304



Geländerpfosten

Bodenflansche

Neigung einstellbar

Für Aufsteckrohre



+45°  
-45°

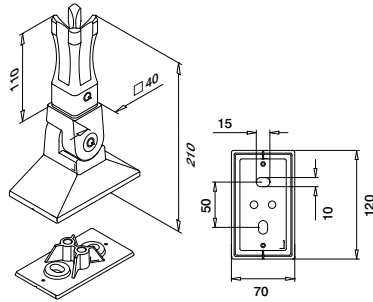

**MOD 4943**

V2A	<b>304</b>	Gebürstet			
	<b>INDOOR</b>	Für Rohr <input type="checkbox"/>			
SELL OUT	134943-040-12	40 x 40 x 2,0	QS-63	466	1
V4A	<b>316</b>	Gebürstet			
	<b>OUTDOOR</b>				
	144943-040-12	40 x 40 x 2,0	QS-62	466	1



Internationaler Geschmacksmusterschutz

Geländerpfosten

Bodenflansche

Für Aufsteckrohre

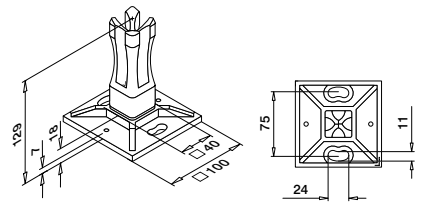

**MOD 4942**

V2A	<b>304</b>	Gebürstet			
	<b>INDOOR</b>	Für Rohr <input type="checkbox"/>			
SELL OUT	134942-040	40 x 40 x 2,0	QS-59	469	2
V4A	<b>316</b>	Gebürstet			
	<b>OUTDOOR</b>				
	144942-040	40 x 40 x 2,0	QS-58	469	2



Internationaler Geschmacksmusterschutz

Geländerpfosten

Abdeckkappen



Bodenmontage

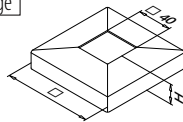

**MOD 4511**

V2A	<b>304</b>	Gebürstet			
	<b>INDOOR</b>	<input type="checkbox"/>	<b>H</b>		
	134511-040-12	108	25		2
V4A	<b>316</b>	Gebürstet			
	<b>OUTDOOR</b>				
	144511-040-12	108	25		2

Geländerpfosten

Bodenflansche für Geländerpfosten

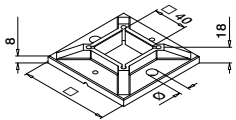
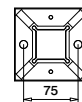

**MOD 4940**

V2A	<b>304</b>	Roh			
	<b>INDOOR</b>	<input type="checkbox"/>	$\emptyset$		
	134940-040	100	11	QS-59	469
V4A	<b>316</b>	Roh			
	<b>OUTDOOR</b>				
	144940-040	100	11	QS-58	469

Q-INFO MOD 4942 / 4901 / 4511

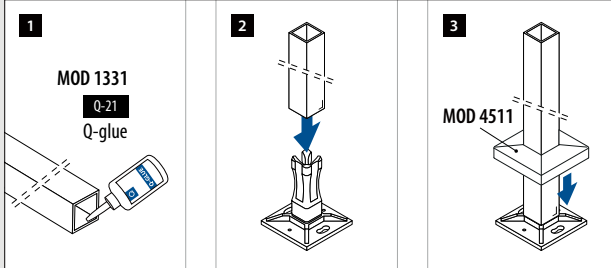

SELL OUT Nur solange der Vorrat reicht.

Q-INFO MOD 4943

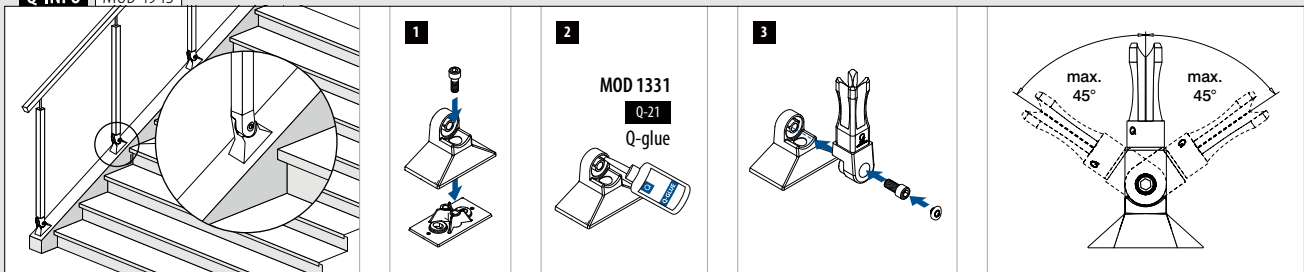

Geländerpfostenhalterungen

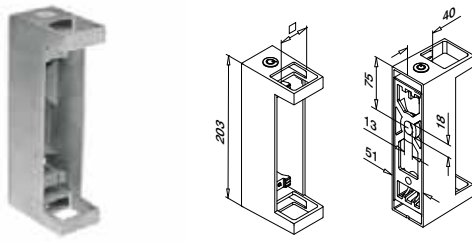

**MOD 4558**

<b>V2A</b>	<b>304</b>	Gebürstet			
	<b>INDOOR</b>	<input type="checkbox"/>			
	134558-040-12	40 x 40	QS-63	466	1
<b>V4A</b>	<b>316</b>	Gebürstet			
	<b>OUTDOOR</b>	<input type="checkbox"/>			
	144558-040-12	40 x 40	QS-62	466	1

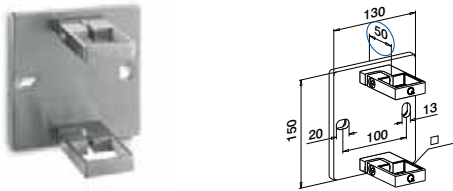

**MOD 4551**

<b>V2A</b>	<b>304</b>	Gebürstet			
	<b>INDOOR</b>	<input type="checkbox"/>			
	134551-040-12	40 x 40	QS-33	466	1



**MOD 0554**

<b>V2A</b>	<b>304</b>	Gebürstet			
	<b>INDOOR</b>	<input type="checkbox"/>	<b>Für Rohr</b>	<input type="checkbox"/>	
<b>SELL OUT</b>	130554-040-12	40 x 40			2
<b>V4A</b>	<b>316</b>	Gebürstet			
	<b>OUTDOOR</b>	<input type="checkbox"/>			
	140554-040-12	40 x 40			2

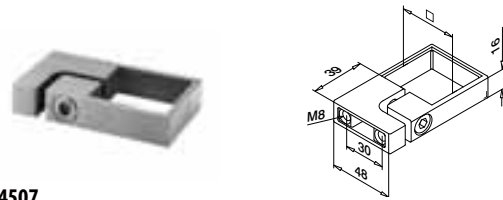

**MOD 4507**

<b>V2A</b>	<b>304</b>	Gebürstet			
	<b>INDOOR</b>	<input type="checkbox"/>			
	134507-040-12	40 x 40			2
<b>V4A</b>	<b>316</b>	Gebürstet			
	<b>OUTDOOR</b>	<input type="checkbox"/>			
<b>NEW</b>	144507-040-12	40 x 40			2

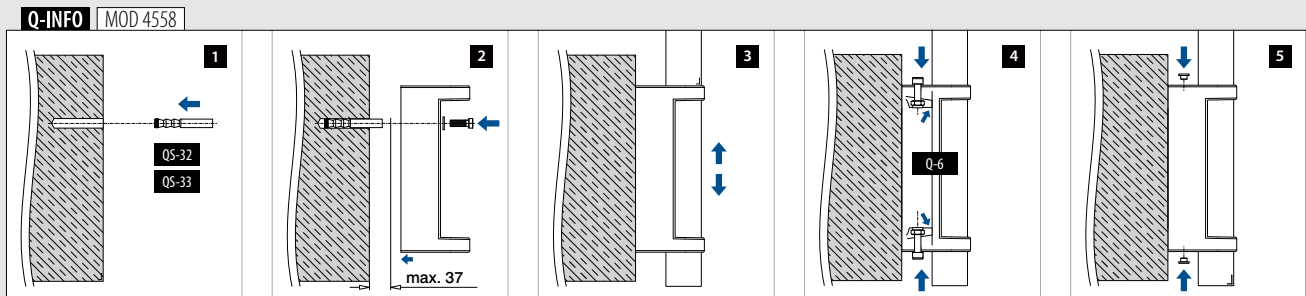
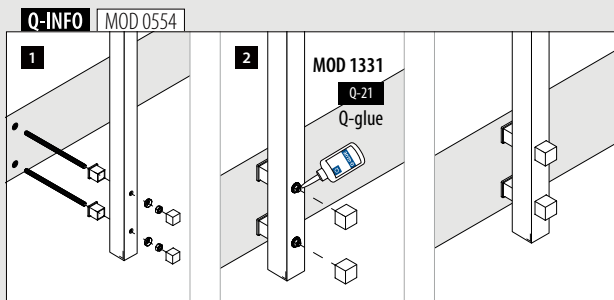

Für flaches Rohr

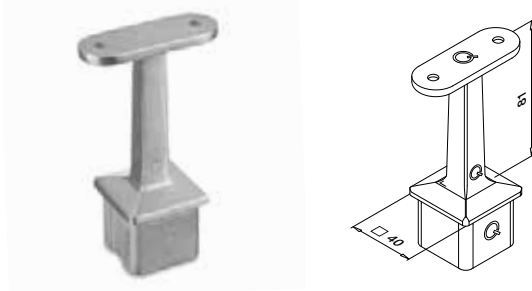

**MOD 4710**

V2A	304	Gebürstet	INDOOR	Für Rohr □	40 x 40 x 2,0	QS-12	474	2
V2A	304	Black Line	INDOOR					
<b>NEW</b>								
V4A	316	Gebürstet	OUTDOOR					



Für flaches Rohr zu rundem Rohr

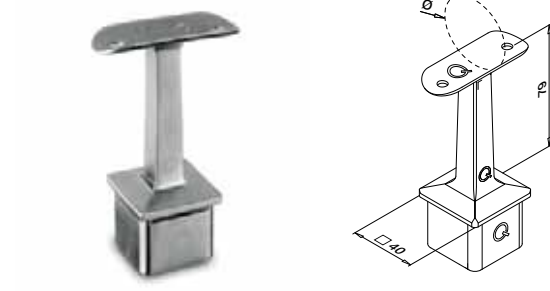

**MOD 4710**

V2A	304	Gebürstet	INDOOR	∅	Für Rohr □	40 x 40 x 2,0	QS-10	474	2
<b>SELL OUT</b>									
V4A	316	Gebürstet	OUTDOOR						
<b>SELL OUT</b>									



Für flaches Rohr

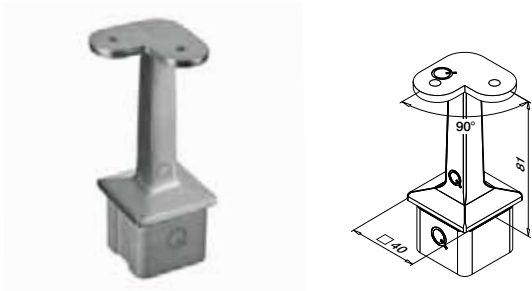

**MOD 4710**

V2A	304	Gebürstet	INDOOR	Für Rohr □	40 x 40 x 2,0	QS-12	474	2
V4A	316	Gebürstet	OUTDOOR					



Für flaches Rohr zu rundem Rohr

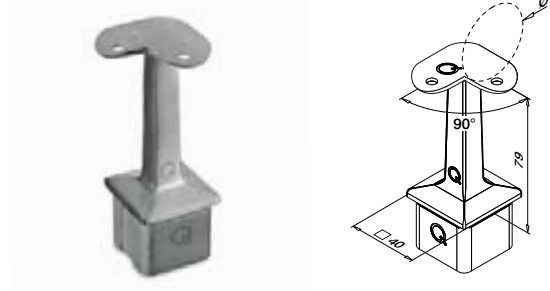

**MOD 4710**

V2A	304	Gebürstet	INDOOR	∅	Für Rohr □	40 x 40 x 2,0	QS-10	474	2
V4A	316	Gebürstet	OUTDOOR						



**Q-INFO** | MOD 4710-000-00 / 4710-04x-00

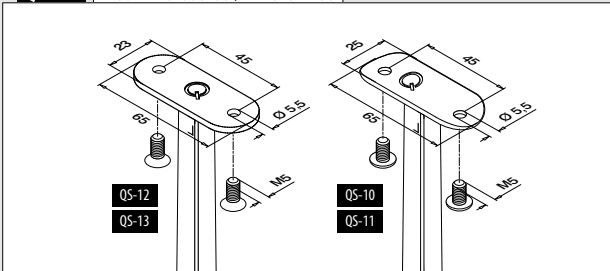

**Q-INFO** | 304

12	82 RAL 9005
Gebürstet	Pulverbeschichtet
	Schwarz, matt, strukturiert

**Q-INFO** | MOD 4710-000-90 / 4710-042-90

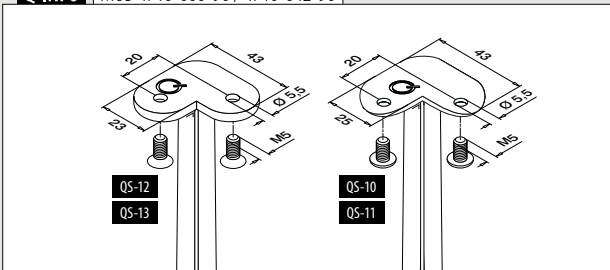

**Q-INFO** | MOD 4710-000-90

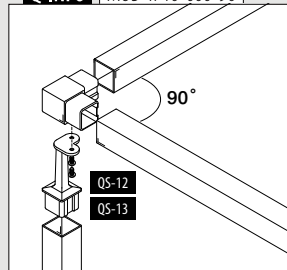

**Q-INFO** | MOD 4710-042-90

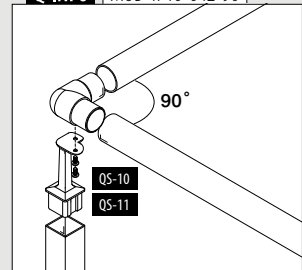



Für flaches Rohr

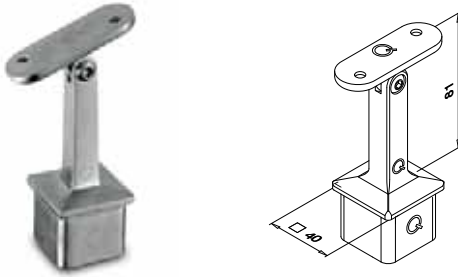

## MOD 4718

V2A	304	Gebürstet			
	<b>INDOOR</b>		<b>Für Rohr</b> □		
	134718-000-12		40 x 40 x 2,0	QS-12	474 2
V4A	316	Gebürstet			
	<b>OUTDOOR</b>				
	144718-000-12		40 x 40 x 2,0	QS-13	474 2



Für flaches Rohr zu rundem Rohr

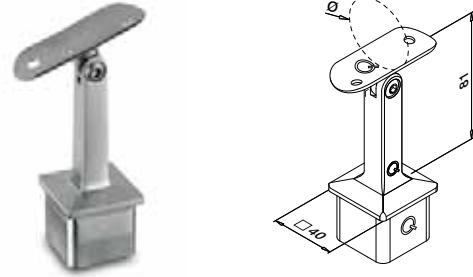

## MOD 4718

V2A	304	Gebürstet			
	<b>INDOOR</b>		<b>Ø</b>	<b>Für Rohr</b> □	
	134718-042-12		42,4	40 x 40 x 2,0	QS-10
<b>SELL OUT</b>	134718-048-12		48,3	40 x 40 x 2,0	QS-10
V4A	316	Gebürstet			
	<b>OUTDOOR</b>				
	144718-042-12		42,4	40 x 40 x 2,0	QS-11



## Q-INFO

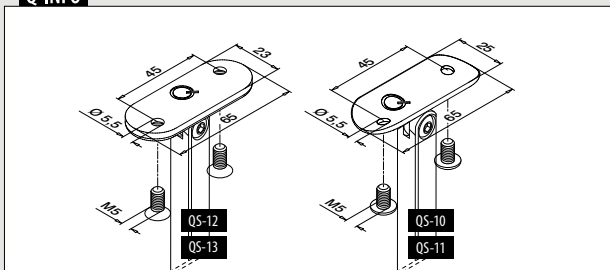

Nur solange der Vorrat reicht.

Für flaches Rohr

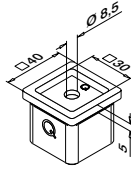

## MOD 4727

V2A	304	Gebürstet			
	<b>INDOOR</b>	<b>Für Rohr</b> <input type="checkbox"/>			
	134727-12	40 x 40 x 2,0	QS-26	474	2
V4A	316	Gebürstet			
	<b>OUTDOOR</b>				
NEW	144727-12	40 x 40 x 2,0	QS-27	474	2

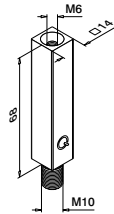

## MOD 4811

V2A	304	Gebürstet			
	<b>INDOOR</b>				
	134811		QS-48	474	2

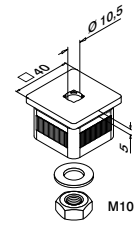
MOD 1810  
 337MOD 1801  
 337MOD 1802  
 337

## MOD 4733- EASY HIT®

V2A	304	Gebürstet			
	<b>INDOOR</b>	<b>Für Rohr</b> <input type="checkbox"/>			
	134733	40 x 40 x 2,0			2



## Q-INFO | MOD 4727

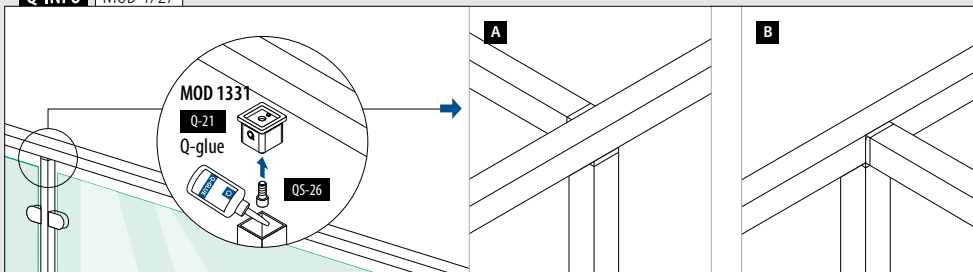

## Q-INFO | MOD 4733 / 4811

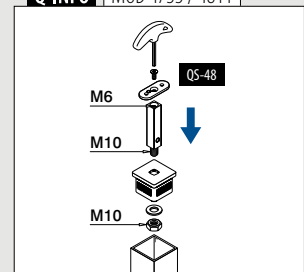

Für flaches Rohr



MOD 4133

V2A	304	Gebürstet		
<b>INDOOR</b>				
SELL OUT	134133-000-12	QS-55 472 / QS-21 474 / QS-12 474		2

Für flaches Rohr  
zu rundem Rohr

MOD 4133

V2A	304	Gebürstet		
<b>INDOOR</b>				
SELL OUT	134133-042-12	42,4 QS-55 472 / QS-21 474 / QS-10 474		2

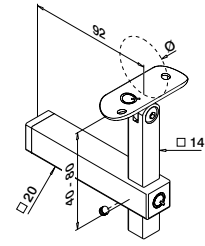

Für flaches Rohr



MOD 4155

V2A	304	Gebürstet		
<b>INDOOR</b>				
SELL OUT	134155-000-12	QS-12 474		2

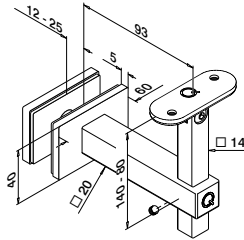

SELL OUT Nur solange der Vorrat reicht.

## Q-INFO

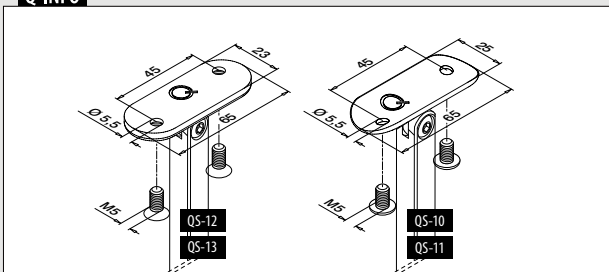

## Q-INFO MOD 4155

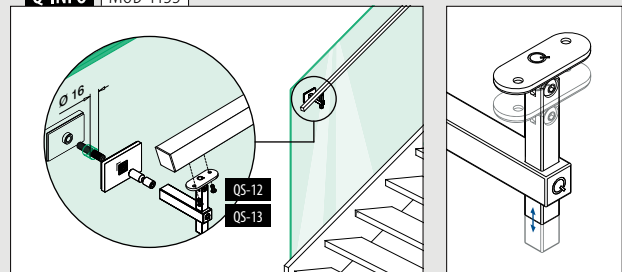

Für flaches Rohr

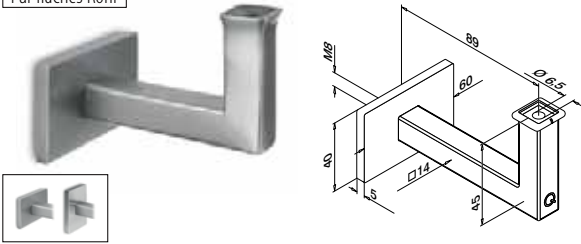

MOD 4111

V2A	304	Gebürstet		
<b>INDOOR</b>				
134111-000-12	QS-1		473 / QS-54	474
				2

V4A	316	Gebürstet		
<b>OUTDOOR</b>				
144111-000-12	QS-2		473 / QS-70	474
				2



Für rundes Rohr

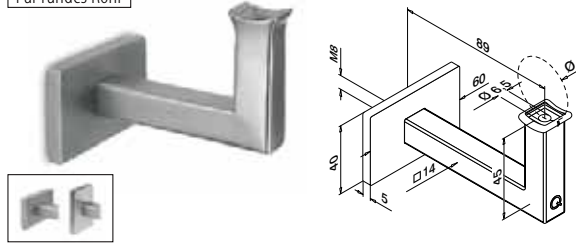

MOD 4111

V2A	304	Gebürstet		
<b>INDOOR</b>				
134111-042-12	42,4	QS-1		473 / QS-54
				474
				2



Q-INFO | MOD 4111-042

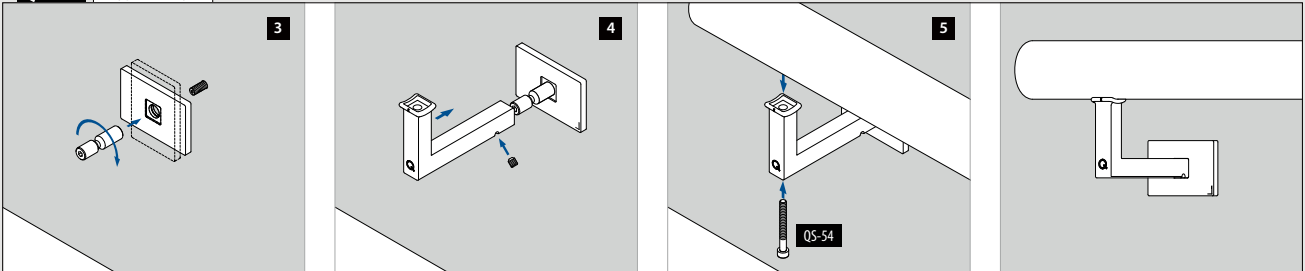

Q-INFO | MOD 4111-042

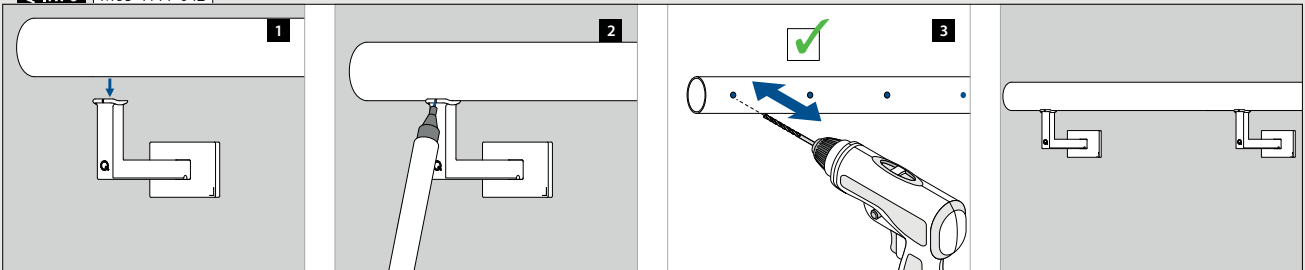

Für flaches Rohr

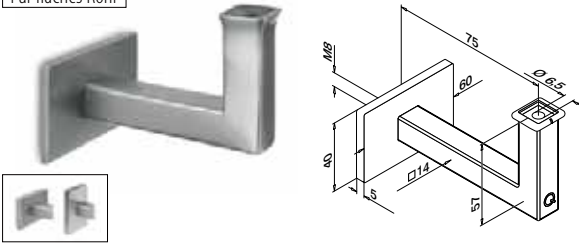

**MOD 4121**

V2A	<b>304</b>	Gebürstet		
<b>INDOOR</b>				
134121-000-12	QS-1	473 / QS-54	474	2

V4A	<b>316</b>	Gebürstet		
<b>OUTDOOR</b>				
144121-000-12	QS-2	473 / QS-70	474	2



Für flaches Rohr

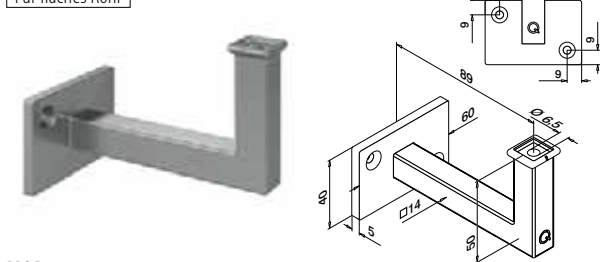

**MOD 4112**

V2A	<b>304</b>	Gebürstet		
<b>INDOOR</b>				
134112-000-12	QS-5	473 / QS-54	474	2

V4A	<b>316</b>	Gebürstet		
<b>OUTDOOR</b>				
<b>NEW</b> 144112-000-12	QS-6	473 / QS-70	474	2



Für flaches Rohr

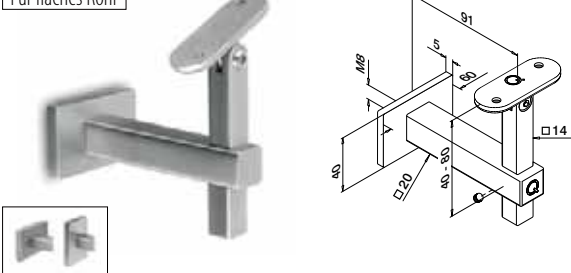

**MOD 4145**

V2A	<b>304</b>	Gebürstet		
<b>INDOOR</b>				
134145-000-12	QS-1	473 / QS-12	474	2

V4A	<b>316</b>	Gebürstet		
<b>OUTDOOR</b>				
<b>SELL OUT</b> 144145-000-12	QS-2	473 / QS-13	474	2



Für rundes Rohr

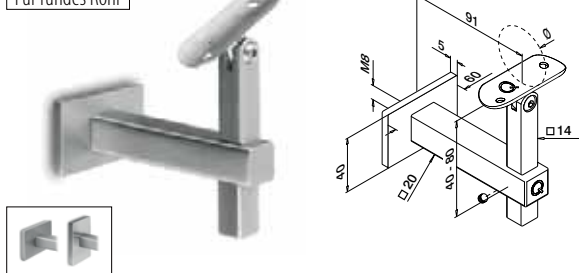

**MOD 4145**

V2A	<b>304</b>	Gebürstet			
<b>INDOOR</b>					
134145-042-12	42,4	QS-1	473 / QS-10	474	2



**Q-INFO** MOD 4145

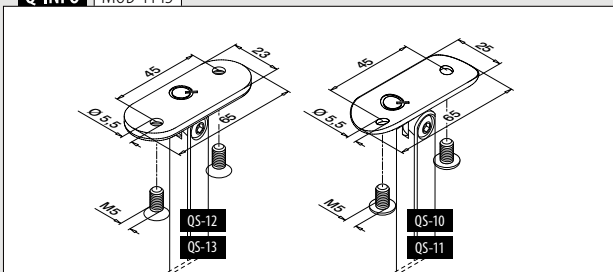

**SELL OUT** Nur solange der Vorrat reicht.



## Endkappen

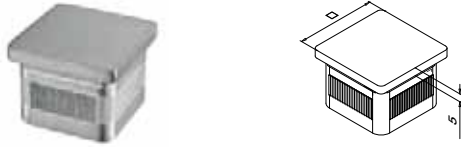

## MOD 5728 - EASY HIT®

V2A	304	Gebürstet		
<b>INDOOR</b>			Für Rohr <input type="checkbox"/>	
135728-040-12	40 x 40 x 2,0			2
V2A	304	Black Line		
<b>INDOOR</b>				
<b>NEW</b> 135728-040-82	40 x 40 x 2,0			2
V4A	316	Gebürstet		
<b>OUTDOOR</b>				
145728-040-12	40 x 40 x 2,0			2



## Rohre

## Q-TUBE

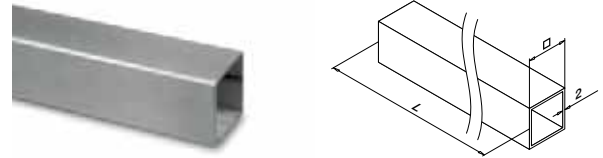

## MOD 4900

V2A	304	Gebürstet		
<b>INDOOR</b>			<input type="checkbox"/>	
134900-040-25-12	40 x 40 x 2,0			L = 2,5 m
134900-040-50-12	40 x 40 x 2,0			L = 5 m
V2A	304	Black Line		
<b>INDOOR</b>				
<b>NEW</b> 134900-040-50-82	40 x 40 x 2,0			L = 5 m
V4A	316	Gebürstet		
<b>OUTDOOR</b>				
144900-040-25-12	40 x 40 x 2,0			L = 2,5 m
144900-040-50-12	40 x 40 x 2,0			L = 5 m



## Verbinder

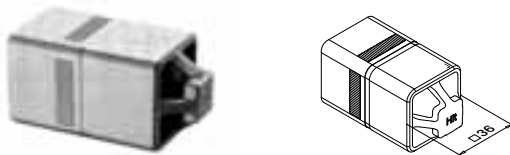

## MOD 5794 - EASY HIT®

V4A	316	Roh		
<b>OUTDOOR</b>			Für Rohr <input type="checkbox"/>	
145794-040	40 x 40 x 2,0			2



Internationaler Geschmacksmusterschutz



## MOD 4790

V2A	304	Gebürstet		
<b>INDOOR</b>			Für Rohr <input type="checkbox"/>	
134790-040-12	40 x 40 x 2,0			2
V4A	316	Gebürstet		
<b>OUTDOOR</b>				
144790-040-12	40 x 40 x 2,0			2



## Q-INFO | MOD 5794-040

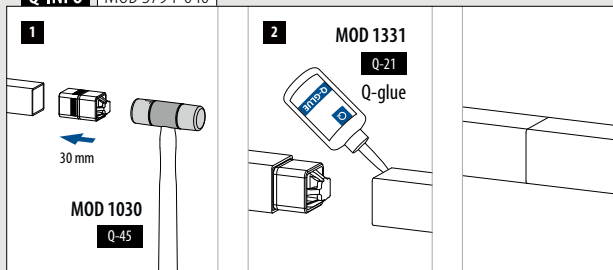

## Q-INFO | MOD 4900

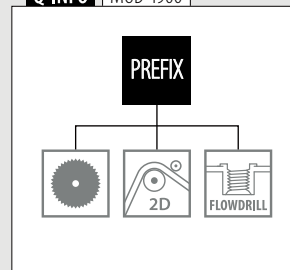

## Q-INFO | 304



Verbinder

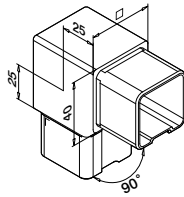

**MOD 4301**

<b>V2A</b>	<b>304</b>	Gebürstet		
	<b>INDOOR</b>	<b>Für Rohr</b> <input type="checkbox"/>		
	134301-040-12	40 x 40 x 2,0		2
<b>V4A</b>	<b>316</b>	Gebürstet		
	<b>OUTDOOR</b>			
	144301-040-12	40 x 40 x 2,0		2

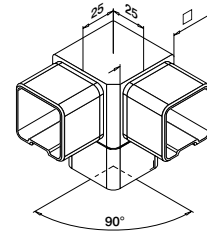

**MOD 4304**

<b>V2A</b>	<b>304</b>	Gebürstet		
	<b>INDOOR</b>	<b>Für Rohr</b> <input type="checkbox"/>		
	134304-12	40 x 40 x 2,0		2
<b>V4A</b>	<b>316</b>	Gebürstet		
	<b>OUTDOOR</b>			
	144304-12	40 x 40 x 2,0		2



Verbinder

Justierbar

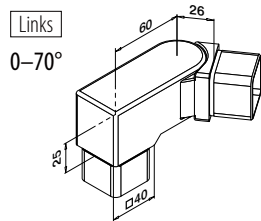

**MOD 4317**

<b>V2A</b>	<b>304</b>	Gebürstet		
	<b>INDOOR</b>	<b>Für Rohr</b> <input type="checkbox"/>		
	134317-01	40 x 40 x 2,0		2

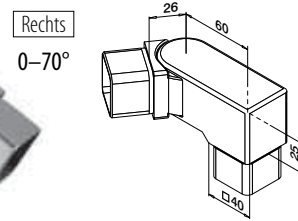

**MOD 4317**

<b>V2A</b>	<b>304</b>	Gebürstet		
	<b>INDOOR</b>	<b>Für Rohr</b> <input type="checkbox"/>		
	134317-02	40 x 40 x 2,0		2

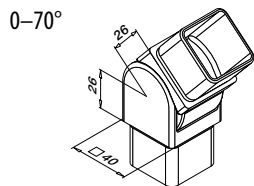

**MOD 4312**

<b>V2A</b>	<b>304</b>	Gebürstet		
	<b>INDOOR</b>	<b>Für Rohr</b> <input type="checkbox"/>		
	134312-040-12	40 x 40 x 2,0		2
<b>V4A</b>	<b>316</b>	Gebürstet		
	<b>OUTDOOR</b>			
	144312-040-12	40 x 40 x 2,0		2



Wandflansche

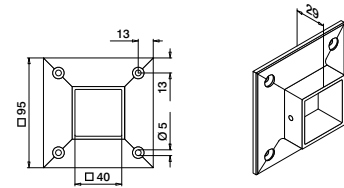

**MOD 4505**

<b>V2A</b>	<b>304</b>	Gebürstet		
	<b>INDOOR</b>	<b>Für Rohr</b> <input type="checkbox"/>		
	134505-040-12	40 x 40 x 2,0	QS-5  473	2
<b>V4A</b>	<b>316</b>	Gebürstet		
	<b>OUTDOOR</b>			
	144505-040-12	40 x 40 x 2,0	QS-6  473	2



**Q-INFO** MOD 4317-01

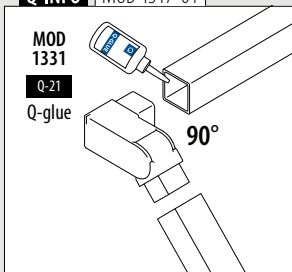

**Q-INFO** MOD 4317-02

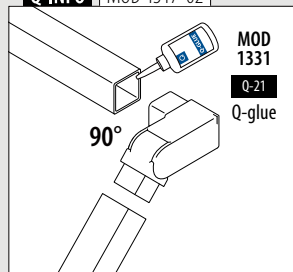



**Beanspruchung:** Leicht bis hoch  
**Verwendung:** Innen- und Außenbereich  
**Montage:** Boden-, In-Boden- und Seitenmontage  
**Anwendung:** Balkone, Galerien, Wege, Abtrennungen, Treppen und Französische Balkone  
**Material:** Edelstahl V4A (gebürstet oder pulverbeschichtet RAL 9005 schwarz)

Finden Sie alle Informationen zu Square Line® 60x30 online:



<https://q-ne.ws/SquareLine63-23>

# SQUARE LINE® 60x30



## Schlichtes Design, außergewöhnlich robust

Square Line® 60x30 besticht durch seinen unverwechselbaren Look - eine ideale Lösung, wenn Sie ausdrucksvolle Akzente setzen möchten. Die Edelstahlpfosten und -handläufe des Systems überzeugen mit ihren einfachen geometrischen Formen und eignen sich für Umgebungen mit hohem Sicherheitsanspruch.

Square Line® 60x30	DE
Max. Holmlast (kN/m)	1,0
Max. Pfostenabstand (Meter)	1,0



Bitte beachten Sie die Spezifikationen wie Befestigungs- und Glasmaße sowie Glastypen der jeweiligen Zertifikate.

### International getestet/berechnet/zertifiziert:



- 1 Der extra starke Pfosten macht Square Line® 60x30 zu einer idealen Lösung, wenn Sie ein robusteres Geländer benötigen.
- 2 Schaffen Sie dank des Industriedesigns einen modernen Look.



## SQUARE LINE® 60x30 FÜLLUNGEN

### Glas

- Glasrahmenrohr
- Glasklemmen
- Glasadapter
- Glashalter



▣ 388 - 392

### Stab und Rohr

- Horizontale Geländerfüllung
- Vertikale Geländerfüllung



▣ 393 - 405

### Drahtseil

- Fast Fix Ø 3,2 mm
- Fast Fix Ø 4,0 mm
- Easy Fix Ø 3,2 mm
- Easy Fix Ø 6,0 mm

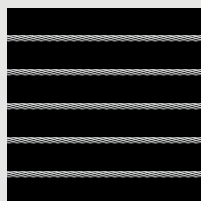

▣ 406 - 413

### Netz

- Easy Q-web

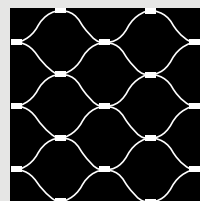

▣ 414 - 417

### Blech

- Blechadapter

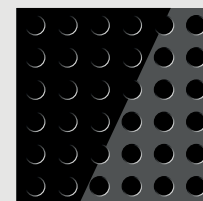

▣ 418 - 421

Geländerpfosten

Geländerpfosten

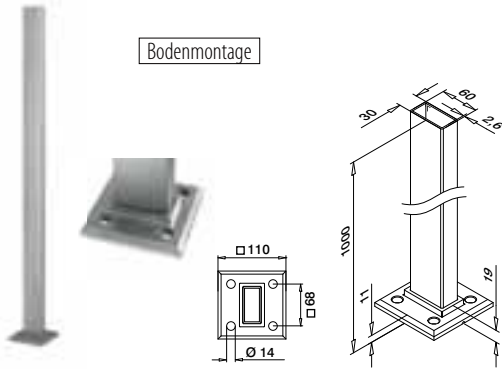

MOD 4901

V4A	316	Gebürstet		
	<b>OUTDOOR</b>			
	144901-063-12	60 x 30 x 2,6	QS-559 467	1
V4A	316	Black Line		
	<b>OUTDOOR</b>			
NEW	144901-063-82	60 x 30 x 2,6	QS-559 467	1



Geländerpfosten

Geländerpfostenrohre

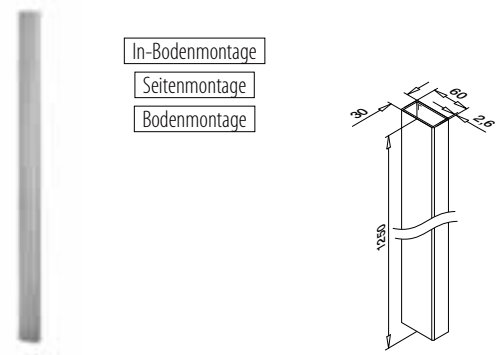

MOD 4902

V4A	316	Gebürstet		
	<b>OUTDOOR</b>			
	144902-063-12	60 x 30 x 2,6		1
	<b>PREFIX</b>			

Geländerpfosten

Abdeckkappen

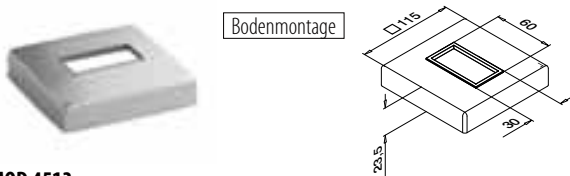

MOD 4513

V4A	316	Gebürstet		
	<b>OUTDOOR</b>			
	144513-063-12			2
V4A	316	Black Line		
	<b>OUTDOOR</b>			
NEW	144513-063-82			2



MOD 4512

V4A	316	Gebürstet		
	<b>OUTDOOR</b>			
	144512-063			2

Geländerpfosten

Bodenflansche für Geländerpfosten

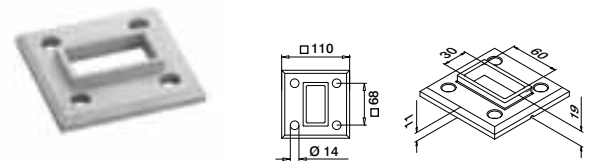

MOD 3503

V4A	316	Roh		
	<b>OUTDOOR</b>			
	143503-063	QS-559 467		2

Q-INFO MOD 4901 / 4902

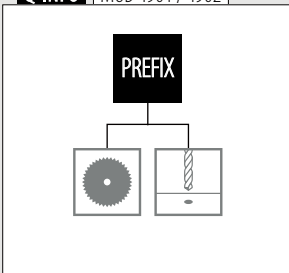

Q-INFO 316



Q-INFO MOD 4901 / 4513

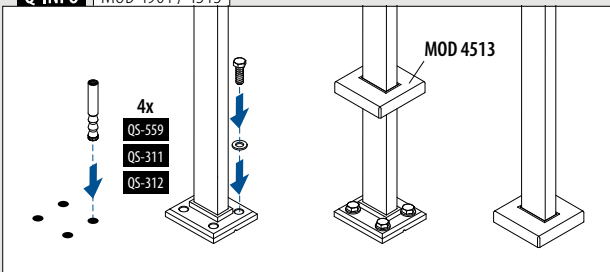

Q-INFO MOD 4902 / 4512

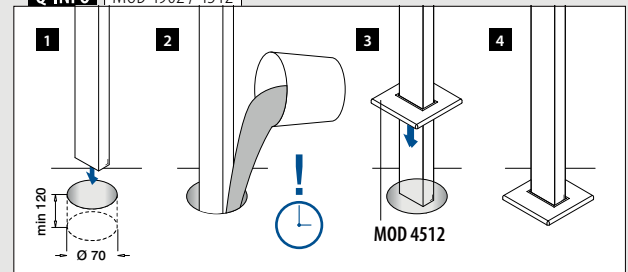



Geländerpfostenhalterungen

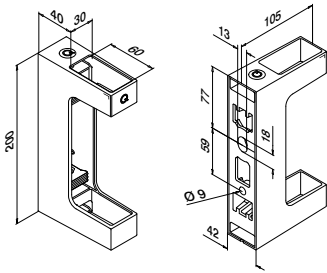

MOD 4558

V4A	316	Gebürstet		
	<b>OUTDOOR</b>			
	14458-063-12	60 x 30	QS-559	467
V4A	316	Black Line		
	<b>OUTDOOR</b>			
NEW	14458-063-82	60 x 30	QS-559	467



Internationaler Geschmacksmusterschutz

Handläufe

Endkappen

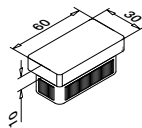

MOD 5728 - EASY HIT®

V4A	316	Gebürstet		
	<b>OUTDOOR</b>		Für	
	14478-063-12	60 x 30 x 2,6		2



Internationaler Geschmacksmusterschutz

Rohre

Q-TUBE

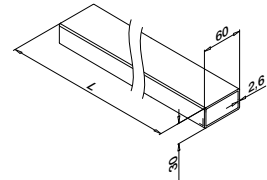

MOD 4900

V4A	316	Gebürstet		
	<b>OUTDOOR</b>			
	14490-063-50-12	60 x 30 x 2,6		L = 5 m



Handläufe

Handlaufadapter

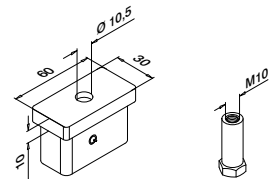

MOD 4725

V4A	316	Gebürstet		
	<b>OUTDOOR</b>		Für	
	14475-12	60 x 30 x 2,6	QS-48	474



	<b>MOD 0811</b>		<b>MOD 0812</b>		<b>MOD 4811</b>
	335		335		296

	<b>MOD 1810</b>		<b>MOD 1801</b>		<b>MOD 1802</b>
	337		337		337

Q-INFO MOD 4725

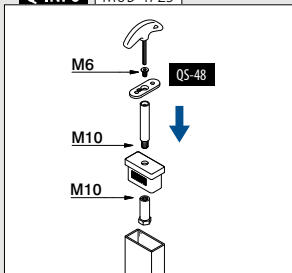

Q-INFO MOD 4900

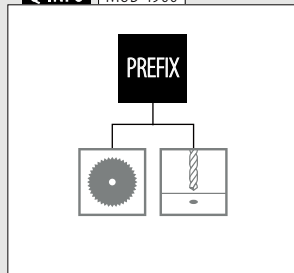

Q-INFO MOD 4558

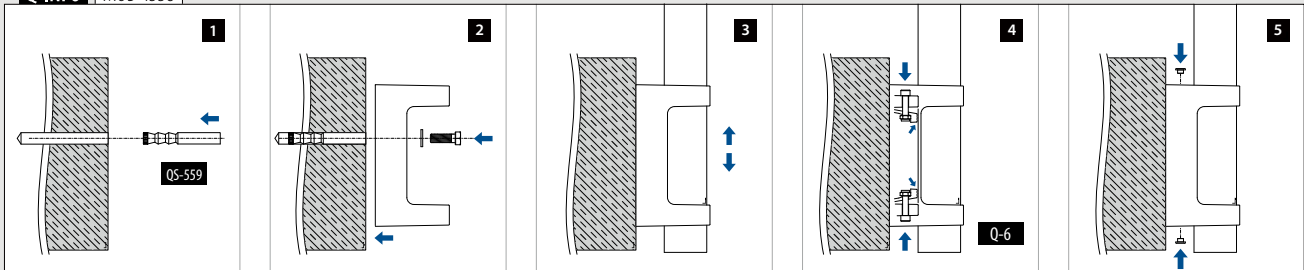

Für flaches Rohr

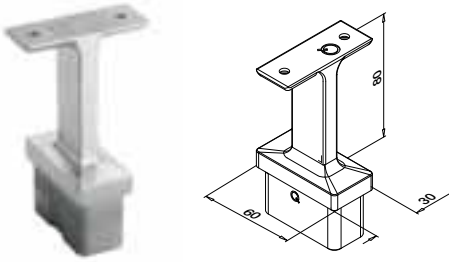

## MOD 4711

V4A	316	Gebürstet	Für □	Ø	MS	MS
	<b>OUTDOOR</b>		60 x 30 x 2,6	QS-13	474	2
V4A	316	<b>Black Line</b>				
	<b>OUTDOOR</b>					
NEW	144711-000-82		60 x 30 x 2,6	QS-13	474	2

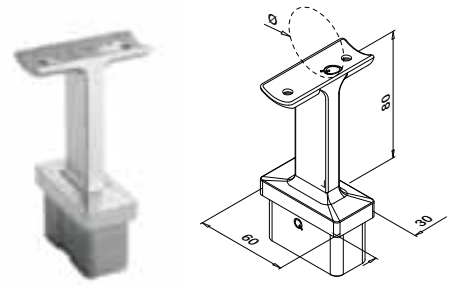
Für flaches Rohr  
zu rundem Rohr

## MOD 4711

V4A	316	Gebürstet	Für □	Ø	MS	MS
	<b>OUTDOOR</b>		60 x 30 x 2,6	42,4	QS-13	474
				48,3	QS-13	474
SELL OUT	144711-042-12					2
						2
V4A	316	<b>Black Line</b>				
	<b>OUTDOOR</b>					
NEW	144711-042-82		60 x 30 x 2,6	QS-13	474	2



Für flaches Rohr

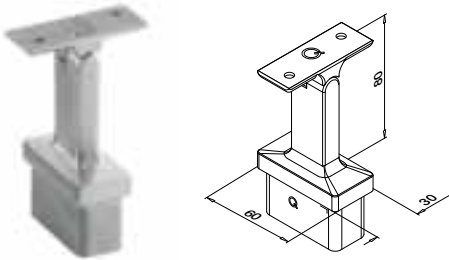

## MOD 4719

V4A	316	Gebürstet	Für □	Ø	MS	MS
	<b>OUTDOOR</b>		60 x 30 x 2,6	QS-13	474	2

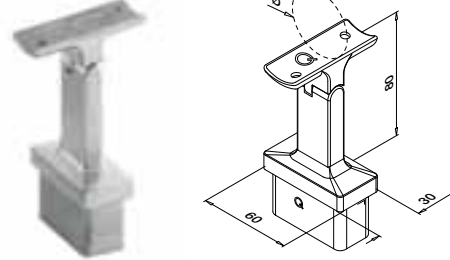
Für flaches Rohr  
zu rundem Rohr

## MOD 4719

V4A	316	Gebürstet	Für □	Ø	MS	MS
	<b>OUTDOOR</b>		60 x 30 x 2,6	42,4	QS-13	474
				48,3	QS-13	474
SELL OUT	144719-042-12					2
						2



SELL  
OUT Nur solange der Vorrat reicht.

## Q-INFO MOD 4711

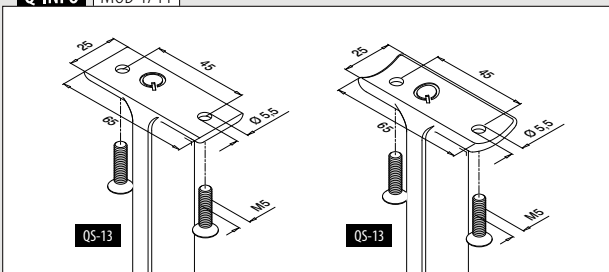

## Q-INFO MOD 4719

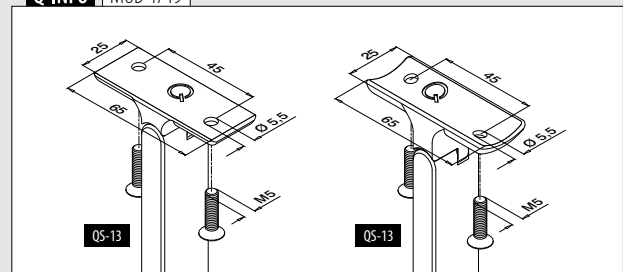

Handläufe

Rohre

Q-TUBE

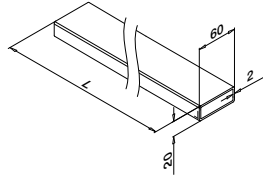

MOD 4900

V4A	316	Gebürstet		
<b>OUTDOOR</b>				
144900-062-25-12	60 x 20 x 2,0		L = 2,5 m	
144900-062-50-12	60 x 20 x 2,0		L = 5 m	

V4A	316	Black Line		
<b>OUTDOOR</b>				
NEW 144900-062-50-82	60 x 20 x 2,0		L = 5 m	



Internationaler Geschmacksmusterschutz

Handläufe

Verbinder

Justierbar



0 - 70°

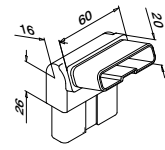

MOD 4312

V4A	316	Gebürstet		
<b>OUTDOOR</b>				
144312-062-12	60 x 20 x 2,0	Für Rohr		2



Internationaler Geschmacksmusterschutz

Handläufe

Verbinder

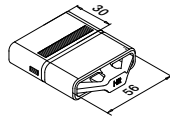

MOD 5794 - EASY HIT®

V4A	316	Roh		
<b>OUTDOOR</b>				
145794-062	60 x 20 x 2,0	Für Rohr		2



Internationaler Geschmacksmusterschutz

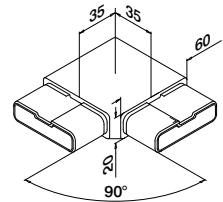

MOD 4301

V4A	316	Gebürstet		
<b>OUTDOOR</b>				
144301-062-12	60 x 20 x 2,0	Für Rohr		2

V4A	316	Black Line		
<b>OUTDOOR</b>				
NEW 144301-062-82	60 x 20 x 2,0			2



Handläufe

Endkappen

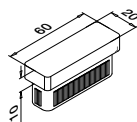

MOD 5728 - EASY HIT®

V4A	316	Gebürstet		
<b>OUTDOOR</b>				
145728-062-12	60 x 20 x 2,0	Für Rohr		2

V4A	316	Black Line		
<b>OUTDOOR</b>				
NEW 145728-062-82	60 x 20 x 2,0			2



Internationaler Geschmacksmusterschutz

Handläufe

Wandflansche

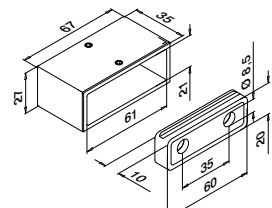

MOD 4504

V4A	316	Gebürstet		
<b>OUTDOOR</b>				
144504-062-12	60 x 20 x 2,0	Für Rohr	QS-55 472 / QS-27 474	2



Q-INFO MOD 5794

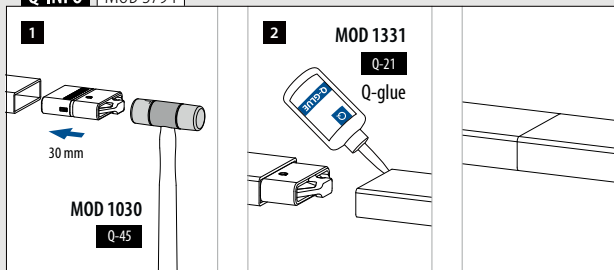

Q-INFO MOD 4900

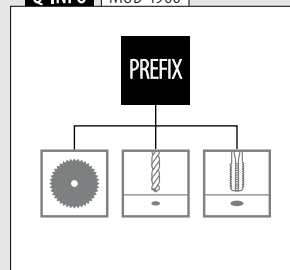

Q-INFO 316



POSTENGELENDERSYSTEME

SQUARE LINE® 60X20





- Beanspruchung:** Leicht bis hoch  
**Verwendung:** Innen- und Außenbereich  
**Montage:** Boden-, In-Boden- und Seitenmontage  
**Anwendung:** Balkone, Galerien, Wege, Abtrennungen, Treppen und Französische Balkone  
**Material:** Edelstahl V2A oder V4A (gebürstet, hochglanzpoliert oder pulverbeschichtet RAL 9005 schwarz)

Finden Sie alle Informationen zu Q-line online:

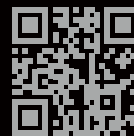

<https://q-ne.ws/QLine23>

Q-LINE



# Ein Geländersystem mit grenzenlosen Gestaltungsmöglichkeiten

Q-line ist zweifellos unser vielseitigstes System. Es umfasst eine große Bandbreite an unterschiedlichen Komponenten, die den meisten architektonischen Herausforderungen gewachsen sind und nahezu jeder Anforderung gerecht werden. Sie können sogar ein Geländer mit einer komplett hochglanzpolierten Oberfläche erstellen. Oder wie wäre es, wenn Sie einige Elemente aus anderen Serien integrieren, um ein wirklich einzigartiges Design zu schaffen? Lassen Sie Ihrer Kreativität freien Lauf!

<b>Q-line</b>	<b>DE</b>
Max. Holmlast (kN/m) (extra strong)	1,0



Bitte beachten Sie die Spezifikationen wie Befestigungs- und Glasmaße sowie Glastypen der jeweiligen Zertifikate.

### International getestet/berechnet/zertifiziert:



- Das Q-line Sortiment ist äußerst vielseitig – es stehen neben unterschiedlichen Füllungen und Oberflächenausführungen auch verschiedene Lösungen für die Boden- und Seitenmontage sowie Treppen zur Auswahl.
- Im Q-line Sortiment finden Sie auch einen doppelwandigen Pfosten (Boden- und Seitenmontage), mit dem Sie ein rundes Geländer errichten können, das Holmlasten von bis zu 1,0 kN/m standhält.

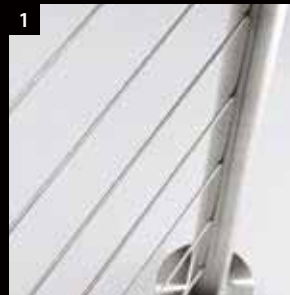

## Q-LINE FÜLLUNGEN

### Glas

- Glasrahmenrohr
- Glasklemmen
- Glasadapter
- Glashalter



▣ 388 - 392

### Stab und Rohr

- Horizontale Geländerfüllung
- Vertikale Geländerfüllung



▣ 393 - 405

### Drahtseil

- Fast Fix Ø 3,2 mm
- Fast Fix Ø 4,0 mm
- Easy Fix Ø 3,2 mm
- Easy Fix Ø 6,0 mm

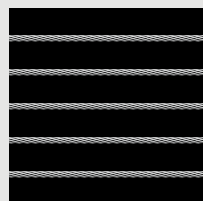

▣ 406 - 413

### Netz

- Easy Q-web

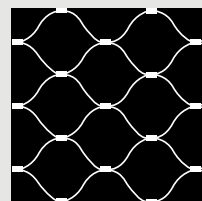

▣ 414 - 417

### Blech

- Blechadapter

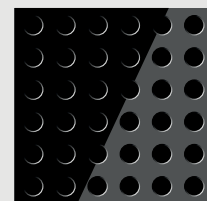

▣ 418 - 421



## Geländerpfosten

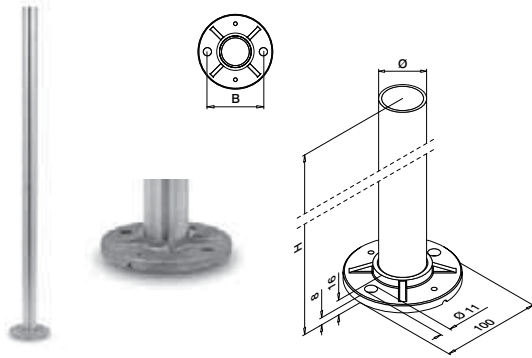

## MOD 0921

V2A	304	Gebürstet	Ø	H	B		
			42,4 x 2,0	989	75	QS-59	469 1
			48,3 x 2,0	989	80	QS-59	469 1

V4A	316	Gebürstet	Ø	H	B		
			42,4 x 2,0	989	75	QS-58	469 1
			48,3 x 2,0	989	80	QS-58	469 1

V4A	316	Hochglanzpoliert	Ø	H	B		
			42,4 x 2,0	989	75	QS-58	469 1

## MOD 0944

V4A	316	Gebürstet	Ø	H	B		
			42,4 x 2,0	1150	75	QS-58	469 1
			48,3 x 2,0	1150	80	QS-58	469 1

PREFIX



## Bodenflansche für Geländerpfosten

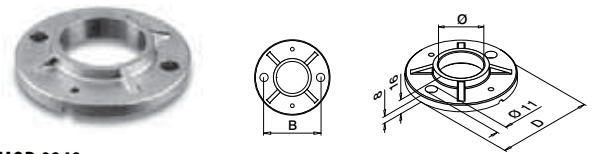

## MOD 0940

V2A	304	Roh	Ø	B	D		
			42,4	75	100	QS-59	469 2
			48,3	80	100	QS-59	469 2

V4A	316	Roh	Ø	B	D		
			42,4	75	100	QS-58	469 2
			48,3	80	100	QS-58	469 2

## MOD 0941

V4A	316	Roh	Ø	B	D		
			48,3	90	120	QS-58	469 2



## Abdeckkappen



## MOD 0512

V2A	304	Gebürstet	Ø	D	
			42,4	105	2
			48,3	105	2

V4A	316	Gebürstet	Ø	D	
			42,4	105	2
			48,3	105	2

V4A	316	Hochglanzpoliert	Ø	D	
			42,4	105	2

## MOD 0513

V4A	316	Gebürstet	Ø	D	
			48,3	125	2

## Q-INFO 316

10

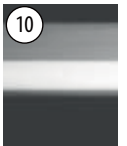
Hochglanz-  
poliert

12



Gebürstet

## Geländerpfosten

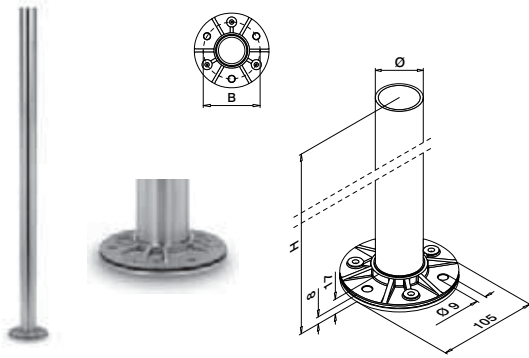

## MOD 0912

V2A	304	Gebürstet
-----	-----	-----------

INDOOR	Ø	H	B		
130912-242-12	42,4 x 2,0	989	80	QS-35	469 1

V4A	316	Gebürstet
-----	-----	-----------

OUTDOOR	Ø	H	B		
140912-242-12	42,4 x 2,0	989	80	QS-34	469 1

PREFIX



## Bodenflansche für Geländerpfosten

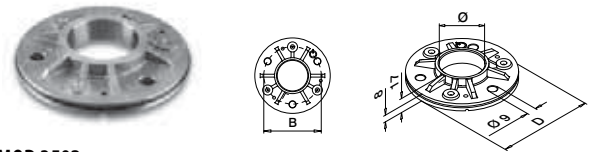

## MOD 3502

V2A	304	Roh
-----	-----	-----

INDOOR	Ø	B	D		
133502-042	42,4	80	105	QS-35	469 2
133502-048	48,3	90	115	QS-35	469 2

V4A	316	Roh
-----	-----	-----

## OUTDOOR

143502-042	42,4	80	105	QS-34	469 2
143502-048	48,3	90	115	QS-34	469 2



## Abdeckkappen

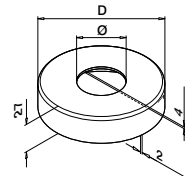

## MOD 0511

V2A	304	Gebürstet
-----	-----	-----------

INDOOR	Ø	D	
130511-042-12	42,4	110	2
130511-048-12	48,3	120	2

V4A	316	Gebürstet
-----	-----	-----------

## OUTDOOR

140511-042-12	42,4	110	2
140511-048-12	48,3	120	2

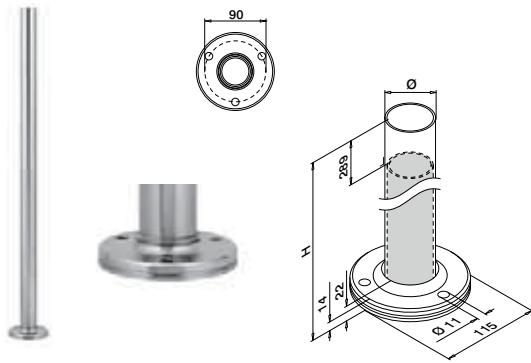

MOD 0916 - DOPPELTE WANDSTÄRKE 4,6 mm

V2A	304	Gebürstet	INDOOR	Ø	H			
130916-548-12	48,3 x 4,6	989	QS-272	466	1			

V4A	316	Gebürstet	OUTDOOR	Ø	H			
140916-548-12	48,3 x 4,6	989	QS-273	466	1			

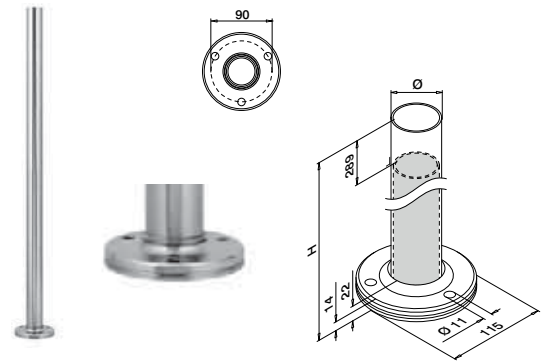

MOD 0917 - DOPPELTE WANDSTÄRKE 4,6 mm

V4A	316	Gebürstet	OUTDOOR	Ø	H			
140917-548-12	48,3 x 4,6	1089	QS-273	466	1			

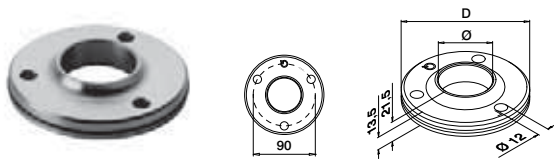

MOD 3505

V4A	316	Roh	OUTDOOR	Ø	D			
143505-048	48,3	115	QS-273	466	2			

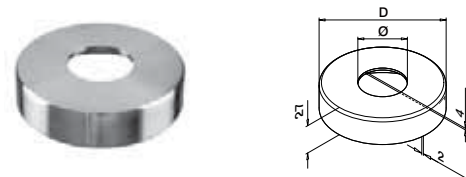

MOD 0511

V2A	304	Gebürstet	INDOOR	Ø	D			
130511-048-12	48,3	120	2					

V4A	316	Gebürstet	OUTDOOR	Ø	D			
140511-048-12	48,3	120	2					

## Q-INFO | MOD 0916 / 0917

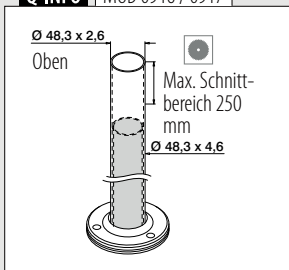

## Q-INFO | MOD 0916 / 0917

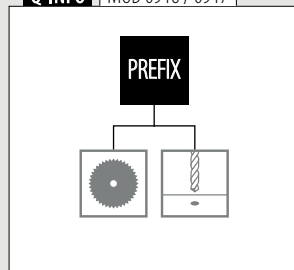

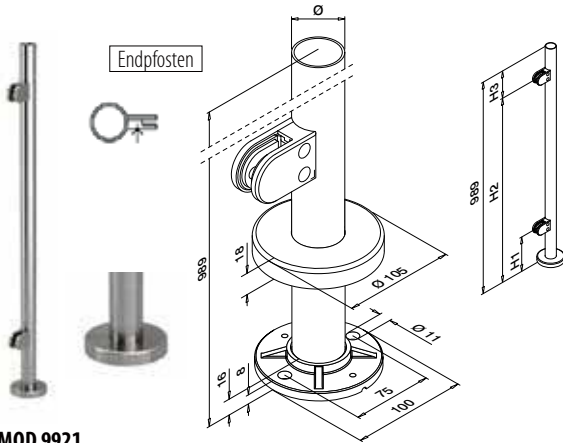

MOD 9921

V2A	304	Gebürstet						
<b>INDOOR</b>			Ø	H1	H2	H3		
139921-242-01-12	42,4 x 2,0	175	869	120	QS-59	469	1	

V4A	316	Gebürstet						
<b>OUTDOOR</b>								
NEW 149921-242-01-12	42,4 x 2,0	175	869	120	QS-58	469	1	

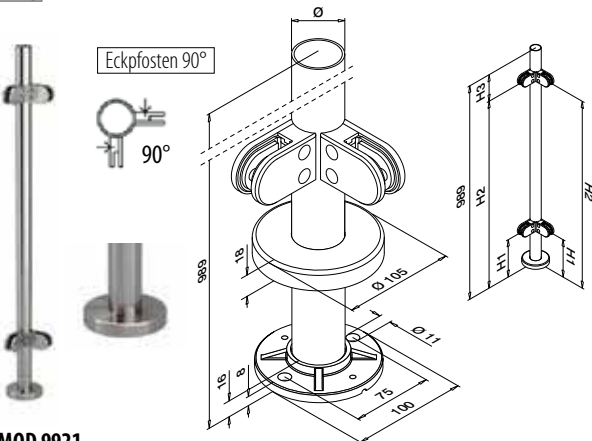

MOD 9921

V2A	304	Gebürstet						
<b>INDOOR</b>			Ø	H1	H2	H3		
139921-242-90-12	42,4 x 2,0	175	869	120	QS-59	469	1	

V4A	316	Gebürstet						
<b>OUTDOOR</b>								
NEW 149921-242-90-12	42,4 x 2,0	175	869	120	QS-58	469	1	

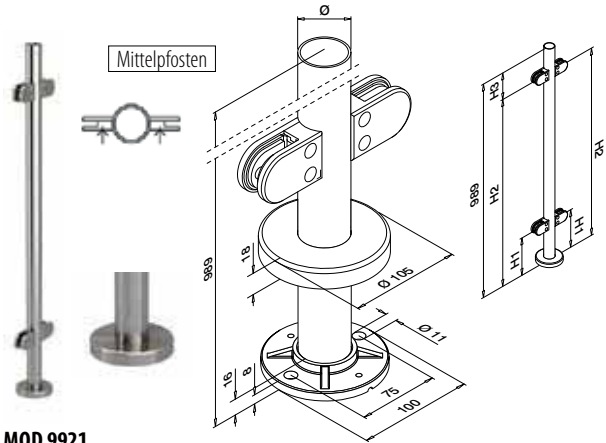

MOD 9921

V2A	304	Gebürstet						
<b>INDOOR</b>			Ø	H1	H2	H3		
139921-242-02-12	42,4 x 2,0	175	869	120	QS-59	469	1	

V4A	316	Gebürstet						
<b>OUTDOOR</b>								
NEW 149921-242-02-12	42,4 x 2,0	175	869	120	QS-58	469	1	



Füllungen

Gummieinlagen für Glasklemmen MOD 2500



2 Stück pro Glasklemme

MOD 5025

Zubehör

Für monolithisches Glas	T	
205025-06	6	8
205025-08	8	8
205025-10	10	8
205025-12	12	8

Für laminiertes Glas

205025-07	6,76	8
205025-09	8,76	8
NEW 205025-44	9,52	8
205025-11	10,76	8
NEW 205025-54	11,52	8
205025-13	12,76	8



MOD 0710  
324



MOD 0718  
326



MOD 5015  
476

Q-INFO

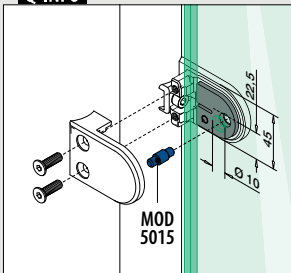

Q-INFO

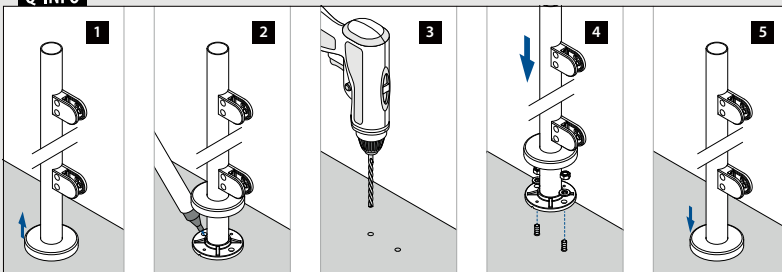

Q-INFO

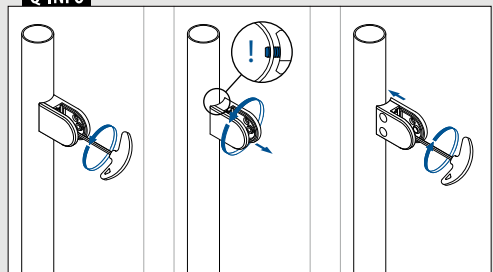

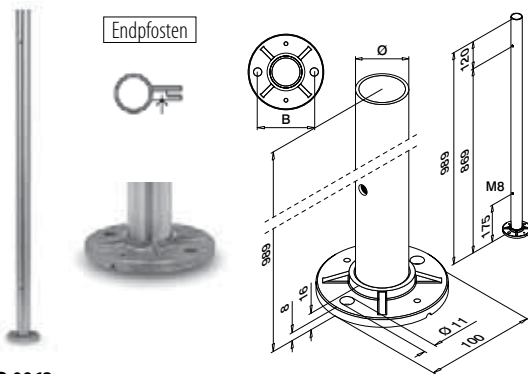

MOD 0962

V4A	316	Gebürstet			
OUTDOOR			Ø	B	
140962-242-01-12	42,4 x 2,0	75	QS-58	469	1
140962-248-01-12	48,3 x 2,0	80	QS-58	469	1

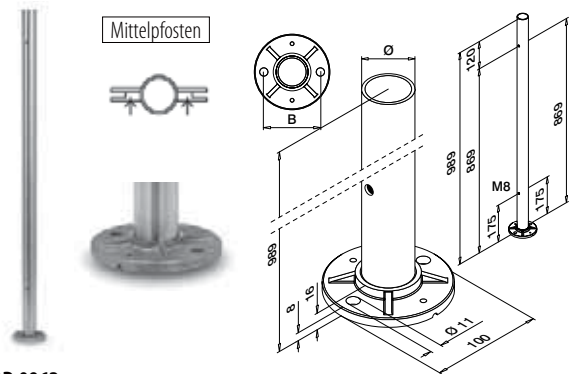

MOD 0962

V4A	316	Gebürstet			
OUTDOOR			Ø	B	
140962-242-02-12	42,4 x 2,0	75	QS-58	469	1
140962-248-02-12	48,3 x 2,0	80	QS-58	469	1

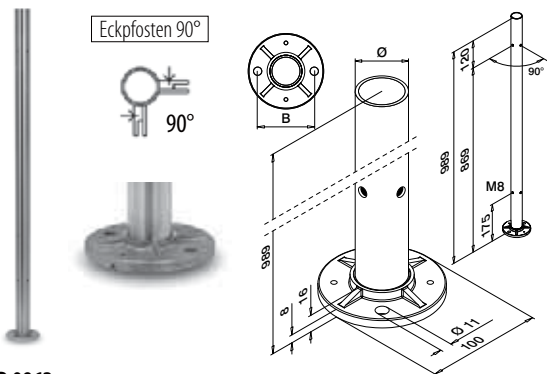

MOD 0962

V4A	316	Gebürstet			
OUTDOOR			Ø	B	
140962-242-90-12	42,4 x 2,0	75	QS-58	469	1
140962-248-90-12	48,3 x 2,0	80	QS-58	469	1

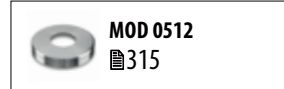
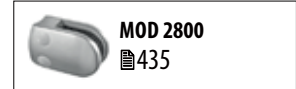
MOD 0512  
Ø 315MOD 2800  
Ø 435

## Q-INFO | MOD 0962

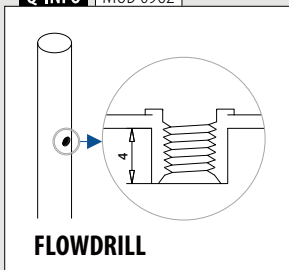

FLOWDRILL

## Q-INFO



Schauen Sie sich unsere Prefix-Optionen für Geländerpfosten mit Glasklemmen, Querstab-, Drahtseil- und Netzhaltern an.



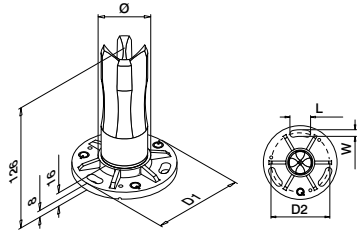

**MOD 0942**

V2A	304	Gebürstet							
INDOOR			Ø	D1	D2	W x L			
	130942-233		33,7 x 2,0	100	80	9x28	QS-35	469	2
	130942-242		42,4 x 2,0	100	80	9x28	QS-35	469	2
	130942-248		48,3 x 2,0	100	80	9x28	QS-35	469	2
SELL OUT	130942-060		60,3 x 2,0	120	90	11x30	QS-35	469	2
V4A	316	Gebürstet							
OUTDOOR			Ø	D1	D2	W x L			
	140942-233		33,7 x 2,0	100	80	9x28	QS-34	469	2
	140942-242		42,4 x 2,0	100	80	9x28	QS-34	469	2
	140942-248		48,3 x 2,0	100	80	9x28	QS-34	469	2



Internationaler Geschmacksmusterschutz

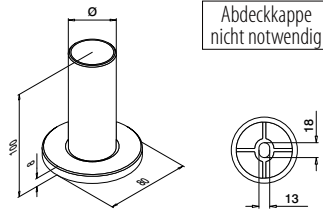

**MOD 0946**

V2A	304	Gebürstet						
INDOOR			Ø			W x L		
	130946-242-12		42,4 x 2,0			QS-33	466	2

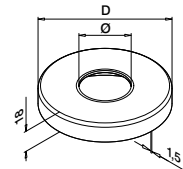

**MOD 0512**

V2A	304	Gebürstet			
INDOOR		Ø	D		
	130512-033-12		33,7	105	2
	130512-042-12		42,4	105	2
	130512-048-12		48,3	105	2

V4A	316	Gebürstet			
OUTDOOR		Ø	D		
	140512-033-12		33,7	105	2
	140512-042-12		42,4	105	2
	140512-048-12		48,3	105	2

V4A	316	Hochglanzpoliert			
OUTDOOR		Ø	D		
	140512-042-10		42,4	105	2

**MOD 0513**

V2A	304	Gebürstet			
INDOOR		Ø	D		
	130513-042-12		42,4	125	2
	130513-048-12		48,3	125	2
SELL OUT	130513-060-12		60,3	125	2

V4A	316	Gebürstet			
OUTDOOR		Ø	D		
	140513-042-12		42,4	125	2
	140513-048-12		48,3	125	2

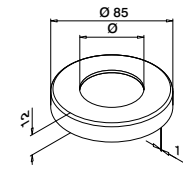

**MOD 0516**

V2A	304	Gebürstet			
INDOOR		Ø			
	130516-033		33,7	2	
	130516-042		42,4	2	

**Q-INFO** MOD 0942

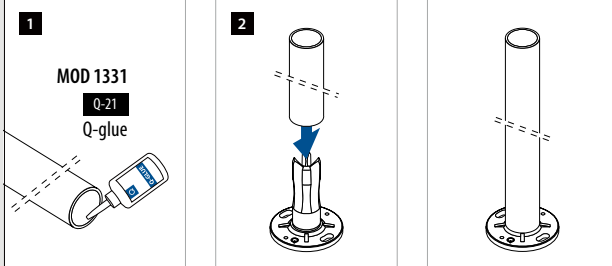

**Q-INFO** MOD 0946

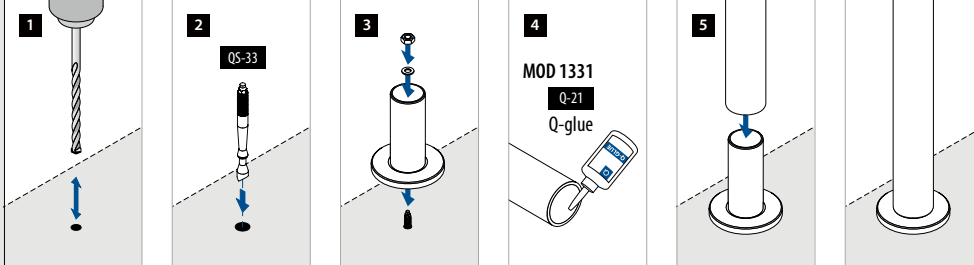

**Q-INFO** 316

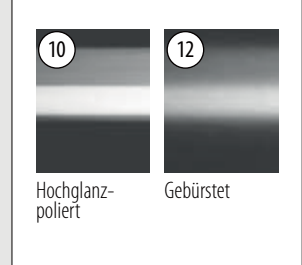

SELL OUT Nur solange der Vorrat reicht.

Bodenflansche

Neigung einstellbar Für Aufsteckrohre



+45°  
-45°

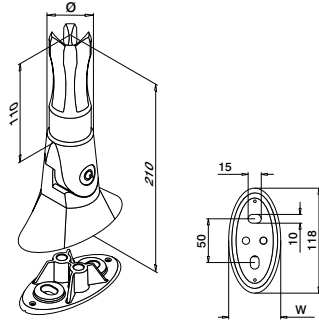

MOD 0945

V2A	304	Gebürstet			
INDOOR		Ø	W		
130945-242	42,4 x 2,0	59	QS-65	466	1
130945-248	48,3 x 2,0	65	QS-65	466	1

V4A	316	Gebürstet			
OUTDOOR					
140945-242	42,4 x 2,0	59	QS-64	466	1



Geländerpfostenrohre

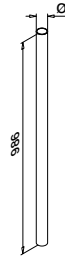

MOD 0901

V2A	304	Gebürstet			
INDOOR		Ø			
130901-242-12	42,4 x 2,0				1

PREFIX

Q-INFO MOD 0901

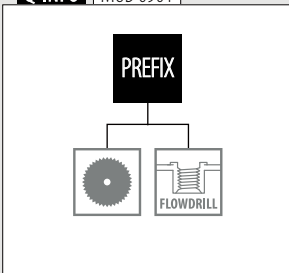

Q-INFO MOD 0945

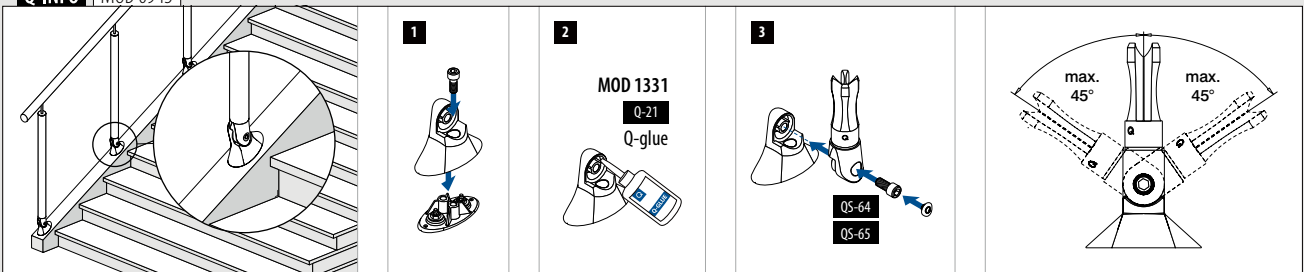

Geländerpfostenhalterungen

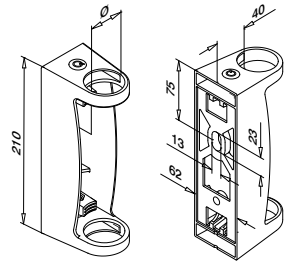
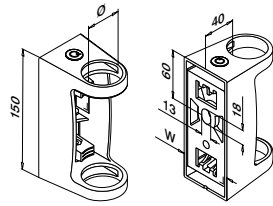

**MOD 0557**

V2A	304	Gebürstet			
<b>INDOOR</b>					
130557-042-12	42,4	QS-33	466	1	
130557-048-12	48,3	QS-33	466	1	
<b>V4A</b>					
<b>316</b>					
<b>OUTDOOR</b>					
140557-042-12	42,4	QS-32	466	1	
140557-048-12	48,3	QS-32	466	1	



Internationaler Geschmacksmusterschutz

**MOD 0558**

V2A	304	Gebürstet			
<b>INDOOR</b>					
130558-048-12	48,3	QS-33	466	1	
<b>V4A</b>					
<b>316</b>					
<b>OUTDOOR</b>					
140558-048-12	48,3	QS-275	466	1	



Internationaler Geschmacksmusterschutz

Geländerpfostenhalterungen

Neigung einstellbar

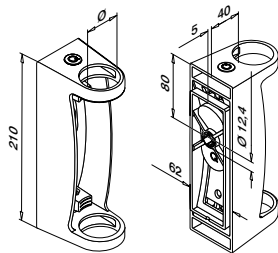

**MOD 0556**

V2A	304	Gebürstet			
<b>INDOOR</b>					
130556-042	42,4	QS-505	467 / QS-551	474	1



Internationaler Geschmacksmusterschutz

**Q-INFO** MOD.0557 / 0558

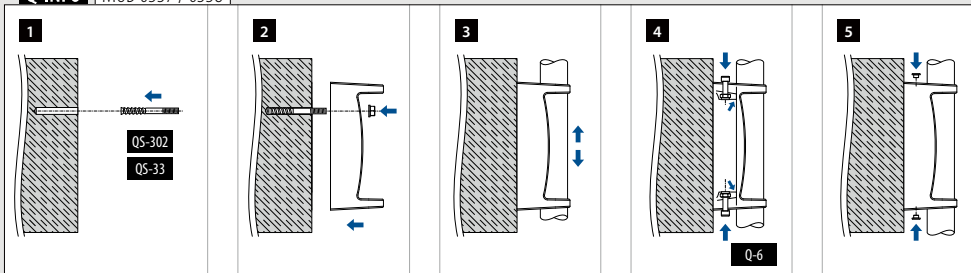

**Q-INFO** MOD.0556

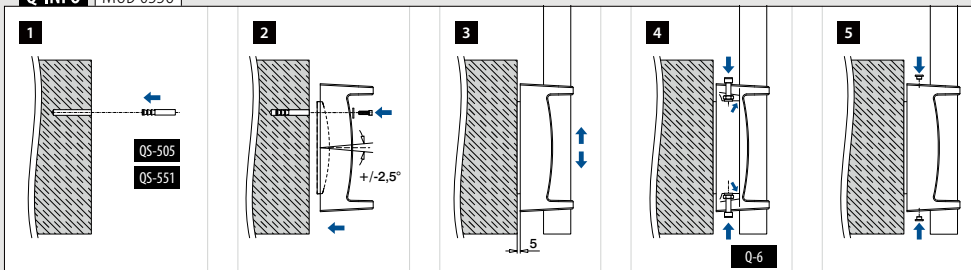

Geländerpfostenhalterungen

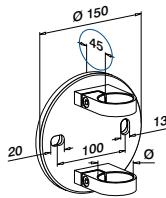

**MOD 0551**

<b>V2A</b>	<b>304</b>	Gebürstet			
<b>INDOOR</b>					
		Ø			
130551-042-12	42,4	QS-33	466	1	

<b>V2A</b>	<b>304</b>	Hochglanzpoliert			
<b>INDOOR</b>					
<b>SELL OUT</b>	130551-042-10	42,4	QS-33	466	1

<b>V4A</b>	<b>316</b>	Gebürstet			
<b>OUTDOOR</b>					
	140551-042-12	42,4	QS-32	466	1
	140551-048-12	48,3	QS-32	466	1

<b>V4A</b>	<b>316</b>	Hochglanzpoliert			
<b>OUTDOOR</b>					
	140551-042-10	42,4	QS-32	466	1

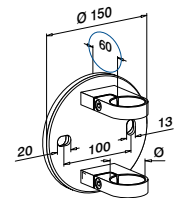

**MOD 0552**

<b>V4A</b>	<b>316</b>	Gebürstet			
<b>OUTDOOR</b>					
	140552-042-12	42,4	QS-32	466	1
	140552-048-12	48,3	QS-32	466	1



**MOD 0550**

<b>V2A</b>	<b>304</b>	Gebürstet			
<b>INDOOR</b>					
	130550-042-12	42,4		2	
	130550-048-12	48,3		2	

<b>V4A</b>	<b>316</b>	Gebürstet			
<b>OUTDOOR</b>					
	140550-042-12	42,4		2	
	140550-048-12	48,3		2	



Innen- und Außenecke

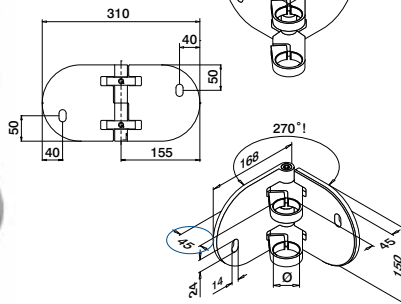

**MOD 0555**

<b>V2A</b>	<b>304</b>	Gebürstet			
<b>INDOOR</b>					
	130555-042-12	42,4	QS-33	466	1

<b>V4A</b>	<b>316</b>	Gebürstet			
<b>OUTDOOR</b>					
	140555-042-12	42,4	QS-32	466	1
	140555-048-12	48,3	QS-32	466	1

<b>V4A</b>	<b>316</b>	Hochglanzpoliert			
<b>OUTDOOR</b>					
	140555-042-10	42,4	QS-32	466	1



**SELL OUT** Nur solange der Vorrat reicht.

**Q-INFO** MOD 0551 / 0552 / 0555



**Q-INFO** 316

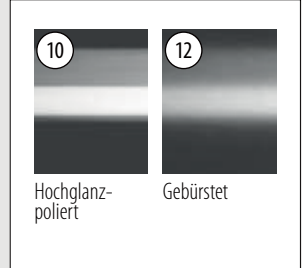

**Q-INFO** MOD 0551 / 0552 / 0555

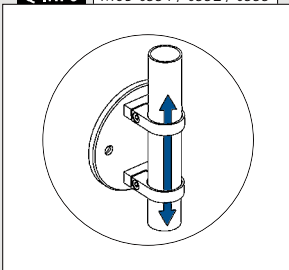

**Q-INFO** MOD 0551 / 0552

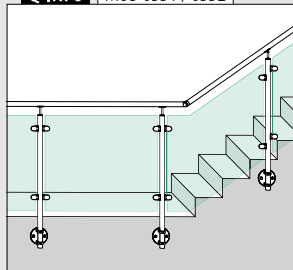

**Q-INFO** MOD 0550

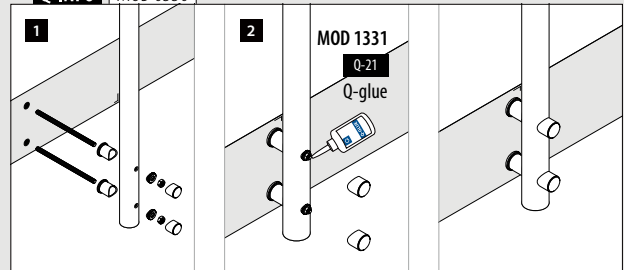

Geländerpfostenhalterungen

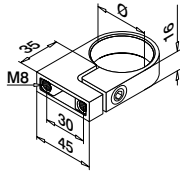

**MOD 3507**

<b>V2A</b>	<b>304</b>	Gebürstet	
<b>INDOOR</b>		∅	
133507-033-12	33,7		2



Nicht kombinierbar mit MOD 3508

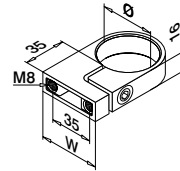

**MOD 3507**

<b>V2A</b>	<b>304</b>	Gebürstet	
<b>INDOOR</b>		∅	<b>W</b>
133507-042-12	42,4	50	2
133507-048-12	48,3	55	2

<b>V4A</b>	<b>316</b>	Gebürstet	
<b>OUTDOOR</b>			
143507-042-12	42,4	50	2
143507-048-12	48,3	55	2



Grundplatten für MOD 3507



Seitenmontage  
Für MOD 3507-04x  
Befestigungsmaterial für MOD 3507-04x ist enthalten

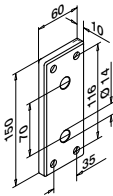

**MOD 3508**

<b>V2A</b>	<b>304</b>	Gebürstet	
<b>INDOOR</b>			
133508-156-12	459 - 465		1

<b>V4A</b>	<b>316</b>	Gebürstet	
<b>OUTDOOR</b>			
143508-156-12	459 - 465		1



Seitenmontage  
Für MOD 3507-04x  
Befestigungsmaterial für MOD 3507-04x ist enthalten

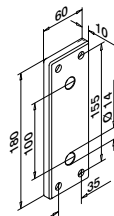

**MOD 3508**

<b>V2A</b>	<b>304</b>	Gebürstet	
<b>INDOOR</b>			
133508-186-12	459 - 465		1

<b>V4A</b>	<b>316</b>	Gebürstet	
<b>OUTDOOR</b>			
143508-186-12	459 - 465		1



Seitenmontage  
Für MOD 3507-04x  
Befestigungsmaterial für MOD 3507-04x ist enthalten

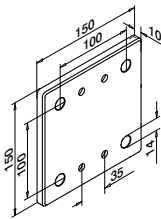

**MOD 3508**

<b>V2A</b>	<b>304</b>	Gebürstet	
<b>INDOOR</b>			
133508-151-12	459 - 465		1

<b>V4A</b>	<b>316</b>	Gebürstet	
<b>OUTDOOR</b>			
143508-151-12	459 - 465		1



**Q-INFO** | MOD 3508-156 / 3507

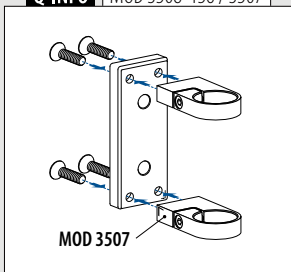

**Q-INFO** | MOD 3508-186 / 3507

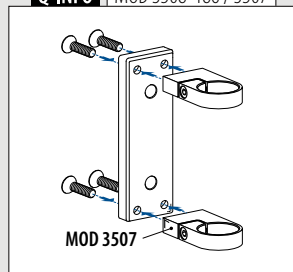

**Q-INFO** | MOD 3508-151 / 3507

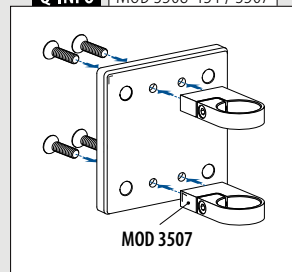



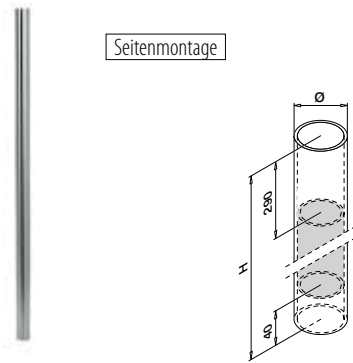

Seitenmontage

**MOD 0951 - DOPPELTE WANDSTÄRKE 4,6 mm**

V2A	304	Gebürstet	INDOOR	Ø	H	317
130951-548-12	48,3 x 4,6	1250	1			
V4A	316	Gebürstet	OUTDOOR	Ø	H	317
140951-548-12	48,3 x 4,6	1250	1			

EXTRA STRONG PREFIX

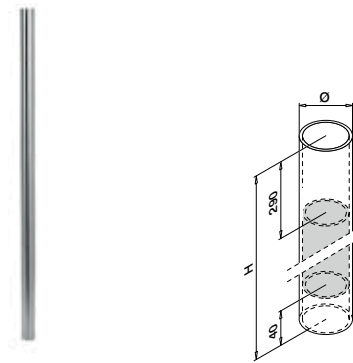
**MOD 0558**  
317**MOD 5735-048**  
336**MOD 0713**  
324**MOD 0721**  
326**MOD 0773**  
333**MOD 0952 - DOPPELTE WANDSTÄRKE 4,6 mm**

V2A	304	Gebürstet	INDOOR	Ø	H	317
130952-548-12	48,3 x 4,6	1350	1			
V4A	316	Gebürstet	OUTDOOR	Ø	H	317
140952-548-12	48,3 x 4,6	1350	1			

EXTRA STRONG PREFIX

## Q-INFO

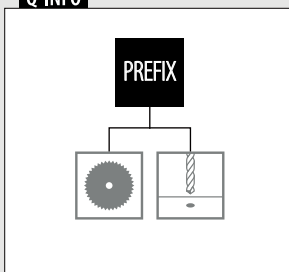

## Q-INFO

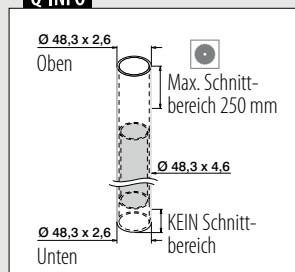

## Q-INFO

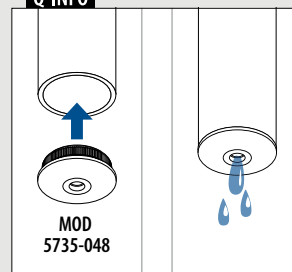

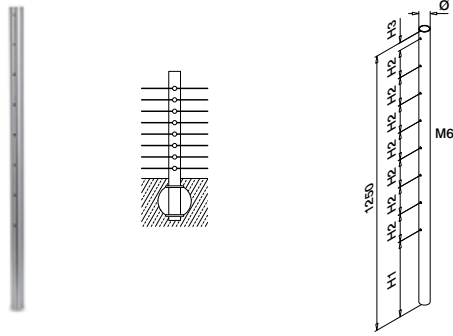

MOD 0935

V2A	304	Gebürstet					
	INDOOR	Ø	H1	H2	H3		
130935-242-00-12	42,4 x 2,0	340	125	35	1		

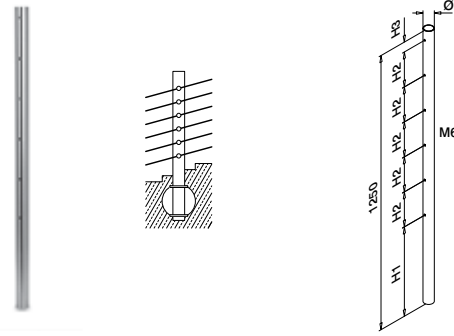

MOD 0935

V2A	304	Gebürstet					
	INDOOR	Ø	H1	H2	H3		
130935-242-01-12	42,4 x 2,0	405	160	45	1		

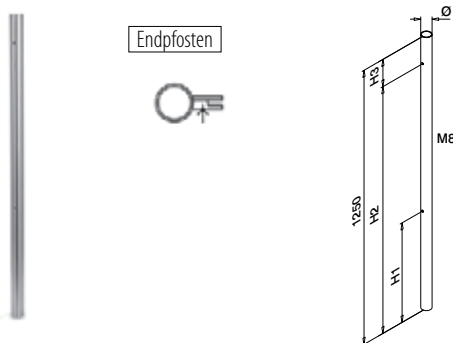
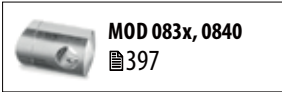

MOD 0937

V2A	304	Gebürstet					
	INDOOR	Ø	H1	H2	H3		
130937-242-01-12	42,4 x 2,0	455	1130	120	1		

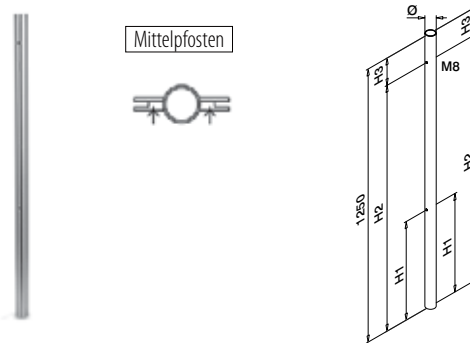

MOD 0937

V2A	304	Gebürstet					
	INDOOR	Ø	H1	H2	H3		
130937-242-02-12	42,4 x 2,0	455	1130	120	1		

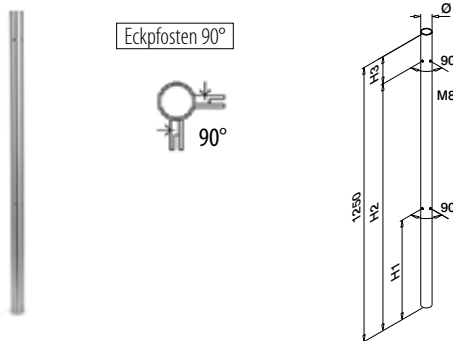

MOD 0937

V2A	304	Gebürstet					
	INDOOR	Ø	H1	H2	H3		
130937-242-90-12	42,4 x 2,0	455	1130	120	1		

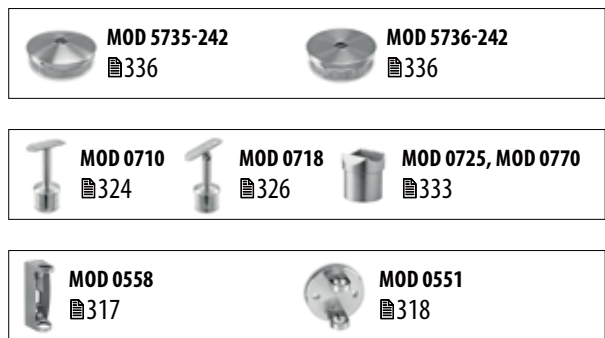
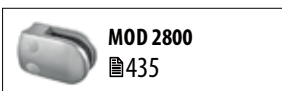

Q-INFO

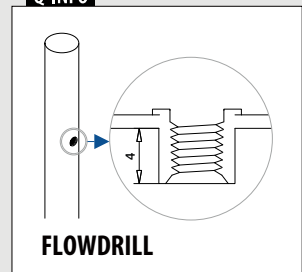

Geländerpfosten

Geländerpfosten

Für Treppen

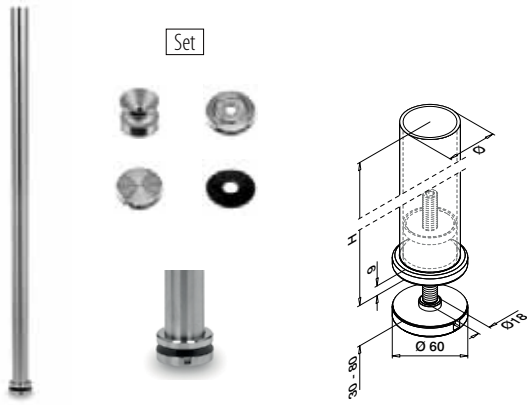

MOD 0545

V2A	304	Gebürstet		
	INDOOR	Ø	H	
130545		42,4 x 2,0	1150	1



Geländerpfosten

Treppenflansche

Für Aufsteckrohre

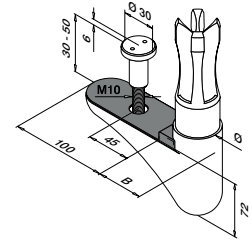

MOD 0947

V2A	304	Gebürstet		
	INDOOR	Ø	B	
130947-242		42,4 x 2,0	48	1



Internationaler Geschmacksmusterschutz



MOD 0947

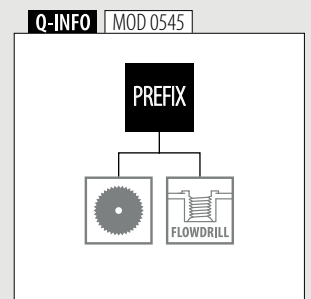
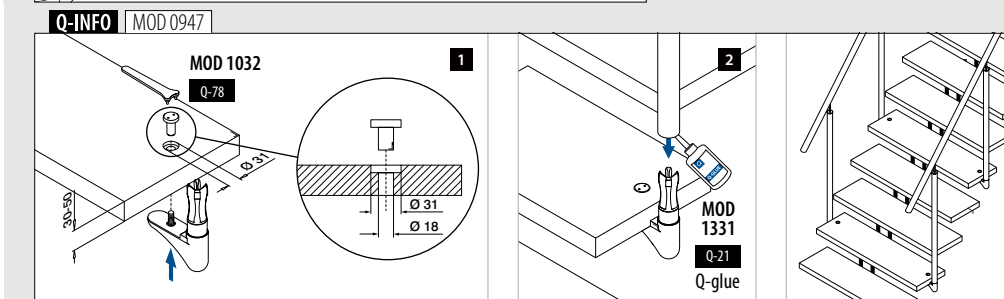
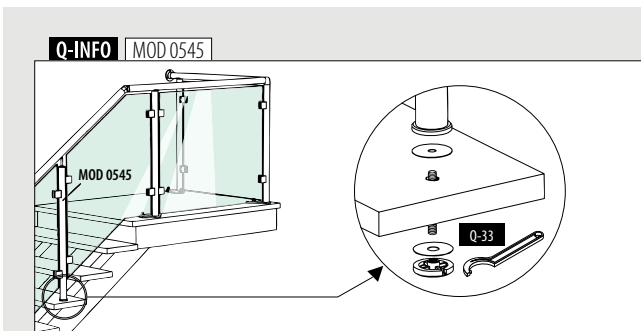

## Innenkern

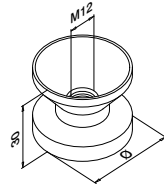

## MOD 3501

V2A	304	Roh		
<b>INDOOR</b>				
	<b>Ø</b>			
133501-242	42,4 x 2,0	QS-274	466	2
SELL OUT	133501-042	42,4 x 2,6	QS-274	466



## Unterlegscheibe

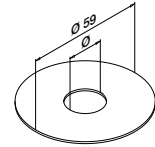

## MOD 5080 / 5081

Zubehör		
	<b>Ø</b>	
205080	18	20
205081	12	20

## Rosette

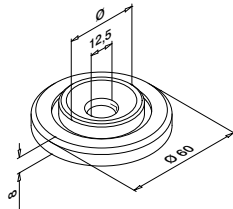

## MOD 0501

V2A	304	Gebürstet		
<b>INDOOR</b>				
	<b>Ø</b>			
130501-042	42,4 x 2,0 + 42,4 x 2,6			2

## Abdeckkappen

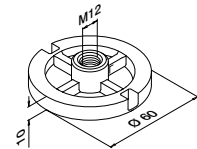

## MOD 0731

V2A	304	Gebürstet		
<b>INDOOR</b>				
130731				2



## Q-INFO | MOD 3501

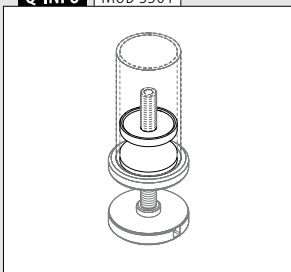

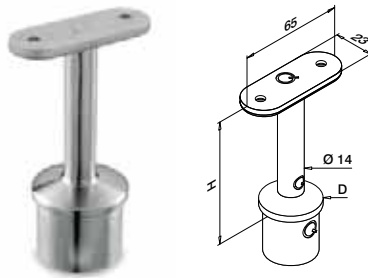
Für rundes Rohr  
zu flachem Rohr

## MOD 0709

V2A	304	Gebürstet	INDOOR	D	H		
130709-000-00-12	33,7 x 2,0	80	QS-12	474	2		

## MOD 0710

V2A	304	Gebürstet	INDOOR	D	H		
130710-000-00-12	42,4 x 2,0	81	QS-12	474	2		

V4A	316	Gebürstet	OUTDOOR	D	H		
140710-000-00-12	42,4 x 2,0	81	QS-13	474	2		

## MOD 0711

V2A	304	Gebürstet	INDOOR	D	H		
130711-000-00-12	48,3 x 2,0	82	QS-12	474	2		

## MOD 0712

V2A	304	Gebürstet	INDOOR	D	H		
130712-000-00-12	42,4 x 2,6	81	QS-12	474	2		

V4A	316	Gebürstet	OUTDOOR	D	H		
140712-000-00-12	42,4 x 2,6	81	QS-13	474	2		

## MOD 0713

V4A	316	Gebürstet	OUTDOOR	D	H		
140713-000-00-12	48,3 x 2,6	82	QS-13	474	2		



Für rundes Rohr

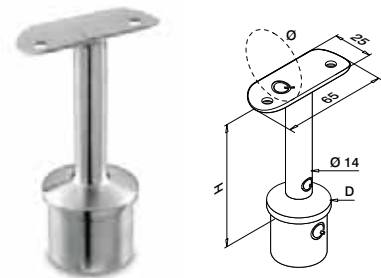

## MOD 0709

V2A	304	Gebürstet	INDOOR	D	Ø	H		
130709-033-00-12	33,7 x 2,0	33,7	78	QS-10	474	2		
130709-042-00-12	33,7 x 2,0	42,4	78	QS-10	474	2		

## MOD 0710

V2A	304	Gebürstet	INDOOR	D	Ø	H		
130710-042-00-12	42,4 x 2,0	42,4	79	QS-10	474	2		
130710-048-00-12	42,4 x 2,0	48,3	79	QS-10	474	2		

V4A	316	Gebürstet	OUTDOOR	D	Ø	H		
140710-042-00-12	42,4 x 2,0	42,4	79	QS-11	474	2		

V4A	316	Hochglanzpoliert	OUTDOOR	D	Ø	H		
140710-042-00-10	42,4 x 2,0	42,4	79	QS-11	474	2		

## MOD 0711

V2A	304	Gebürstet	INDOOR	D	Ø	H		
130711-048-00-12	48,3 x 2,0	48,3	80	QS-10	474	2		

V4A	316	Gebürstet	OUTDOOR	D	Ø	H		
140711-048-00-12	48,3 x 2,0	48,3	80	QS-11	474	2		

## MOD 0712

V2A	304	Gebürstet	INDOOR	D	Ø	H		
130712-042-00-12	42,4 x 2,6	42,4	79	QS-10	474	2		
130712-048-00-12	42,4 x 2,6	48,3	79	QS-10	474	2		

V4A	316	Gebürstet	OUTDOOR	D	Ø	H		
140712-042-00-12	42,4 x 2,6	42,4	79	QS-11	474	2		

## MOD 0713

V2A	304	Gebürstet	INDOOR	D	Ø	H		
130713-042-00-12	48,3 x 2,6	42,4	80	QS-10	474	2		
130713-048-00-12	48,3 x 2,6	48,3	80	QS-10	474	2		

V4A	316	Gebürstet	OUTDOOR	D	Ø	H		
140713-042-00-12	48,3 x 2,6	42,4	80	QS-11	474	2		
140713-048-00-12	48,3 x 2,6	48,3	80	QS-11	474	2		

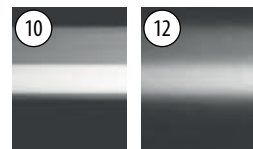

## Q-INFO 316

Hochglanz-  
poliert

Gebürstet

## Q-INFO

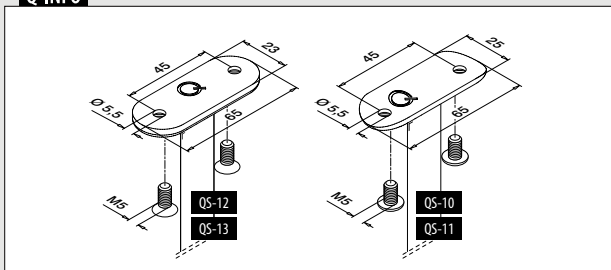

SELL OUT Nur solange der Vorrat reicht.



Für rundes Rohr

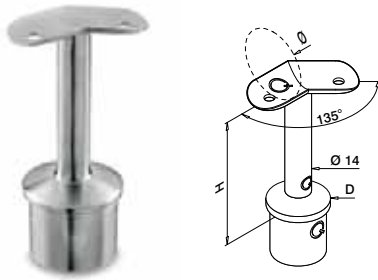

**MOD 0710**

V2A	304	Gebürstet						
<b>INDOOR</b>			<b>D</b>	<b>Ø</b>	<b>H</b>			
130710-042-45-12	42,4 x 2,0	42,4	79	QS-10	474	2		

V4A	316	Gebürstet						
<b>OUTDOOR</b>			<b>D</b>	<b>Ø</b>	<b>H</b>			
140710-042-45-12	42,4 x 2,0	42,4	79	QS-11	474	2		

**MOD 0711**

V4A	316	Gebürstet						
<b>OUTDOOR</b>			<b>D</b>	<b>Ø</b>	<b>H</b>			
140711-048-45-12	48,3 x 2,0	48,3	80	QS-11	474	2		

**MOD 0712**

V2A	304	Gebürstet						
<b>INDOOR</b>			<b>D</b>	<b>Ø</b>	<b>H</b>			
SELL OUT 130712-042-45-12	42,4 x 2,6	42,4	79	QS-10	474	2		

V4A	316	Gebürstet						
<b>OUTDOOR</b>			<b>D</b>	<b>Ø</b>	<b>H</b>			
SELL OUT 140712-042-45-12	42,4 x 2,6	42,4	79	QS-11	474	2		

**MOD 0713**

V4A	316	Gebürstet						
<b>OUTDOOR</b>			<b>D</b>	<b>Ø</b>	<b>H</b>			
140713-048-45-12	48,3 x 2,6	48,3	80	QS-11	474	2		

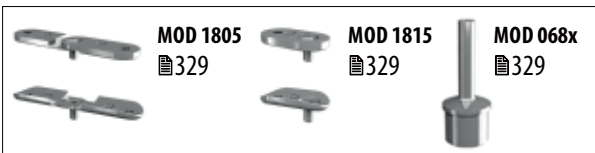

Für rundes Rohr

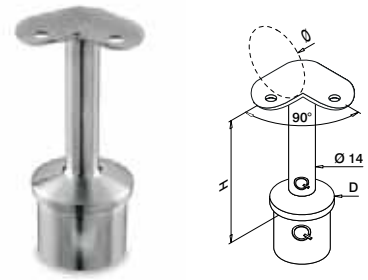

**MOD 0709**

V2A	304	Gebürstet						
<b>INDOOR</b>			<b>D</b>	<b>Ø</b>	<b>H</b>			
SELL OUT 130709-033-90-12	33,7 x 2,0	33,7	78	QS-10	474	2		
SELL OUT 130709-042-90-12	33,7 x 2,0	42,4	78	QS-10	474	2		

**MOD 0710**

V2A	304	Gebürstet						
<b>INDOOR</b>			<b>D</b>	<b>Ø</b>	<b>H</b>			
130710-042-90-12	42,4 x 2,0	42,4	79	QS-10	474	2		
130710-048-90-12	42,4 x 2,0	48,3	79	QS-10	474	2		

V4A	316	Gebürstet						
<b>OUTDOOR</b>			<b>D</b>	<b>Ø</b>	<b>H</b>			
140710-042-90-12	42,4 x 2,0	42,4	79	QS-11	474	2		

V4A	316	Hochglanzpoliert						
<b>OUTDOOR</b>			<b>D</b>	<b>Ø</b>	<b>H</b>			
140710-042-90-10	42,4 x 2,0	42,4	79	QS-11	474	2		

**MOD 0711**

V2A	304	Gebürstet						
<b>INDOOR</b>			<b>D</b>	<b>Ø</b>	<b>H</b>			
130711-048-90-12	48,3 x 2,0	48,3	80	QS-10	474	2		

V4A	316	Gebürstet						
<b>OUTDOOR</b>			<b>D</b>	<b>Ø</b>	<b>H</b>			
140711-048-90-12	48,3 x 2,0	48,3	80	QS-11	474	2		

**MOD 0712**

V2A	304	Gebürstet						
<b>INDOOR</b>			<b>D</b>	<b>Ø</b>	<b>H</b>			
SELL OUT 130712-042-90-12	42,4 x 2,6	42,4	79	QS-10	474	2		

V4A	316	Gebürstet						
<b>OUTDOOR</b>			<b>D</b>	<b>Ø</b>	<b>H</b>			
SELL OUT 140712-042-90-12	42,4 x 2,6	42,4	79	QS-11	474	2		

**MOD 0713**

V2A	304	Gebürstet						
<b>INDOOR</b>			<b>D</b>	<b>Ø</b>	<b>H</b>			
130713-042-90-12	48,3 x 2,6	42,4	80	QS-10	474	2		
130713-048-90-12	48,3 x 2,6	48,3	80	QS-10	474	2		

V4A	316	Gebürstet						
<b>OUTDOOR</b>			<b>D</b>	<b>Ø</b>	<b>H</b>			
140713-048-90-12	48,3 x 2,6	48,3	80	QS-11	474	2		



**Q-INFO** | MOD 071x-04x-45

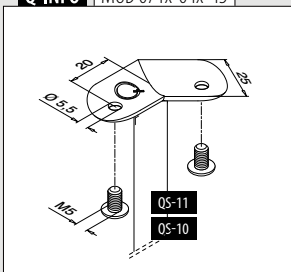

**Q-INFO** | MOD 071x-04x-45

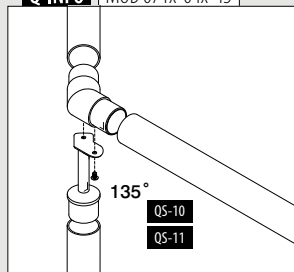

**Q-INFO** | MOD 07xx-04x-90

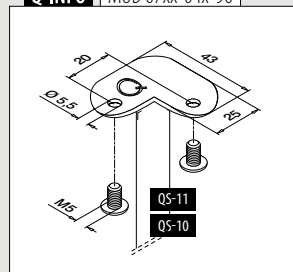

**Q-INFO** | MOD 07xx-04x-90

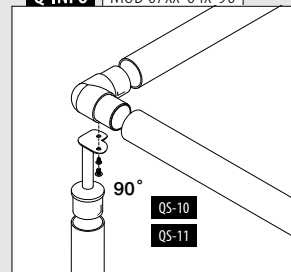

Für rundes Rohr zu flachem Rohr

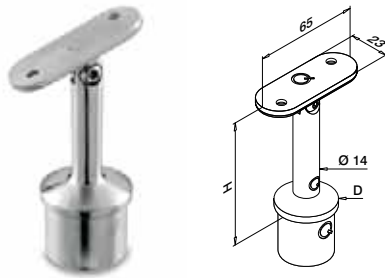

**MOD 0717**

V2A	304	Gebürstet				
INDOOR		D	H			
SELL OUT	130717-000-12	33,7 x 2,0	80	QS-12	474	2

**MOD 0718**

V2A	304	Gebürstet				
INDOOR		D	H			
	130718-000-12	42,4 x 2,0	81	QS-12	474	2

**MOD 0720**

V2A	304	Gebürstet				
INDOOR		D	H			
SELL OUT	130720-000-12	42,4 x 2,6	81	QS-12	474	2



Für rundes Rohr

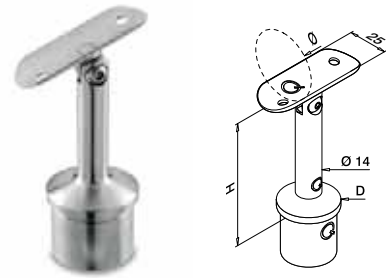

**MOD 0717**

V2A	304	Gebürstet					
INDOOR		D	Ø	H			
	130717-033-12	33,7 x 2,0	33,7	78	QS-10	474	2
	130717-042-12	33,7 x 2,0	42,4	78	QS-10	474	2

**MOD 0718**

V2A	304	Gebürstet					
INDOOR		D	Ø	H			
	130718-042-12	42,4 x 2,0	42,4	79	QS-10	474	2
	130718-048-12	42,4 x 2,0	48,3	79	QS-10	474	2

**MOD 0719**

V4A	316	Gebürstet					
OUTDOOR		D	Ø	H			
	140718-042-12	42,4 x 2,0	42,4	79	QS-11	474	2
	140718-048-12	42,4 x 2,0	48,3	79	QS-11	474	2

**MOD 0720**

V4A	316	Hochglanzpoliert					
OUTDOOR		D	Ø	H			
	140718-042-10	42,4 x 2,0	42,4	79	QS-11	474	2

**MOD 0719**

V2A	304	Gebürstet					
INDOOR		D	Ø	H			
	130719-048-12	48,3 x 2,0	48,3	80	QS-10	474	2

**MOD 0720**

V4A	316	Gebürstet					
OUTDOOR		D	Ø	H			
	140719-048-12	48,3 x 2,0	48,3	80	QS-11	474	2

**MOD 0720**

V2A	304	Gebürstet					
INDOOR		D	Ø	H			
SELL OUT	130720-042-12	42,4 x 2,6	42,4	79	QS-10	474	2
SELL OUT	130720-048-12	42,4 x 2,6	48,3	79	QS-10	474	2

**MOD 0721**

V4A	316	Gebürstet					
OUTDOOR		D	Ø	H			
SELL OUT	140720-042-12	42,4 x 2,6	42,4	79	QS-11	474	2

**MOD 0721**

V2A	304	Gebürstet					
INDOOR		D	Ø	H			
	130721-042-12	48,3 x 2,6	42,4	80	QS-10	474	2
	130721-048-12	48,3 x 2,6	48,3	80	QS-10	474	2

**MOD 0722**

V4A	316	Gebürstet					
OUTDOOR		D	Ø	H			
	140721-042-12	48,3 x 2,6	42,4	80	QS-11	474	2
	140721-048-12	48,3 x 2,6	48,3	80	QS-11	474	2



**Q-INFO** 304 316

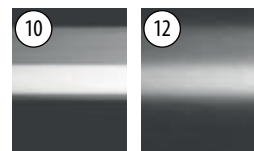

Hochglanzpoliert Gebürstet

**Q-INFO**

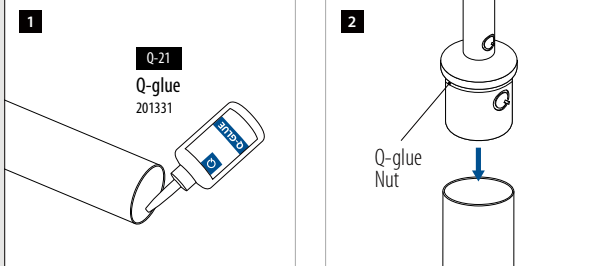

**Q-INFO**

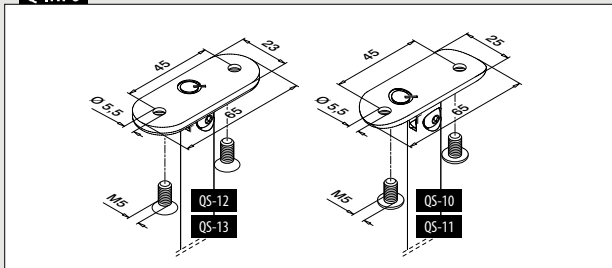

SELL OUT Nur solange der Vorrat reicht.



Für rundes Rohr

Einstellbare Höhe

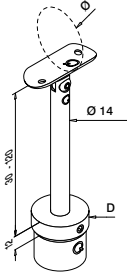

## MOD 0697

V2A	304	Gebürstet				
INDOOR			D	Ø		
130697-042	42,4 x 2,0	42,4	QS-10	474	2	
V4A	316	Gebürstet				
OUTDOOR			D	Ø		
140697-042	42,4 x 2,0	42,4	QS-11	474	2	

## MOD 0699

V2A	304	Gebürstet				
INDOOR			D	Ø		
130699-048	48,3 x 2,0	48,3	QS-10	474	2	
V4A	316	Gebürstet				
OUTDOOR			D	Ø		
140699-048	48,3 x 2,0	48,3	QS-11	474	2	



Für rundes Rohr

Einstellbare Höhe

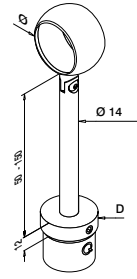

## MOD 0714

V2A	304	Gebürstet				
INDOOR			D	Ø		
SELL OUT 130714-042	42,4 x 2,6	42,4			2	
SELL OUT 130714-048	48,3 x 2,6	48,3			2	

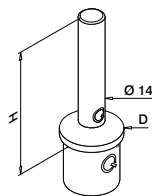

## MOD 0695

V2A	304	Gebürstet				
INDOOR			D	H		
130695	42,4 x 2,0	79			2	
V4A	316	Gebürstet				
OUTDOOR			D	H		
140695	42,4 x 2,0	79			2	

## MOD 0696

V4A	316	Gebürstet				
OUTDOOR			D	H		
140696	48,3 x 2,0	80			2	



## Q-INFO | MOD 0714

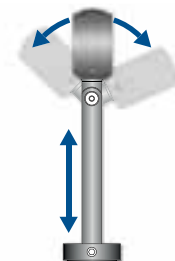

## Q-INFO | MOD 0697 / 0699

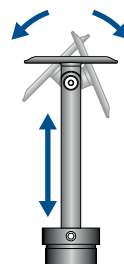

## Q-INFO | MOD 0697 / 0699

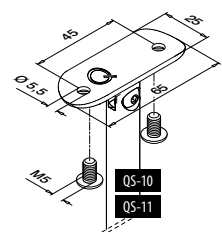





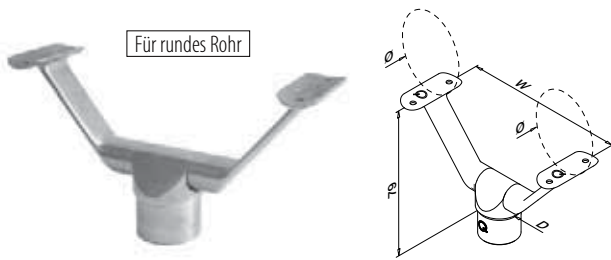

## MOD 0693

V4A	316	Gebürstet				
OUTDOOR			D	Ø	W	
140693-042-12	42,4 x 2,0	42,4	170	QS-11	474	2

## MOD 0694

V4A	316	Gebürstet				
OUTDOOR			D	Ø	W	
140694-048-12	48,3 x 2,0	48,3	194	QS-11	474	2



Internationaler Geschmacksmusterschutz

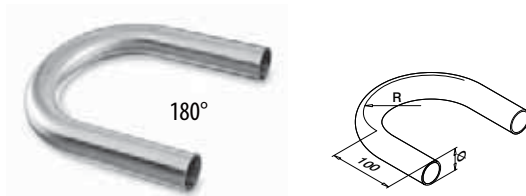

## MOD 0906

V2A	304	Gebürstet			
INDOOR		Ø	R		
130906-242-12	42,4 x 2,0	85	1		
130906-248-12	48,3 x 2,0	97	1		

V4A	316	Gebürstet			
OUTDOOR		Ø	R		
140906-242-12	42,4 x 2,0	85	1		
140906-248-12	48,3 x 2,0	97	1		

## Q-INFO MOD 0693 / 0694

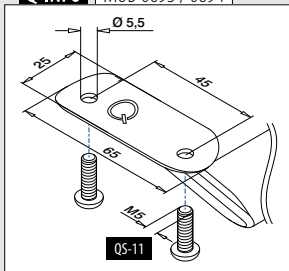

## Q-INFO MOD 0693 / 0694 / 0906

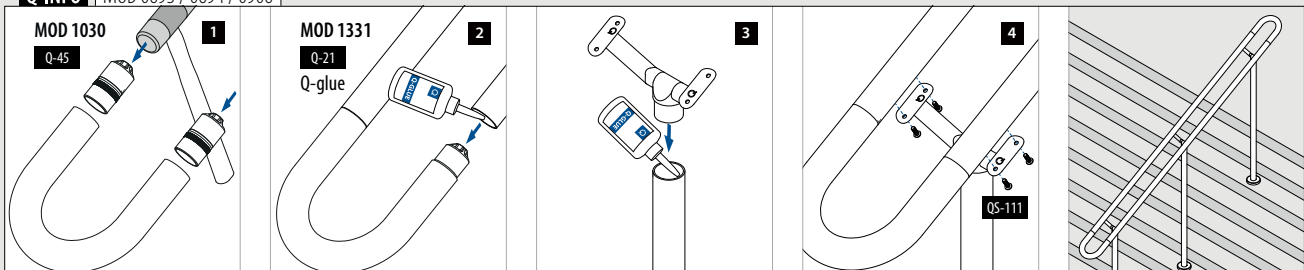

Für rundes Rohr

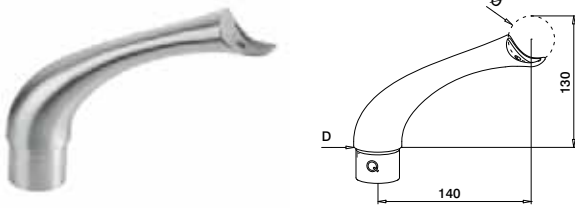

**MOD 0706**

V2A	304	Gebürstet				
INDOOR		D	Ø			
130706	42,4 x 2,0	42,4	QS-83	474	2	

  

V4A	316	Gebürstet				
OUTDOOR		D	Ø			
140706	42,4 x 2,0	42,4	QS-84	474	2	



Internationaler Geschmacksmusterschutz

Für rundes Rohr

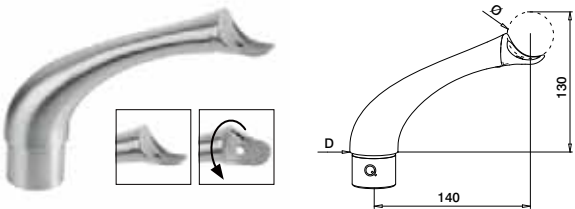

**MOD 0704**

V4A	316	Gebürstet				
OUTDOOR		D	Ø			
140704	42,4 x 2,0	42,4	QS-84	474	2	



Internationaler Geschmacksmusterschutz

Für rundes Rohr

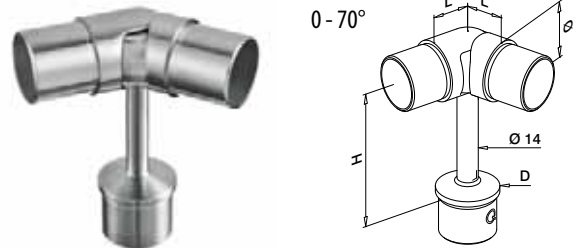

**MOD 0736**

V2A	304	Gebürstet				
INDOOR		D	Ø	H	L	
130736-242	42,4 x 2,0	42,4 x 2,0	100	27	2	

V4A	316	Gebürstet				
OUTDOOR		D	Ø	H	L	
140736-242	42,4 x 2,0	42,4 x 2,0	100	27	2	

**MOD 0737**

V4A	316	Gebürstet				
OUTDOOR		D	Ø	H	L	
140737-248	48,3 x 2,0	48,3 x 2,0	100	30	2	



**Q-INFO** MOD 0704

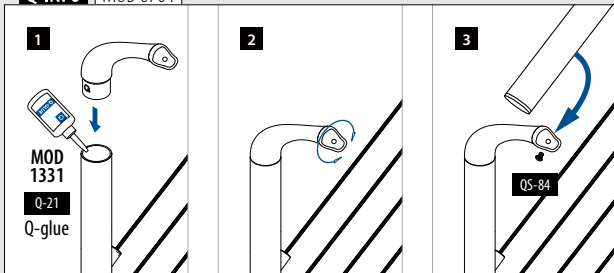

**Q-INFO** MOD 0706

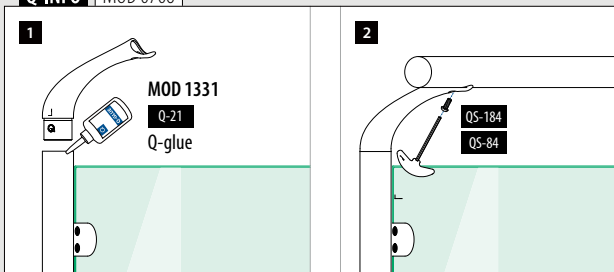

**Q-INFO**

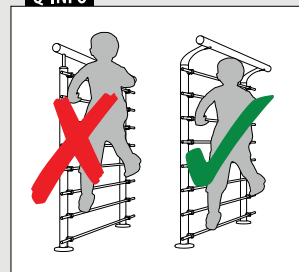

für rundes Rohr zu flachem Rohr

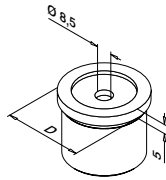

## MOD 0730

V2A	304	Gebürstet		
<b>INDOOR</b>		<b>D</b>		
130730-000	33,7 x 2,0	QS-26	474	2

## MOD 0725

V2A	304	Gebürstet		
<b>INDOOR</b>		<b>D</b>		
130725-000	42,4 x 2,0	QS-26	474	2

V4A	316	Gebürstet		
<b>OUTDOOR</b>				
140725-000	42,4 x 2,0	QS-27	474	2

## MOD 0727

V2A	304	Gebürstet		
<b>INDOOR</b>		<b>D</b>		
SELL OUT 130727-000	42,4 x 2,6	QS-26	474	2

V4A	316	Gebürstet		
<b>OUTDOOR</b>				
SELL OUT 140727-000	42,4 x 2,6	QS-27	474	2

## MOD 0726

V2A	304	Gebürstet		
<b>INDOOR</b>		<b>D</b>		
130726-000	48,3 x 2,0	QS-26	474	2

## MOD 0728

V2A	304	Gebürstet		
<b>INDOOR</b>		<b>D</b>		
SELL OUT 130728-000	48,3 x 2,6	QS-26	474	2



Für rundes Rohr



0-70°

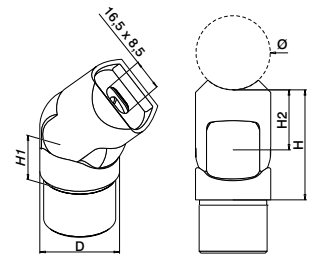

## MOD 0776

V2A	304	Gebürstet						
<b>INDOOR</b>		<b>D</b>	<b>Ø</b>	<b>H1</b>	<b>H2</b>	<b>H</b>		
130776-042-12	42,4 x 2,0	42,4	27	35	62	QS-26	474	2

V4A	316	Gebürstet						
<b>OUTDOOR</b>								
140776-042-12	42,4 x 2,0	42,4	27	35	62	QS-27	474	2

## MOD 0777

V2A	304	Gebürstet						
<b>INDOOR</b>		<b>D</b>	<b>Ø</b>	<b>H1</b>	<b>H2</b>	<b>H</b>		
130777-048-12	48,3 x 2,0	48,3	30	38	68	QS-26	474	2

V4A	316	Gebürstet						
<b>OUTDOOR</b>								
140777-048-12	48,3 x 2,0	48,3	30	38	68	QS-27	474	2



Internationaler Geschmacksmusterschutz

SELL OUT Nur solange der Vorrat reicht.

## Q-INFO | MOD 0730 / 072x

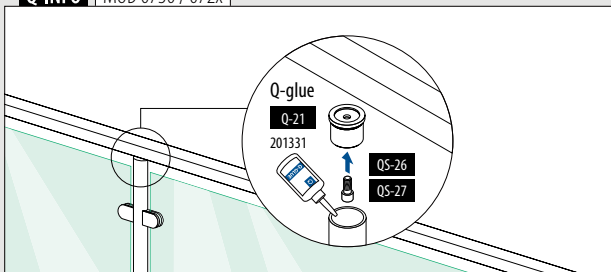

## Q-INFO | MOD 0776 / 0777

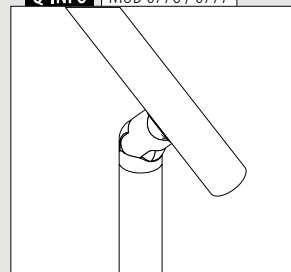

Für rundes Rohr

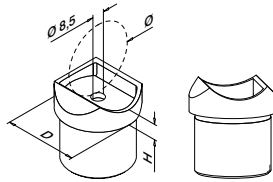
**MOD 0774**

V2A	304	Gebürstet				
INDOOR			D	Ø	H	
130774-12	33,7 x 2,0	33,7	8	QS-26	474	2

Kombinierbar mit MOD 0303 Verbinder.

Für rundes Rohr

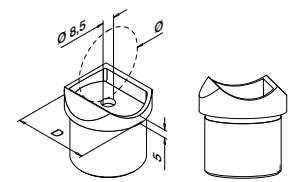
**MOD 0730**

V2A	304	Gebürstet				
INDOOR			D	Ø	H	
130730-042	33,7 x 2,0	42,4	QS-26	474	2	

**MOD 0725**

V2A	304	Gebürstet				
INDOOR			D	Ø	H	
130725-048	42,4 x 2,0	48,3	QS-26	474	2	

V4A	316	Gebürstet				
OUTDOOR			D	Ø	H	
140725-048	42,4 x 2,0	48,3	QS-27	474	2	



Nicht kombinierbar mit MOD 0303 Verbinder.

Für rundes Rohr

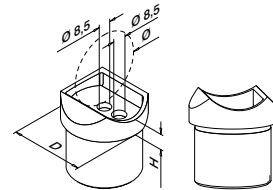
**MOD 0770**

V2A	304	Gebürstet				
INDOOR			D	Ø	H	
130770-042-12	42,4 x 2,0	42,4	9	QS-26	474	2

V4A	316	Gebürstet				
OUTDOOR			D	Ø	H	
140770-042-12	42,4 x 2,0	42,4	9	QS-27	474	2

V4A	316	Hochglanzpoliert				
OUTDOOR			D	Ø	H	
140770-042-10	42,4 x 2,0	42,4	9	QS-27	474	2

**MOD 0772**

V2A	304	Gebürstet				
INDOOR			D	Ø	H	
SELL OUT 130772-042-12	42,4 x 2,6	42,4	9	QS-26	474	2

V4A	316	Gebürstet				
OUTDOOR			D	Ø	H	
SELL OUT 140772-042-12	42,4 x 2,6	42,4	9	QS-27	474	2

**MOD 0771**

V2A	304	Gebürstet				
INDOOR			D	Ø	H	
130771-048-12	48,3 x 2,0	48,3	11	QS-26	474	2

V4A	316	Gebürstet				
OUTDOOR			D	Ø	H	
140771-048-12	48,3 x 2,0	48,3	11	QS-27	474	2

**MOD 0773**

V2A	304	Gebürstet				
INDOOR			D	Ø	H	
130773-048-12	48,3 x 2,6	48,3	11	QS-26	474	2

V4A	316	Gebürstet				
OUTDOOR			D	Ø	H	
140773-048-12	48,3 x 2,6	48,3	11	QS-27	474	2

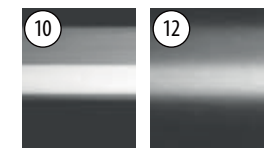

Kombinierbar mit MOD 0303 Verbinder.

**Q-INFO 316**

Hochglanzpoliert Gebürstet

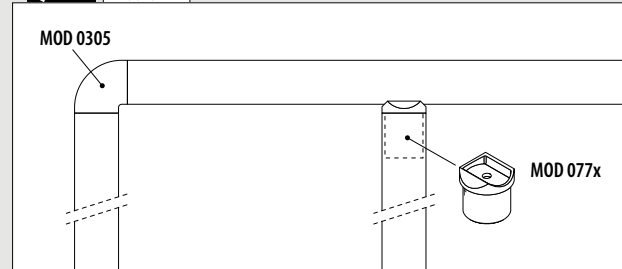
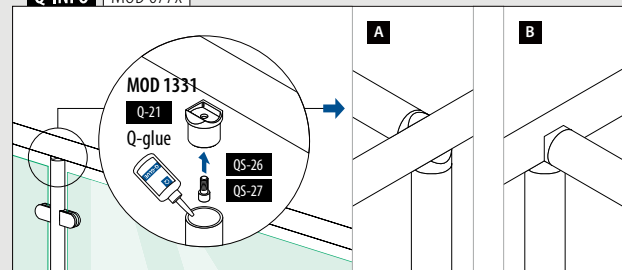
**Q-INFO MOD 077x****Q-INFO MOD 077x**

Für flaches Rohr

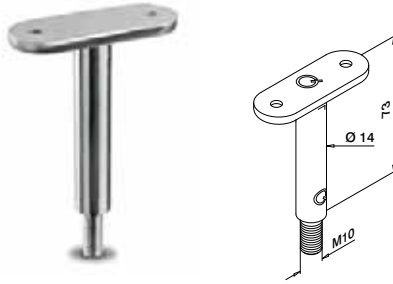

**MOD 0810**

V2A	304	Gebürstet		
<b>INDOOR</b>				
SELL OUT	130810-000-00	QS-12	474	2



Für rundes Rohr

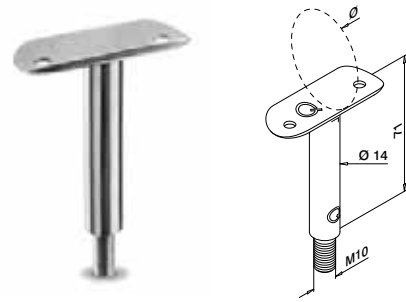

**MOD 0810**

V2A	304	Gebürstet		
<b>INDOOR</b>				
		Ø		
	130810-042-00	42,4	QS-10	474
	130810-048-00	48,3	QS-10	474

V4A	316	Gebürstet		
<b>OUTDOOR</b>				
	140810-042-00	42,4	QS-11	474
	140810-048-00	48,3	QS-11	474



Für flaches Rohr

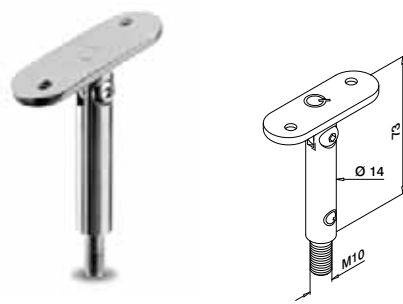

**MOD 0818**

V2A	304	Gebürstet		
<b>INDOOR</b>				
SELL OUT	130818-000	QS-12	474	2



Für rundes Rohr

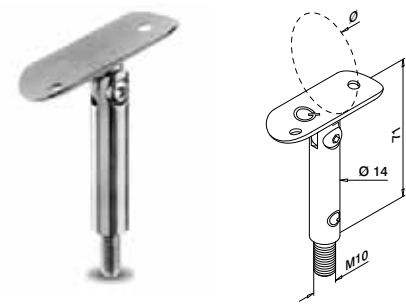

**MOD 0818**

V2A	304	Gebürstet		
<b>INDOOR</b>				
		Ø		
	130818-042	42,4	QS-10	474
	130818-048	48,3	QS-10	474

V4A	316	Gebürstet		
<b>OUTDOOR</b>				
	140818-042	42,4	QS-11	474
	140818-048	48,3	QS-11	474



SELL OUT Nur solange der Vorrat reicht.

**Q-INFO** | MOD 0810

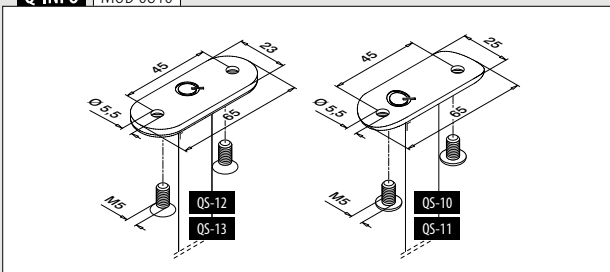

**Q-INFO** | MOD 0818

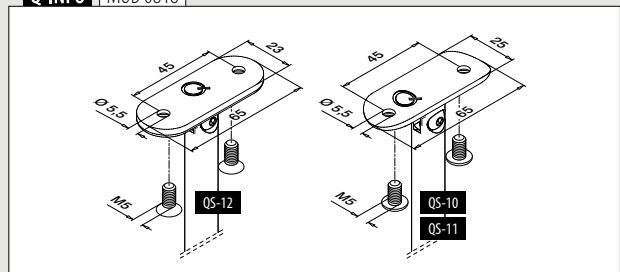



Für rundes Rohr

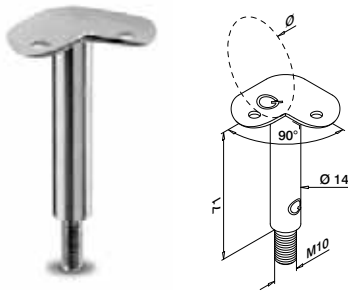

**MOD 0810**

V2A	304	Gebürstet		
<b>INDOOR</b>				
130810-042-90	42,4	QS-10	474	2
130810-048-90	48,3	QS-10	474	2
V4A	316	Gebürstet		
<b>OUTDOOR</b>				
140810-042-90	42,4	QS-11	474	2
140810-048-90	48,3	QS-11	474	2

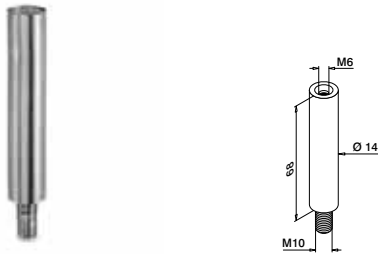

**MOD 0811**

V2A	304	Gebürstet		
<b>INDOOR</b>				
130811		QS-48	474	2
V4A	316	Gebürstet		
<b>OUTDOOR</b>				
140811		QS-89	474	2

**MOD 4811**  
296



**MOD 4733**  
296



**MOD 0812**

V2A	304	Gebürstet		
<b>INDOOR</b>				
130812		QS-48	474	2
V4A	316	Gebürstet		
<b>OUTDOOR</b>				
140812		QS-89	474	2



**Q-INFO** MOD 0810-04x-90

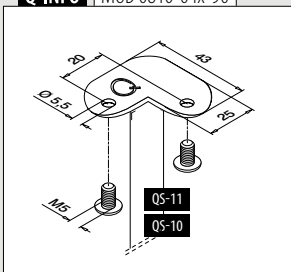

**Q-INFO** MOD 0811 / 0812

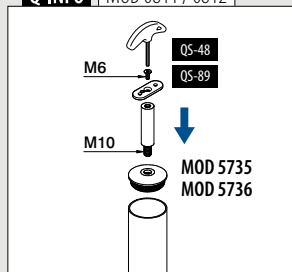

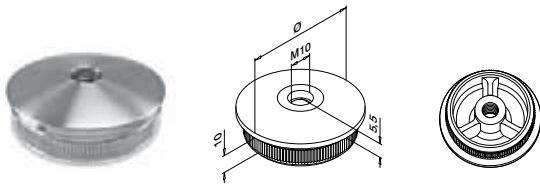

MOD 5735 - EASY HIT®

V2A	304	Gebürstet		
<b>INDOOR</b>				
			Ø	
	135735-242		42,4 x 2,0	2
SELL OUT	135735-042		42,4 x <b>2,6</b>	2
	135735-248		48,3 x 2,0	2
	135735-048		48,3 x <b>2,6</b>	2
V4A	316	Gebürstet		
<b>OUTDOOR</b>				
	145735-242		42,4 x 2,0	2
SELL OUT	145735-042		42,4 x <b>2,6</b>	2
	145735-248		48,3 x 2,0	2
	145735-048		48,3 x <b>2,6</b>	2
SELL OUT	145735-060		60,3 x 2,0	2

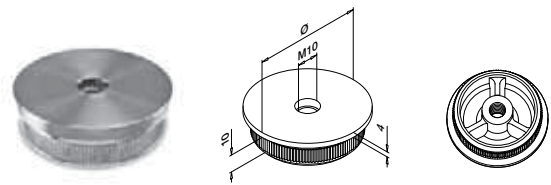

MOD 5736 - EASY HIT®

V2A	304	Gebürstet		
<b>INDOOR</b>				
			Ø	
	135736-242		42,4 x 2,0	2
SELL OUT	135736-042		42,4 x <b>2,6</b>	2
	135736-248		48,3 x 2,0	2
	135736-048		48,3 x <b>2,6</b>	2
V4A	316	Gebürstet		
<b>OUTDOOR</b>				
	145736-242		42,4 x 2,0	2
	145736-248		48,3 x 2,0	2



Für flaches Rohr



MOD 3302

V4A	316	Gebürstet		
<b>OUTDOOR</b>				
	143302-000-12		QS-12 474	2



Für rundes Rohr

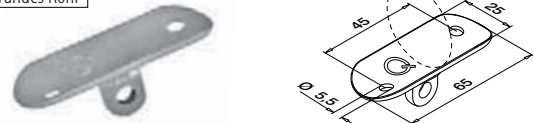

MOD 3302

V4A	316	Gebürstet		
<b>OUTDOOR</b>				
			Ø	
	143302-042-12		42,4	QS-11 474 2
	143302-048-12		48,3	QS-11 474 2



Handlauf-Anschlussplatten

Für flaches Rohr



MOD 1810

V2A	304	Gebürstet		
<b>INDOOR</b>				
131810-000-12	QS-48	474 / QS-10	474	8
V4A	316	Gebürstet		
<b>OUTDOOR</b>				
141810-000-12	QS-89	474 / QS-11	474	8



Für rundes Rohr



MOD 1810

V2A	304	Gebürstet		
<b>INDOOR</b>				
131810-033-12	33,7	QS-48	474 / QS-10	474
131810-042-12	42,4	QS-48	474 / QS-10	474
131810-048-12	48,3	QS-48	474 / QS-10	474
V4A	316	Gebürstet		
<b>OUTDOOR</b>				
141810-042-12	42,4	QS-89	474 / QS-11	474
141810-048-12	48,3	QS-89	474 / QS-11	474



Für flaches Rohr

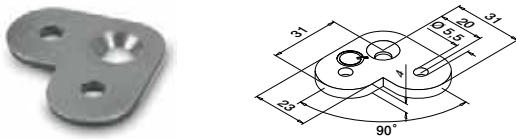

MOD 1802

V2A	304	Gebürstet		
<b>INDOOR</b>				
131802-000	QS-48	474 / QS-10	474	8



Für rundes Rohr

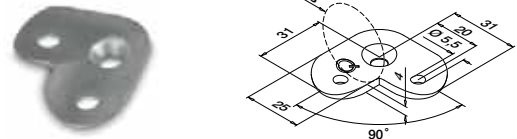

MOD 1802

V2A	304	Gebürstet		
<b>INDOOR</b>				
131802-042	42,4	QS-48	474 / QS-10	474
131802-048	48,3	QS-48	474 / QS-10	474



Für flaches Rohr

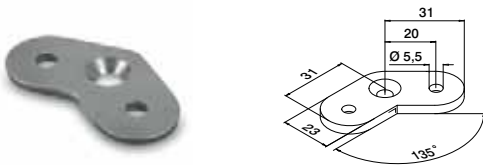

MOD 1801

V2A	304	Gebürstet		
<b>INDOOR</b>				
131801-000	QS-48	474 / QS-10	474	8



Für rundes Rohr

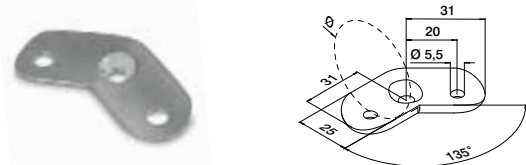

MOD 1801

V2A	304	Gebürstet		
<b>INDOOR</b>				
131801-042	42,4	QS-48	474 / QS-10	474
131801-048	48,3	QS-48	474 / QS-10	474



Für rundes Rohr

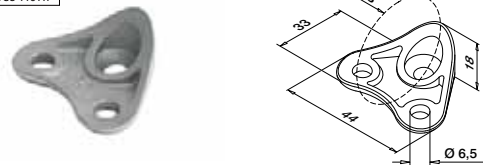

MOD 1820

V4A	316	Gebürstet		
<b>OUTDOOR</b>				
141820-042-12	42,4	QS-89	474 / QS-11	474

Kombinierbar mit MOD 0305 Verbinder.  
Internationaler Geschmacksmusterschutz

Für flaches Rohr

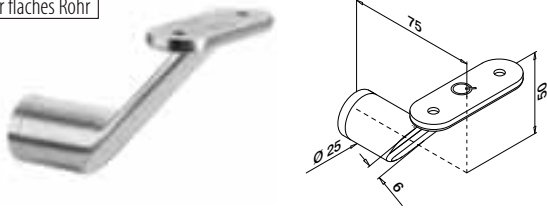

**MOD 0123**

<b>V2A</b>	<b>304</b>	Gebürstet		
<b>INDOOR</b>				
130123-000-12	QS-12	474 / QS-21	474	2
<b>V4A</b>	<b>316</b>	Gebürstet		
<b>OUTDOOR</b>				
140123-000-12	QS-13	474 / QS-22	474	2



Internationaler Geschmacksmusterschutz

Für flaches Rohr zu rundem Rohr

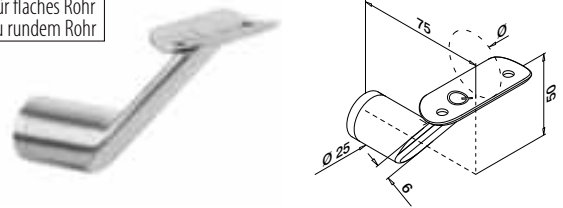

**MOD 0123**

<b>V2A</b>	<b>304</b>	Gebürstet			
<b>INDOOR</b>					
130123-042-12	42,4	QS-10	474 / QS-21	474	2
130123-048-12	48,3	QS-10	474 / QS-21	474	2
<b>V4A</b>	<b>316</b>	Gebürstet			
<b>OUTDOOR</b>					
140123-042-12	42,4	QS-11	474 / QS-22	474	2



Internationaler Geschmacksmusterschutz

Für rundes Rohr

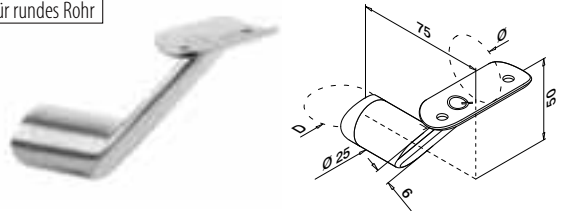

**MOD 0124**

<b>V2A</b>	<b>304</b>	Gebürstet				
<b>INDOOR</b>						
130124-042-12	42,4	D 42,4	QS-10	474 / QS-21	474	2
<b>V4A</b>	<b>316</b>	Gebürstet				
<b>OUTDOOR</b>						
140124-042-12	42,4	D 42,4	QS-11	474 / QS-22	474	2

**MOD 0125**

<b>V2A</b>	<b>304</b>	Gebürstet				
<b>INDOOR</b>						
130125-042-12	48,3	D 42,4	QS-10	474 / QS-21	474	2
130125-048-12	48,3	48,3	QS-10	474 / QS-21	474	2
<b>V4A</b>	<b>316</b>	Gebürstet				
<b>OUTDOOR</b>						
140125-048-12	48,3	48,3	QS-11	474 / QS-22	474	2



Internationaler Geschmacksmusterschutz

**Q-INFO**

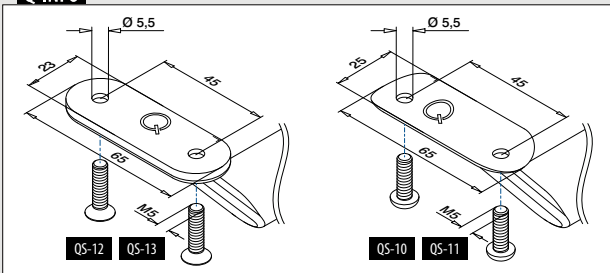

**Q-INFO**

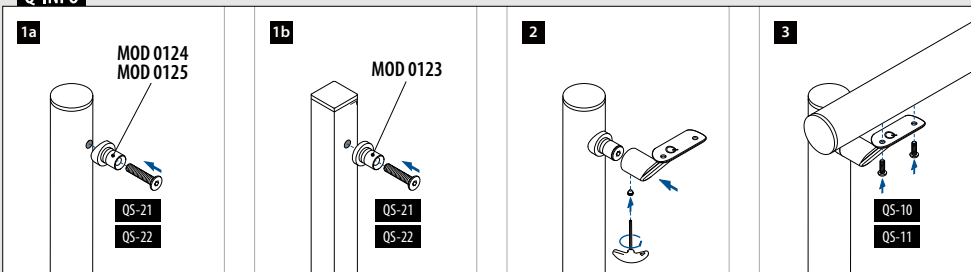

Für flaches Rohr zu rundem Rohr  
Einstellbare Höhe

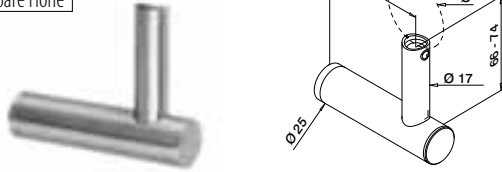

**MOD 0147**

V2A	304	Gebürstet			
<b>INDOOR</b>		Ø			
SELL OUT	130147-044	42,4 / 48,3	QS-21	474 / QS-25	474 2
V4A	316	Gebürstet			
<b>OUTDOOR</b>					
SELL OUT	140147-044	42,4 / 48,3	QS-22	474 / QS-71	474 2



Internationaler Geschmacksmusterschutz

Für rundes Rohr  
Einstellbare Höhe

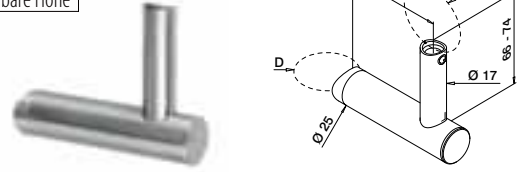

**MOD 0143**

V2A	304	Gebürstet			
<b>INDOOR</b>		D Ø			
SELL OUT	130143-044-12	42,4 42,4 / 48,3	QS-21	474 / QS-25	474 2

**MOD 0144**

V2A	304	Gebürstet			
<b>INDOOR</b>		D Ø			
SELL OUT	130144-044-12	48,3 42,4 / 48,3	QS-21	474 / QS-25	474 2



Internationaler Geschmacksmusterschutz

Für rundes Rohr

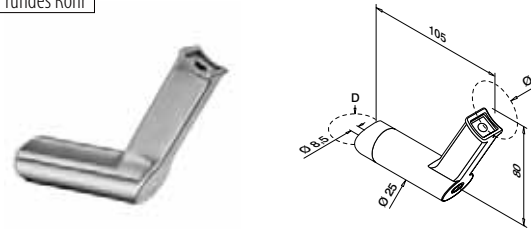

**MOD 9330**

V2A	304	Gebürstet			
<b>INDOOR</b>		D Ø			
SELL OUT	139330-042	42,4 42,4	QS-21	474 / QS-25	474 2



SELL OUT Nur solange der Vorrat reicht.

**Q-INFO** MOD 0147 / 0143 / 0144

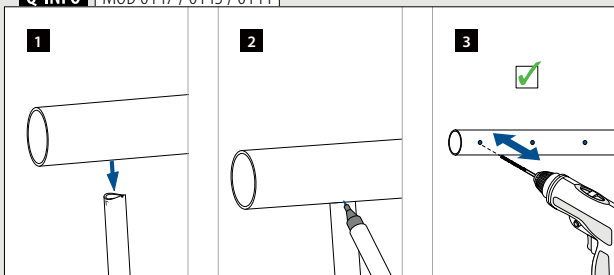

**Q-INFO** MOD 9330

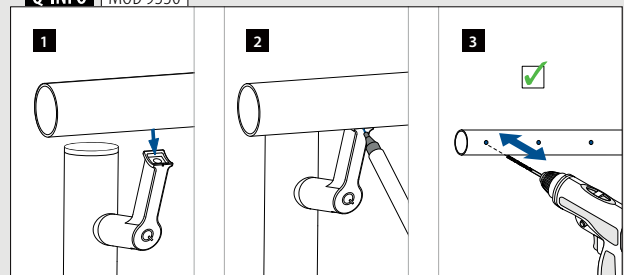

**Q-INFO** MOD 0147 / 0143 / 0144

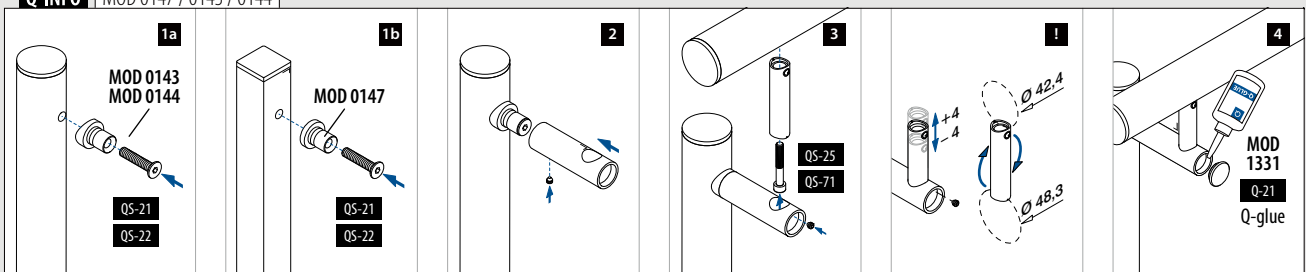



Für flaches Rohr  
Einstellbare Höhe

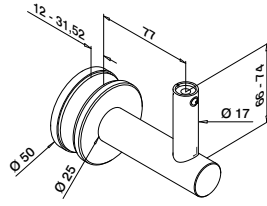

**MOD 0148**

<b>V2A</b>	<b>304</b>	Gebürstet		
<b>INDOOR</b>				
<b>SELL OUT</b>	130148-000-12	QS-24	474	2



Internationaler Geschmacksmusterschutz

Für rundes Rohr  
Einstellbare Höhe

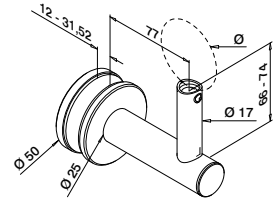

**MOD 0148**

<b>V2A</b>	<b>304</b>	Gebürstet		
<b>INDOOR</b>				
<b>SELL OUT</b>	130148-044-12	42,4 / 48,3	QS-25	474
<b>V4A</b>	<b>316</b>	Gebürstet		
<b>OUTDOOR</b>				
<b>SELL OUT</b>	140148-044-12	42,4 / 48,3	QS-71	474



Internationaler Geschmacksmusterschutz

Für rundes Rohr

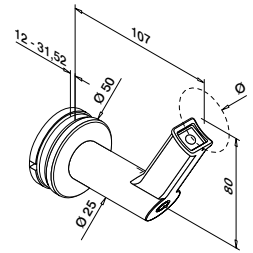

**MOD 9350**

<b>V2A</b>	<b>304</b>	Gebürstet		
<b>INDOOR</b>				
	139350-042	42,4	QS-25	474
	139350-048	48,3	QS-25	474

<b>V4A</b>	<b>316</b>	Gebürstet		
<b>OUTDOOR</b>				
<b>SELL OUT</b>	149350-042	42,4	QS-71	474
<b>SELL OUT</b>	149350-048	48,3	QS-71	474



**SELL OUT** Nur solange der Vorrat reicht.

**Q-INFO** MOD 0148-044

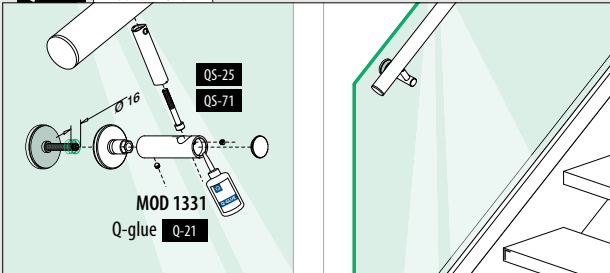

**Q-INFO** MOD 9350

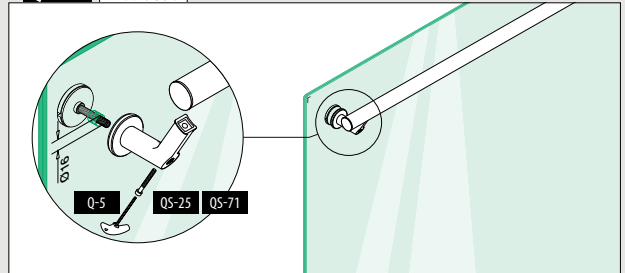

**Q-INFO** MOD 0148-044

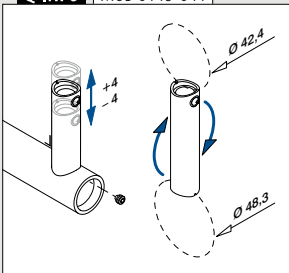

**Q-INFO** MOD 0148-044

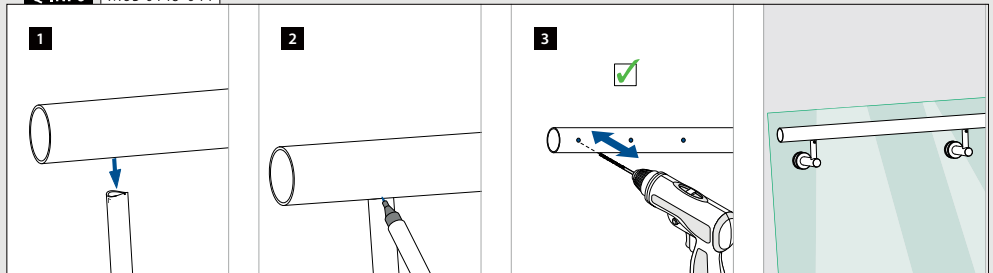

Für flaches Rohr

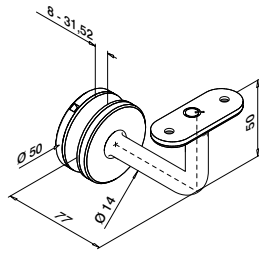

**MOD 0117**

<b>V2A</b>	<b>304</b>	Gebürstet		
<b>INDOOR</b>				
130117-000-12	QS-12	474	2	
<b>V4A</b>	<b>316</b>	Gebürstet		
<b>OUTDOOR</b>				
140117-000-12	QS-13	474	2	



Für rundes Rohr

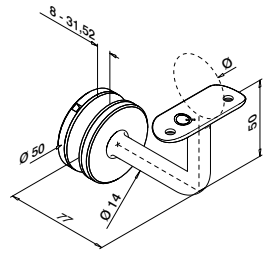

**MOD 0117**

<b>V2A</b>	<b>304</b>	Gebürstet		
<b>INDOOR</b>				
130117-033-12	33,7	QS-10	474	2
130117-042-12	42,4	QS-10	474	2
130117-048-12	48,3	QS-10	474	2
<b>V4A</b>	<b>316</b>	Gebürstet		
<b>OUTDOOR</b>				
140117-042-12	42,4	QS-11	474	2
140117-048-12	48,3	QS-11	474	2
<b>V4A</b>	<b>316</b>	Hochglanzpoliert		
<b>OUTDOOR</b>				
140117-042-10	42,4	QS-11	474	2
140117-048-10	48,3	QS-11	474	2



Für flaches Rohr

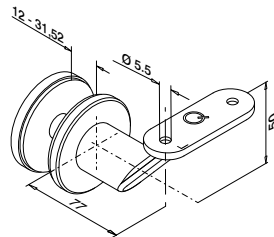

**MOD 0129**

<b>V2A</b>	<b>304</b>	Gebürstet		
<b>INDOOR</b>				
130129-000-12	QS-12	474	2	
<b>V4A</b>	<b>316</b>	Gebürstet		
<b>OUTDOOR</b>				
140129-000-12	QS-13	474	2	



Für rundes Rohr

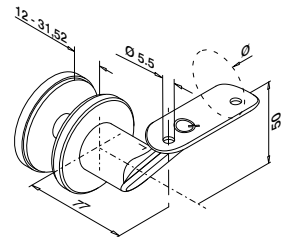

**MOD 0129**

<b>V2A</b>	<b>304</b>	Gebürstet		
<b>INDOOR</b>				
130129-042-12	42,4	QS-10	474	2
130129-048-12	48,3	QS-10	474	2
<b>V4A</b>	<b>316</b>	Gebürstet		
<b>OUTDOOR</b>				
140129-042-12	42,4	QS-11	474	2
140129-048-12	48,3	QS-11	474	2



**Q-INFO** MOD 0117

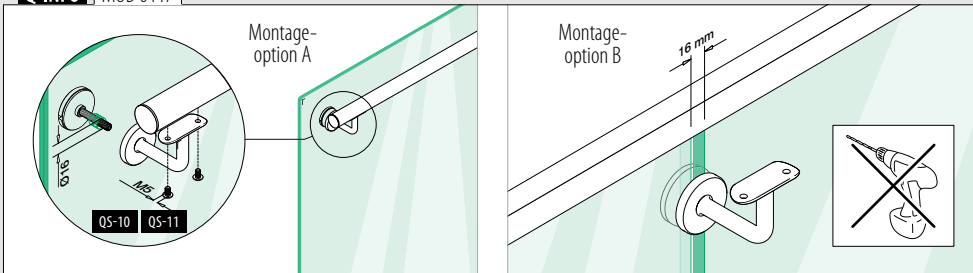

**Q-INFO** 316



**Q-INFO** MOD 0129

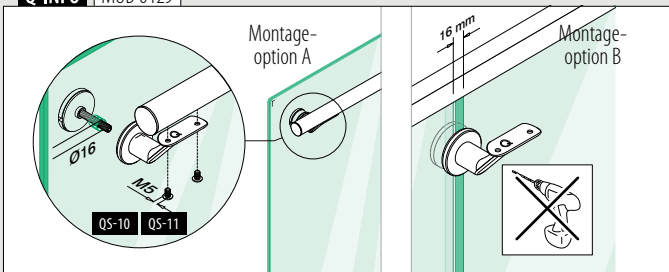

**Q-INFO**

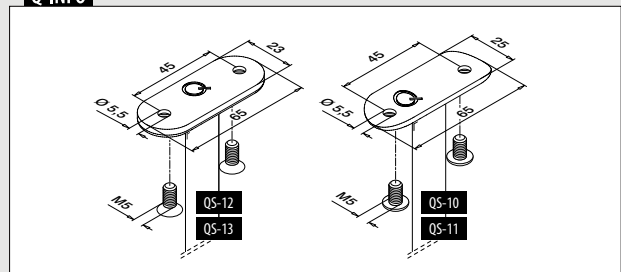

Für flaches Rohr

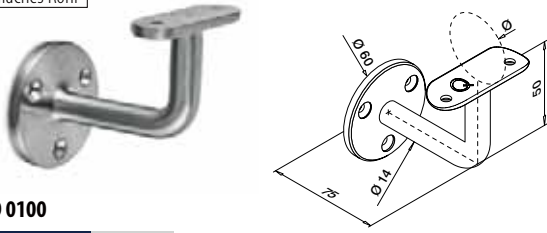

**MOD 0100**

V2A	304	Gebürstet		
<b>INDOOR</b>				
130100-000-12	QS-7	473 / QS-12	474 / QS-87	472
2				
V2A	304	Black Line		
<b>INDOOR</b>				
NEW	130100-000-82	QS-7	473 / QS-12	474 / QS-87
2				
V4A	316	Gebürstet		
<b>OUTDOOR</b>				
140100-000-12	QS-50	473 / QS-13	474 / QS-87	472
2				



Für rundes Rohr

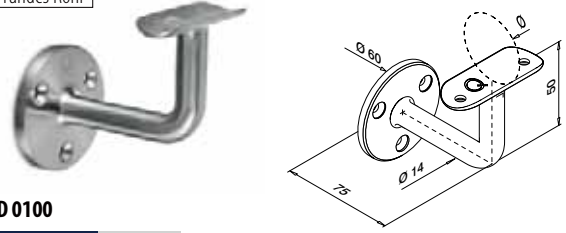

**MOD 0100**

V2A	304	Gebürstet		
<b>INDOOR</b>				
130100-042-12	42,4	QS-7	473 / QS-10	474 / QS-87
2				
130100-048-12	48,3	QS-7	473 / QS-10	474 / QS-87
2				
V4A	316	Gebürstet		
<b>OUTDOOR</b>				
140100-042-12	42,4	QS-50	473 / QS-11	474 / QS-87
2				
140100-048-12	48,3	QS-50	473 / QS-11	474 / QS-87
2				



Für flaches Rohr

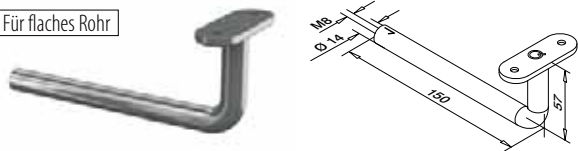

**MOD 0809**

V2A	304	Gebürstet		
<b>INDOOR</b>				
130809-000-12	QS-12	474		2
V4A	316	Gebürstet		
<b>OUTDOOR</b>				
140809-000-12	QS-13	474		2



Für rundes Rohr

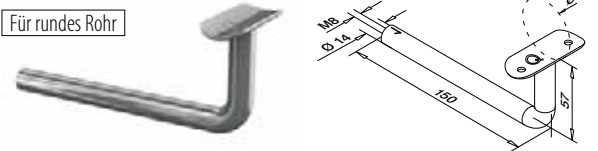

**MOD 0809**

V2A	304	Gebürstet		
<b>INDOOR</b>				
130809-042-12	42,4	QS-10	474	2
130809-048-12	48,3	QS-10	474	2
V4A	316	Gebürstet		
<b>OUTDOOR</b>				
140809-042-12	42,4	QS-11	474	2
140809-048-12	48,3	QS-11	474	2



Flansche für Handlaufstützen MOD 0809



Befestigungsmaterial für MOD 0809 ist enthalten

**MOD 1938**

V2A	304	Gebürstet		
<b>INDOOR</b>				
131938-12	QS-7	473		2
V4A	316	Gebürstet		
<b>OUTDOOR</b>				
141938-12	QS-50	473		2



**MOD 0100**  
Mit Kabelkanal  
260

**Q-INFO** MOD 0100 / 0809

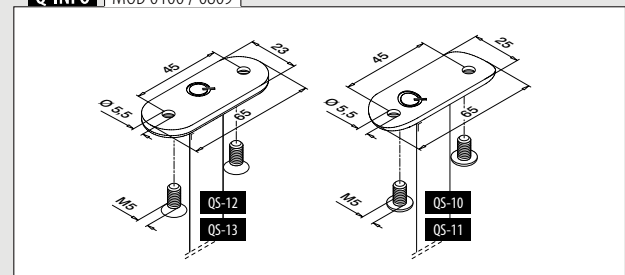

**Q-INFO** MOD 0809 / 1938

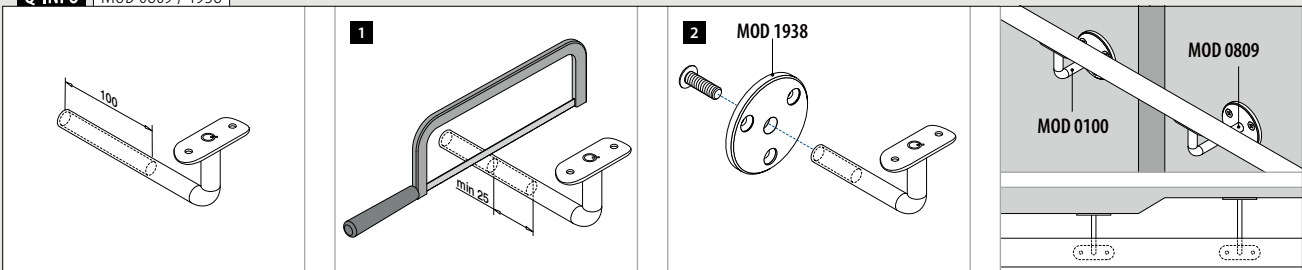

Für flaches Rohr

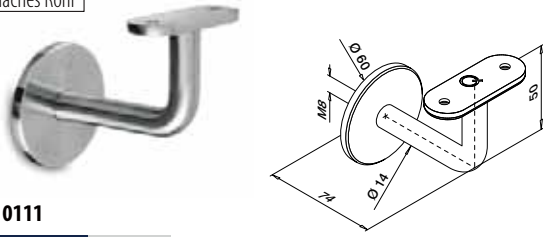

MOD 0111

V2A	304	Gebürstet		
<b>INDOOR</b>				
130111-000-12		QS-12	474	2
V4A	316	Gebürstet		
<b>OUTDOOR</b>				
140111-000-12		QS-13	474	2



Für rundes Rohr

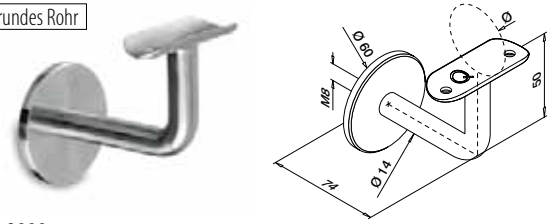

MOD 0111

V2A	304	Gebürstet			
<b>INDOOR</b>					
130111-033-12	33,7	QS-10	474	2	
130111-042-12	42,4	QS-10	474	2	
130111-048-12	48,3	QS-10	474	2	
V2A	304	Hochglanzpoliert			
<b>INDOOR</b>					
SELL OUT	130111-042-10	42,4	QS-10	474	2
V2A	304	Black Line			
<b>INDOOR</b>					
NEW	130111-042-82	42,4	QS-10	474	2
V4A	316	Gebürstet			
<b>OUTDOOR</b>					
140111-042-12	42,4	QS-11	474	2	
140111-048-12	48,3	QS-11	474	2	
V4A	316	Hochglanzpoliert			
<b>OUTDOOR</b>					
140111-042-10	42,4	QS-11	474	2	



SELL OUT Nur solange der Vorrat reicht.

Q-INFO

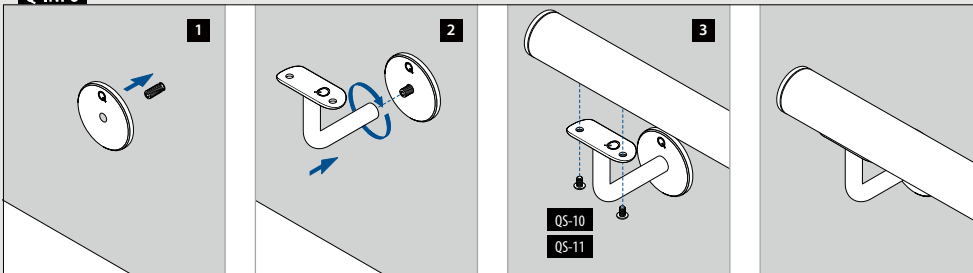

Q-INFO

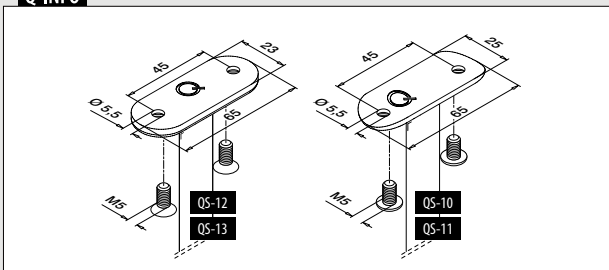

Q-INFO 316 304



Für rundes Rohr

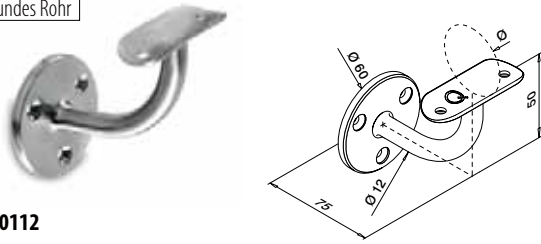

**MOD 0112**

V2A	304	Gebürstet				
<b>INDOOR</b>						
130112-033-12	33,7	QS-7	473 / QS-10	474 / QS-87	472	2
130112-042-12	42,4	QS-7	473 / QS-10	474 / QS-87	472	2
130112-048-12	48,3	QS-7	473 / QS-10	474 / QS-87	472	2
V2A	304	Hochglanzpoliert				
<b>INDOOR</b>						
130112-042-10	42,4	QS-7	473 / QS-10	474 / QS-87	472	2
V4A	316	Gebürstet				
<b>OUTDOOR</b>						
140112-042-12	42,4	QS-50	473 / QS-11	474 / QS-87	472	2
V4A	316	Hochglanzpoliert				
<b>OUTDOOR</b>						
140112-042-10	42,4	QS-50	473 / QS-11	474 / QS-87	472	2
<b>Zinkdruckguss</b> Edelstahleffekt						
<b>INDOOR</b>						
100112-042	42,4	QS-7	473 / QS-10	474 / QS-87	472	2



Für rundes Rohr

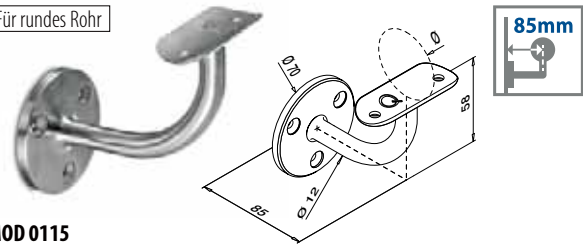

**MOD 0115**

V2A	304	Gebürstet				
<b>INDOOR</b>						
130115	42,4	QS-7	473 / QS-10	474 / QS-87	472	2



Für flaches Rohr

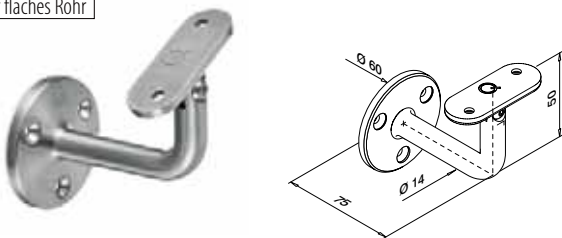

**MOD 0102**

V2A	304	Gebürstet				
<b>INDOOR</b>						
130102-000-12		QS-7	473 / QS-12	474 / QS-87	472	2



Für rundes Rohr

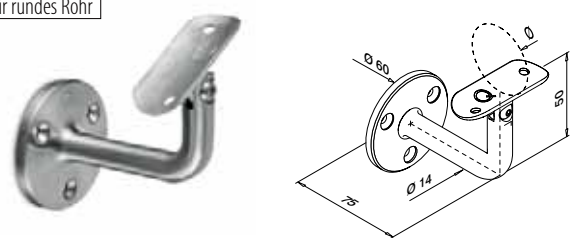

**MOD 0102**

V2A	304	Gebürstet				
<b>INDOOR</b>						
130102-042-12	42,4	QS-7	473 / QS-10	474 / QS-87	472	2
130102-048-12	48,3	QS-7	473 / QS-10	474 / QS-87	472	2

V4A	316	Gebürstet				
<b>OUTDOOR</b>						
140102-042-12	42,4	QS-50	473 / QS-11	474 / QS-87	472	2
140102-048-12	48,3	QS-50	473 / QS-11	474 / QS-87	472	2



**Q-INFO**

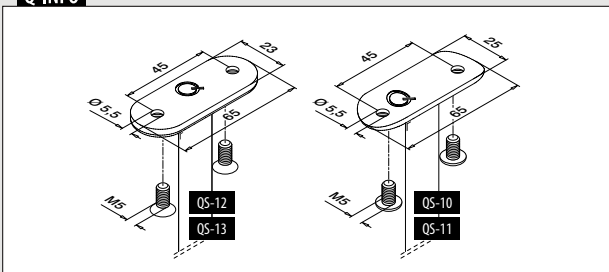

**Q-INFO** 304 316





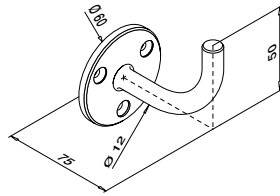

MOD 0113

V2A	304	Gebürstet		
<b>INDOOR</b>				
130113	QS-7	473 / QS-87	472	2

V4A	316	Gebürstet		
<b>OUTDOOR</b>				
140113	QS-50	473 / QS-87	472	2

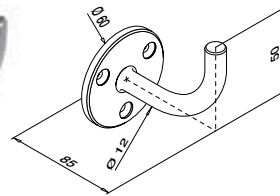

MOD 0109

V2A	304	Gebürstet		
<b>INDOOR</b>				
130109	QS-7	473 / QS-87	472	2

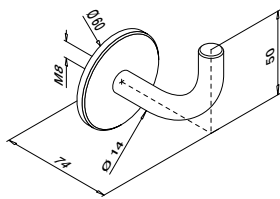

MOD 0114

V2A	304	Gebürstet		
<b>INDOOR</b>				
SELL OUT 130114	QS-1	473		2

V4A	316	Gebürstet		
<b>OUTDOOR</b>				
SELL OUT 140114	QS-2	473		2

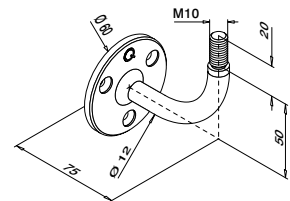

MOD 0118

V2A	304	Gebürstet		
<b>INDOOR</b>				
130118	QS-7	473 / QS-87	472	2

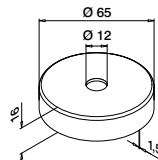

MOD 0519

V4A	316	Gebürstet		
<b>OUTDOOR</b>				
140519				2

<b>Zinkdruckguss</b> Edelstahleffekt				
<b>INDOOR</b>				
SELL OUT 100519				2

SELL OUT Nur solange der Vorrat reicht.

Q-INFO | MOD 0118

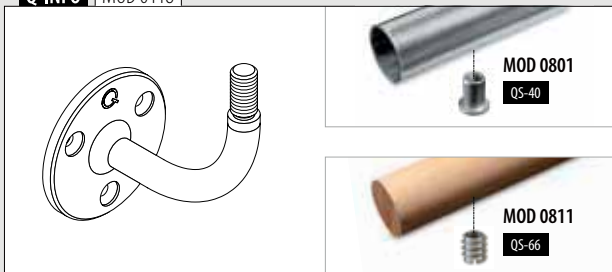

Q-INFO | MOD 0519

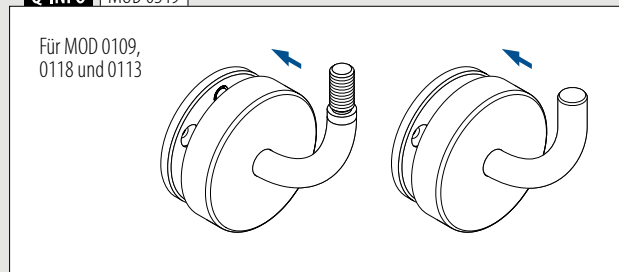

Für flaches Rohr

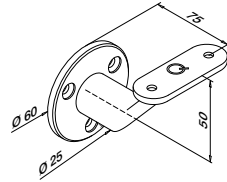

Für rundes Rohr

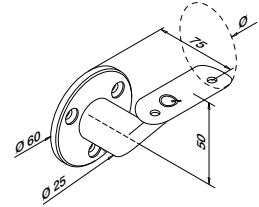

**MOD 0126**

V2A	<b>304</b>	Gebürstet		
<b>INDOOR</b>				
130126-000-12		QS-12	474	2
V4A	<b>316</b>	Gebürstet		
<b>OUTDOOR</b>				
140126-000-12		QS-13	474	2



Internationaler Geschmacksmusterschutz

**MOD 0126**

V2A	<b>304</b>	Gebürstet		
<b>INDOOR</b>				
130126-042-12	42,4	QS-10	474	2
130126-048-12	48,3	QS-10	474	2
V4A	<b>316</b>	Gebürstet		
<b>OUTDOOR</b>				
140126-042-12	42,4	QS-11	474	2

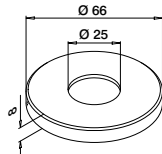

**MOD 0520**

V2A	<b>304</b>	Gebürstet		
<b>INDOOR</b>				
130520-12				2
V4A	<b>316</b>	Gebürstet		
<b>OUTDOOR</b>				
140520-12				2

**Q-INFO** | MOD 0126

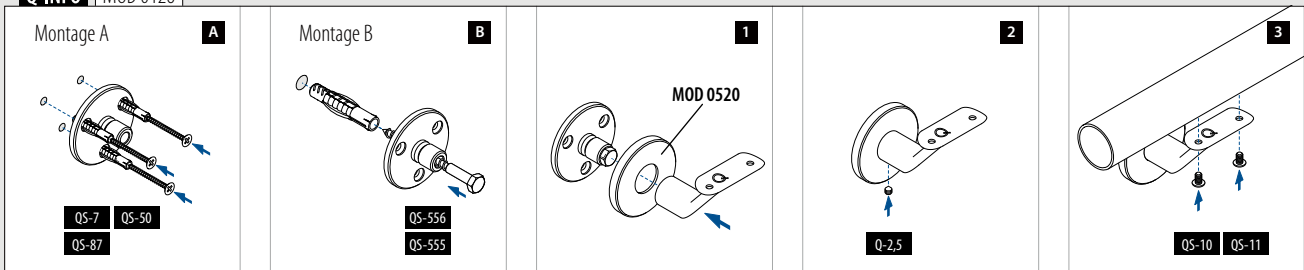

Für rundes Rohr

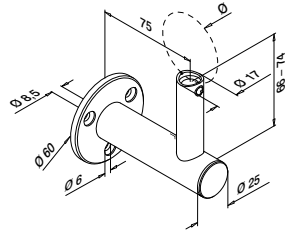

**MOD 0142**

<b>V2A</b>	<b>304</b>	Gebürstet			
	<b>INDOOR</b>	Ø			
<b>SELL OUT</b>	130142-044-12	42,4 / 48,3	QS-25	474	2
<b>V4A</b>	<b>316</b>	Gebürstet			
	<b>OUTDOOR</b>	Ø			
<b>SELL OUT</b>	140142-044-12	42,4 / 48,3	QS-71	474	2

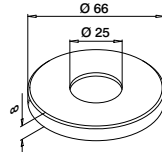

**MOD 0520**

<b>V2A</b>	<b>304</b>	Gebürstet			
	<b>INDOOR</b>				
	130520-12				2
<b>V4A</b>	<b>316</b>	Gebürstet			
	<b>OUTDOOR</b>				
	140520-12				2

**Q-INFO** MOD 0142

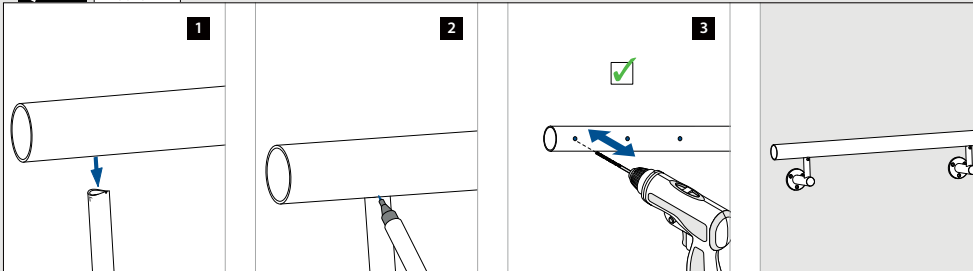

**Q-INFO** MOD 0520

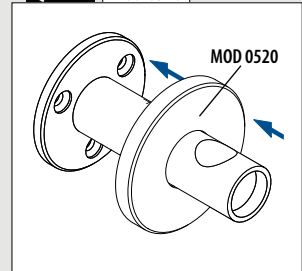

**Q-INFO** MOD 0142

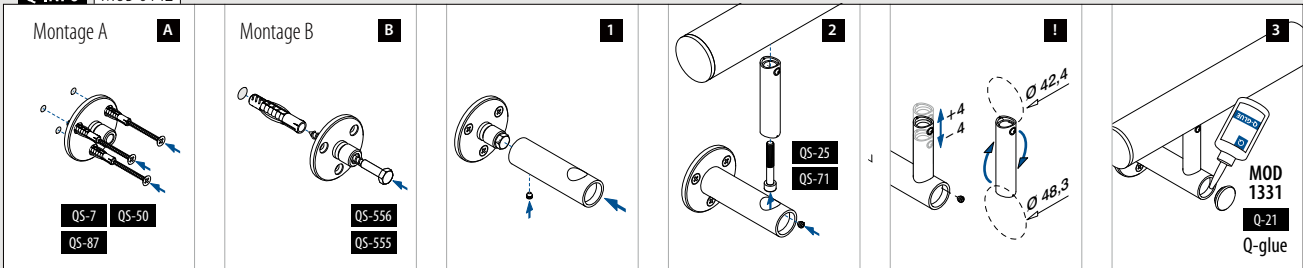

Für rundes Rohr



MOD 0110

V4A	316	Gebürstet		
	OUTDOOR	Ø		
140110	42,4	QS-11	474	2



Internationaler Geschmacksmusterschutz

Für rundes Rohr

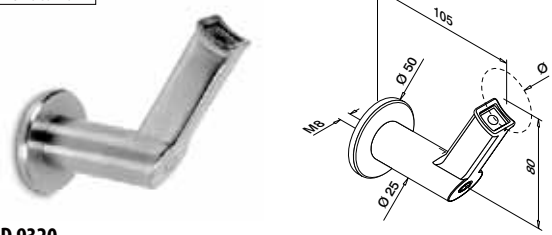

MOD 9320

V2A	304	Gebürstet		
	INDOOR	Ø		
139320-042	42,4	QS-1	473 / QS-25	474
				2



MOD 0509

V4A	316	Gebürstet		
	OUTDOOR			
140509				2

Internationaler Geschmacksmusterschutz

Q-INFO MOD 9320

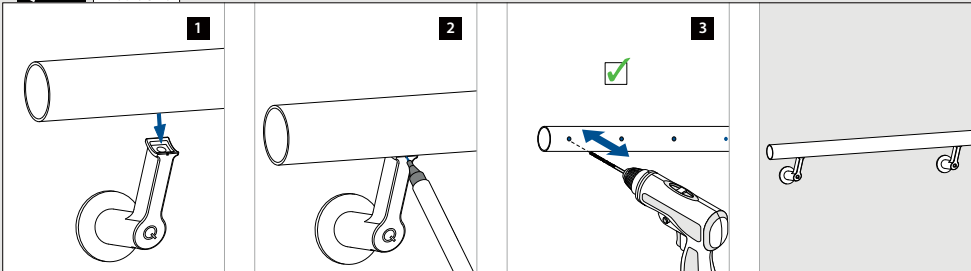

Q-INFO MOD 0110 / 0509

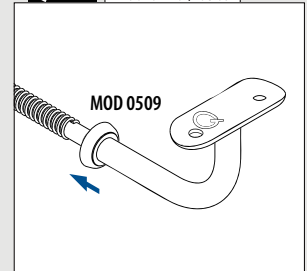

Q-INFO MOD 9320

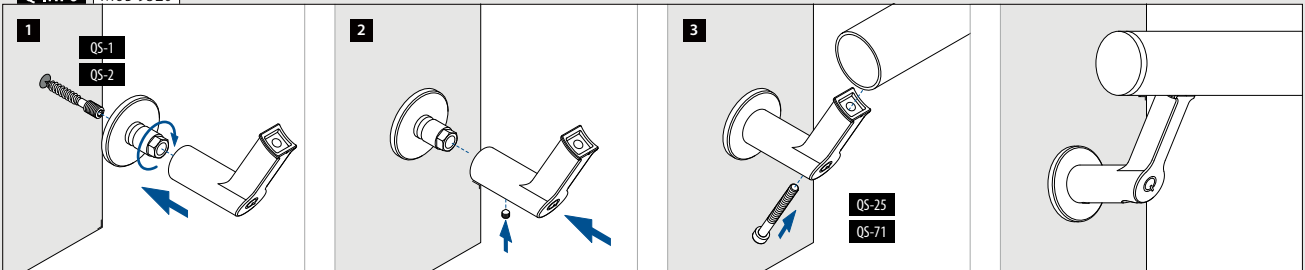

Für flaches Rohr

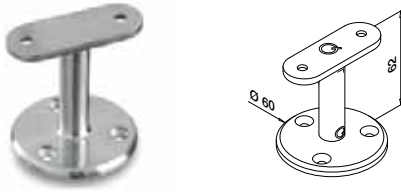

MOD 0708

V2A	304	Gebürstet		
<b>INDOOR</b>				
130708-000-12	QS-5	473 / QS-12	474	2



Für rundes Rohr

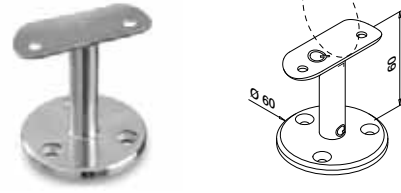

MOD 0708

V2A	304	Gebürstet		
<b>INDOOR</b>				
130708-042-12	42,4	QS-5	473 / QS-10	474
130708-048-12	48,3	QS-5	473 / QS-10	474

V4A	316	Gebürstet		
<b>OUTDOOR</b>				
140708-042-12	42,4	QS-6	473 / QS-11	474
140708-048-12	48,3	QS-6	473 / QS-11	474



für rundes Rohr zu flachem Rohr



MOD 0625

V2A	304	Gebürstet		
<b>INDOOR</b>				
130625-033-12	33,7	QS-3	473 / QS-29	474
130625-042-12	42,4	QS-3	473 / QS-29	474

V4A	316	Gebürstet		
<b>OUTDOOR</b>				
140625-042-12	42,4	QS-4	473 / QS-30	474



Für rundes Rohr



MOD 0627

V2A	304	Gebürstet		
<b>INDOOR</b>				
130627-042-12	42,4	42,4	QS-29	474



Q-INFO MOD 0708

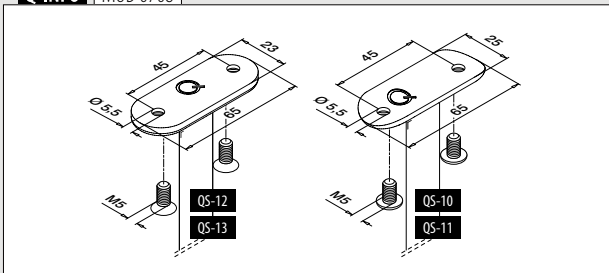

Q-INFO MOD 0625

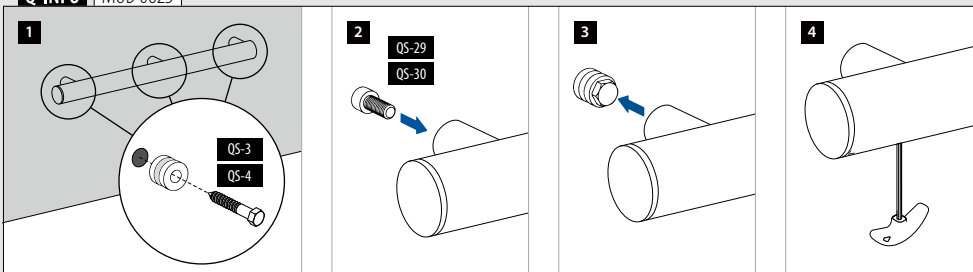

Q-INFO MOD 0627

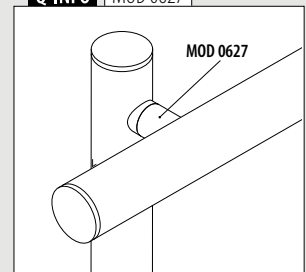





**Q-TUBE**

# **EDELSTAHLROHRE VON Q-RAILING**

NIEDRIGE TOLERANZEN  
UND MAKELLOSE OBERFLÄCHEN.

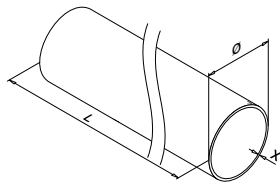
**MOD 0900**

Ø 33,7 mm

<b>V2A</b>	<b>304</b>	Gebürstet	
	<b>INDOOR</b>	<b>X</b>	
	130900-233-50-12	2,0	L = 5 m
<b>V4A</b>	<b>316</b>	Gebürstet	
	<b>OUTDOOR</b>		
	140900-233-50-12	2,0	L = 5 m

Ø 42,4 mm

<b>V2A</b>	<b>304</b>	Gebürstet	
	<b>INDOOR</b>	<b>X</b>	
<b>SELL OUT</b>	130900-242-25-12	2,0	L = 2,5 m
	130900-242-50-12	2,0	L = 5 m
<b>SELL OUT</b>	130900-042-50-12	<b>2,6</b>	L = 5 m
<b>V2A</b>	<b>304</b>	Hochglanzpoliert	
	<b>INDOOR</b>		
<b>SELL OUT</b>	130900-242-50-10	2,0	L = 5 m
<b>V2A</b>	<b>304</b>	Black Line	
	<b>INDOOR</b>		
<b>NEW</b>	130900-242-50-82	2,0	L = 5 m
<b>V4A</b>	<b>316</b>	Gebürstet	
	<b>OUTDOOR</b>		
	140900-242-25-12	2,0	L = 2,5 m
	140900-242-50-12	2,0	L = 5 m
<b>SELL OUT</b>	140900-042-50-12	<b>2,6</b>	L = 5 m
<b>V4A</b>	<b>316</b>	Hochglanzpoliert	
	<b>OUTDOOR</b>		
	140900-242-50-10	2,0	L = 5 m

Ø 48,3 mm

<b>V2A</b>	<b>304</b>	Gebürstet	
	<b>INDOOR</b>	<b>X</b>	
	130900-248-25-12	2,0	L = 2,5 m
	130900-248-50-12	2,0	L = 5 m
	130900-048-50-12	<b>2,6</b>	L = 5 m
<b>V4A</b>	<b>316</b>	Gebürstet	
	<b>OUTDOOR</b>		
	140900-248-25-12	2,0	L = 2,5 m
	140900-248-50-12	2,0	L = 5 m
<b>SELL OUT</b>	140900-048-25-12	<b>2,6</b>	L = 2,5 m
	140900-048-50-12	<b>2,6</b>	L = 5 m

Ø 60,3 mm

<b>V2A</b>	<b>304</b>	Gebürstet	
	<b>INDOOR</b>	<b>X</b>	
<b>SELL OUT</b>	130900-060-50-12	2,0	L = 5 m

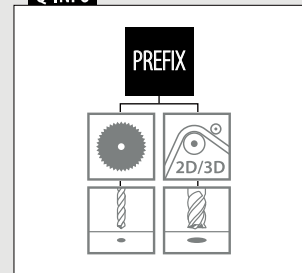
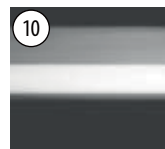

**SELL OUT** Nur solange der Vorrat reicht.

**Q-INFO****Q-INFO** 316 304

Hochglanzpoliert

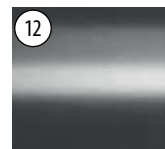

Gebürstet



Schwarz, matt, strukturiert

**Q-INFO****Sparen Sie Zeit und Geld mit Q-tube**

Q-tube hat eine viel niedrigere Toleranz als standardmäßige Rohre. Auch die Schweißnaht des Q-tubes ist speziell unseren Fittings angepasst. Die Fittinge passen dadurch perfekt in unsere Rohre, damit Sie schnell und effektiv arbeiten können. Um die Qualität zu gewährleisten und Beschädigungen zu vermeiden wird jede Rohrlänge separat verpackt.

## Verbinder



## MOD 5792 - EASY HIT®

V2A	304	Roh		
<b>INDOOR</b>				
			<b>Für Rohr Ø</b>	
SELL OUT	135792-242		42,4 x 2,0	2
SELL OUT	135792-042		42,4 x <b>2,6</b>	2
SELL OUT	135792-248		48,3 x 2,0	2
V4A	316	Roh		
<b>OUTDOOR</b>				
	145792-233		33,7 x 2,0	2
	145792-242		42,4 x 2,0	2
SELL OUT	145792-042		42,4 x <b>2,6</b>	2
	145792-248		48,3 x 2,0	2
	145792-048		48,3 x <b>2,6</b>	2



Internationaler Geschmacksmusterschutz



## MOD 0790

V2A	304	Gebürstet		
<b>INDOOR</b>				
			<b>Für Rohr Ø</b>	
	130790-233-12		33,7 x 2,0	2
	130790-242-12		42,4 x 2,0	2
SELL OUT	130790-042-12		42,4 x <b>2,6</b>	2
	130790-248-12		48,3 x 2,0	2
	130790-048-12		48,3 x <b>2,6</b>	2
V4A	316	Gebürstet		
<b>OUTDOOR</b>				
	140790-242-12		42,4 x 2,0	2
SELL OUT	140790-042-12		42,4 x <b>2,6</b>	2
	140790-248-12		48,3 x 2,0	2



## Rohrbögen



## MOD 0903

V2A	304	Gebürstet			
<b>INDOOR</b>					
			<b>Ø</b>	<b>R</b>	
	130903-242-12		42,4 x 2,0	85	1
	130903-248-12		48,3 x 2,0	97	1

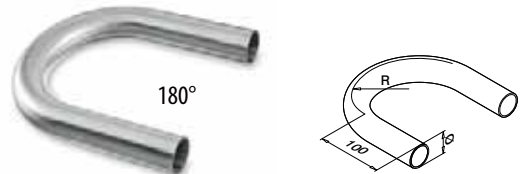

## MOD 0906

V2A	304	Gebürstet			
<b>INDOOR</b>					
			<b>Ø</b>	<b>R</b>	
	130906-242-12		42,4 x 2,0	85	1
	130906-248-12		48,3 x 2,0	97	1
V4A	316	Gebürstet			
<b>OUTDOOR</b>					
	140906-242-12		42,4 x 2,0	85	1
	140906-248-12		48,3 x 2,0	97	1

## Q-INFO | MOD 5792

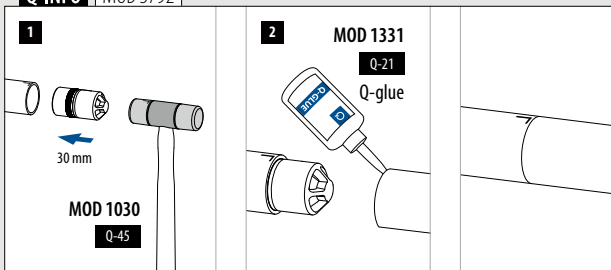

Nur solange der Vorrat reicht.

## Verbinder

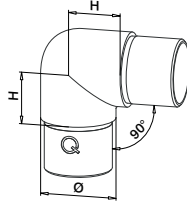

## MOD 0303

V2A	304	Gebürstet			
INDOOR		Für Rohr Ø	H		
	130303-233-12	33,7 x 2,0	25	2	
	130303-242-12	42,4 x 2,0	30	2	
SELL OUT	130303-042-12	42,4 x <b>2,6</b>	30	2	
	130303-248-12	48,3 x 2,0	35	2	
	130303-048-12	48,3 x <b>2,6</b>	35	2	
SELL OUT	130303-060-12	60,3 x 2,0	40	2	
V4A	316	Gebürstet			
OUTDOOR					
	140303-242-12	42,4 x 2,0	30	2	
SELL OUT	140303-042-12	42,4 x <b>2,6</b>	30	2	
	140303-248-12	48,3 x 2,0	35	2	
	140303-048-12	48,3 x <b>2,6</b>	35	2	
V4A	316	Hochglanzpoliert			
OUTDOOR					
	140303-242-10	42,4 x 2,0	30	2	



Kombinierbar mit 90° MOD 0710, 0810 und 4710 Handlaufstützen.

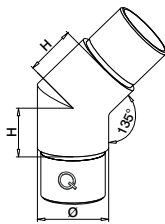

## MOD 0300

V2A	304	Gebürstet			
INDOOR		Für Rohr Ø	H		
	130300-242-12	42,4 x 2,0	30	2	
SELL OUT	130300-042-12	42,4 x <b>2,6</b>	30	2	
SELL OUT	130300-248-12	48,3 x 2,0	35	2	
V4A	316	Gebürstet			
OUTDOOR					
	140300-242-12	42,4 x 2,0	30	2	
	140300-248-12	48,3 x 2,0	35	2	

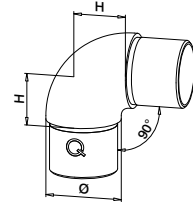

## MOD 0305

V2A	304	Gebürstet			
INDOOR		Für Rohr Ø	H		
	130305-233-12	33,7 x 2,0	25	2	
	130305-242-12	42,4 x 2,0	30	2	
	130305-248-12	48,3 x 2,0	35	2	
V4A	316	Gebürstet			
OUTDOOR					
	140305-242-12	42,4 x 2,0	30	2	
SELL OUT	140305-042-12	42,4 x <b>2,6</b>	30	2	
	140305-248-12	48,3 x 2,0	35	2	
	140305-048-12	48,3 x <b>2,6</b>	35	2	



Kombinierbar mit MOD 1820 Handlauf-Anschlussplatten.  
Nicht kombinierbar mit MOD 0710, 0810 und 4710 Handlaufstützen.

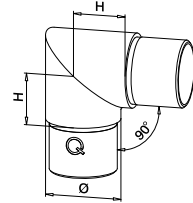

## MOD 0301

V2A	304	Gebürstet			
INDOOR		Für Rohr Ø	H		
SELL OUT	130301-233-12	33,7 x 2,0	25	2	
SELL OUT	130301-242-12	42,4 x 2,0	30	2	
V4A	316	Gebürstet			
OUTDOOR					
SELL OUT	140301-242-12	42,4 x 2,0	30	2	
SELL OUT	140301-248-12	48,3 x 2,0	35	2	



Nicht kombinierbar mit 90° MOD 0710, 0810 und 4710 Handlaufstützen.



MOD 1820  
337



MOD 0710  
325



MOD 0810  
335



MOD 4710  
294

## Q-INFO | 304 | 316

10

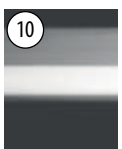

Hochglanz-  
poliert

12

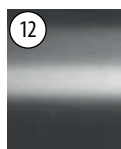

Gebürstet

Verbinder

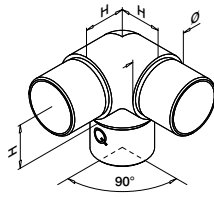

MOD 0304

V2A	304	Gebürstet			
INDOOR		Für Rohr Ø	H		
SELL OUT	130304-233-12	33,7 x 2,0	25		2
	130304-242-12	42,4 x 2,0	30		2
	130304-248-12	48,3 x 2,0	35		2

V4A	316	Gebürstet			
OUTDOOR		Für Rohr Ø	H		
	140304-242-12	42,4 x 2,0	30		2
SELL OUT	140304-042-12	42,4 x 2,6	30		2
	140304-248-12	48,3 x 2,0	35		2
SELL OUT	140304-048-12	48,3 x 2,6	35		2

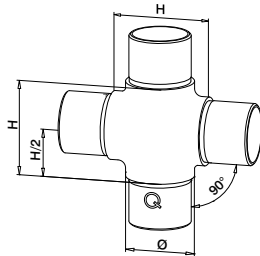

MOD 0309

V2A	304	Gebürstet			
INDOOR		Für Rohr Ø	H	H/2	
	130309-242-12	42,4 x 2,0	60	30	2

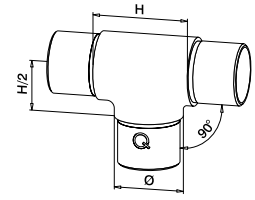

MOD 0307

V2A	304	Gebürstet			
INDOOR		Für Rohr Ø	H	H/2	
	130307-233-12	33,7 x 2,0	50	25	2
	130307-242-12	42,4 x 2,0	60	30	2
	130307-248-12	48,3 x 2,0	70	35	2

V4A	316	Gebürstet			
OUTDOOR		Für Rohr Ø	H	H/2	
	140307-242-12	42,4 x 2,0	60	30	2
	140307-248-12	48,3 x 2,0	70	35	2
	140307-048-12	48,3 x 2,6	70	35	2

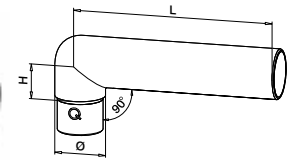

MOD 0306

V2A	304	Gebürstet			
INDOOR		Für Rohr Ø	H	L	
	130306-233	33,7 x 2,0	25	223	2
	130306-242	42,4 x 2,0	30	228	2



PFROSTENGELÄNDERSYSTEME

Q-LINE

Q-INFO MOD 0306

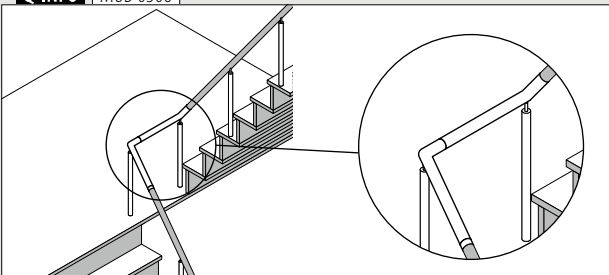

Q-INFO

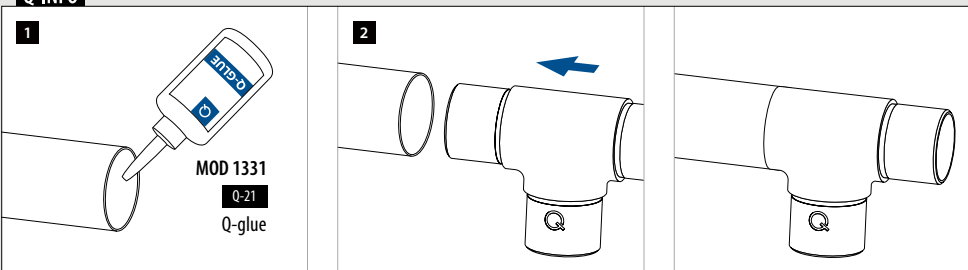

MOD 1331  
Q-21  
Q-glue



Nur solange der Vorrat reicht.

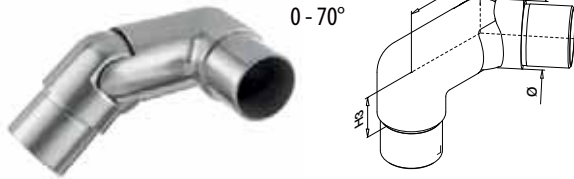

Aufwärts rechts  
Abwärts links

## MOD 0317

V2A	304	Gebürstet	INDOOR	Für Rohr Ø	H1	H2	H3	
			130317-242-01	42,4 x 2,0	27	60	30	2
			130317-248-01	48,3 x 2,0	30	65	35	2

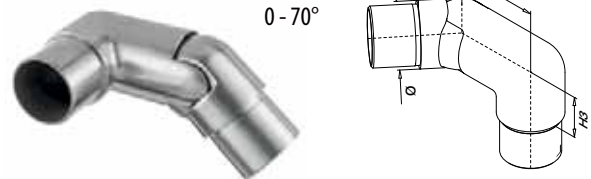
Aufwärts links  
Abwärts rechts

## MOD 0317

V2A	304	Gebürstet	INDOOR	Für Rohr Ø	H1	H2	H3	
			130317-242-02	42,4 x 2,0	27	60	30	2
			130317-248-02	48,3 x 2,0	30	65	35	2



0 - 90°



## MOD 0791

V2A	304	Gebürstet	INDOOR	Für Rohr Ø	H	
			130791-242-12	42,4 x 2,0	30	2
			130791-248-12	48,3 x 2,0	35	2

V4A	316	Gebürstet	OUTDOOR	Für Rohr Ø	H	
			140791-242-12	42,4 x 2,0	30	2



Q-INFO MOD 0317-24x-01

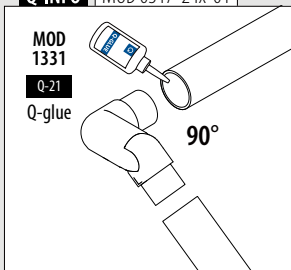

Q-INFO MOD 0317-24x-02

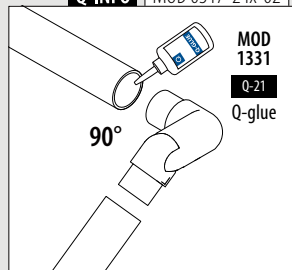



-90°  
+90°

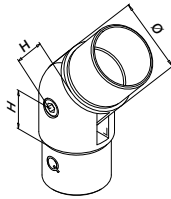

## MOD 0302

V2A	304	Gebürstet			
INDOOR		Für Rohr Ø	H		
130302-233-12	33,7 x 2,0	22	2		
130302-242-12	42,4 x 2,0	27	2		
130302-248-12	48,3 x 2,0	30	2		

V4A	316	Gebürstet			
OUTDOOR		Für Rohr Ø	H		
SELL OUT 140302-233-12	33,7 x 2,0	27	2		
140302-242-12	42,4 x 2,0	27	2		
140302-248-12	48,3 x 2,0	30	2		



0 - 70°

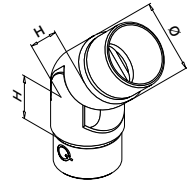

## MOD 0312

V2A	304	Gebürstet			
INDOOR		Für Rohr Ø	H		
130312-233-12	33,7 x 2,0	22	2		
130312-242-12	42,4 x 2,0	27	2		
SELL OUT 130312-042-12	42,4 x 2,6	27	2		
130312-248-12	48,3 x 2,0	30	2		
130312-048-12	48,3 x 2,6	30	2		

V4A	316	Gebürstet			
OUTDOOR		Für Rohr Ø	H		
140312-242-12	42,4 x 2,0	27	2		
SELL OUT 140312-042-12	42,4 x 2,6	27	2		
140312-248-12	48,3 x 2,0	30	2		
140312-048-12	48,3 x 2,6	30	2		
SELL OUT 140312-060-12	60,3 x 2,0	33	2		

V4A	316	Hochglanzpoliert			
OUTDOOR		Für Rohr Ø	H		
140312-242-10	42,4 x 2,0	27	2		



Internationaler Geschmacksmusterschutz

## MOD 0319

V4A	316	Gebürstet			
OUTDOOR		Für Rohr Ø	H1	H2	
140319-242-12	42,4 x 2,0	27	35	2	
140319-248-12	48,3 x 2,0	30	40	2	



Internationaler Geschmacksmusterschutz

SELL OUT Nur solange der Vorrat reicht.

## Q-INFO | MOD 0312 / 0319

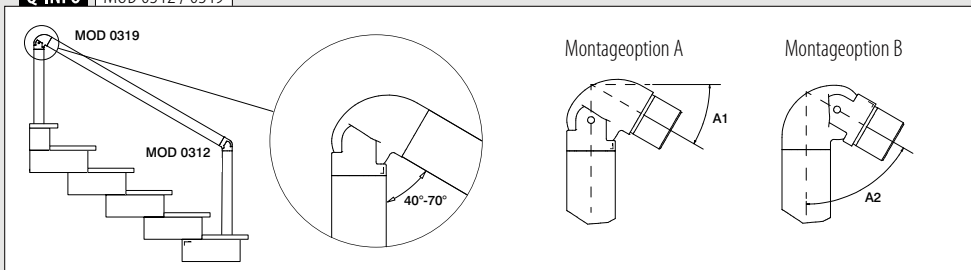

## Q-INFO | 304 | 316

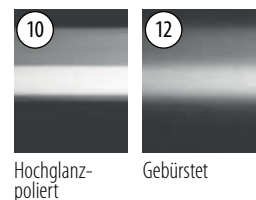

Endkappen

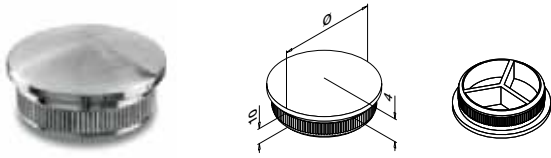

MOD 5729 - EASY HIT®

V2A	304	Gebürstet		
<b>INDOOR</b>				
			<b>Für Rohr Ø</b>	
	135729-233-12		33,7 x 2,0	2
	135729-242-12		42,4 x 2,0	2
SELL OUT	135729-042-12		42,4 x <b>2,6</b>	2
	135729-248-12		48,3 x 2,0	2
	135729-048-12		48,3 x <b>2,6</b>	2
SELL OUT	135729-060-12		60,3 x 2,0	2
V4A	316	Gebürstet		
<b>OUTDOOR</b>				
	145729-233-12		33,7 x 2,0	2
	145729-242-12		42,4 x 2,0	2
SELL OUT	145729-042-12		42,4 x <b>2,6</b>	2
	145729-248-12		48,3 x 2,0	2
	145729-048-12		48,3 x <b>2,6</b>	2

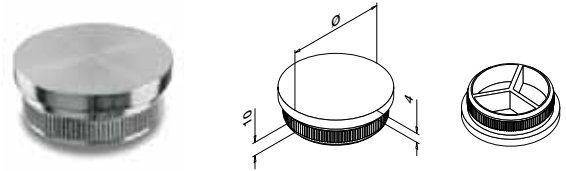

MOD 5732 - EASY HIT®

V2A	304	Gebürstet		
<b>INDOOR</b>				
			<b>Für Rohr Ø</b>	
	135732-233-12		33,7 x 2,0	2
	135732-242-12		42,4 x 2,0	2
SELL OUT	135732-042-12		42,4 x <b>2,6</b>	2
	135732-248-12		48,3 x 2,0	2
	135732-048-12		48,3 x <b>2,6</b>	2
V2A	304	Black Line		
<b>INDOOR</b>				
NEW	135732-242-82		42,4 x 2,0	2
V4A	316	Gebürstet		
<b>OUTDOOR</b>				
	145732-233-12		33,7 x 2,0	2
	145732-242-12		42,4 x 2,0	2
SELL OUT	145732-042-12		42,4 x <b>2,6</b>	2
	145732-248-12		48,3 x 2,0	2
	145732-048-12		48,3 x <b>2,6</b>	2

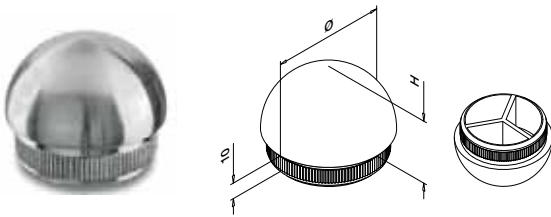

MOD 5730 - EASY HIT®

V2A	304	Gebürstet			
<b>INDOOR</b>					
			<b>Für Rohr Ø</b>	<b>H</b>	
	135730-233-12		33,7 x 2,0	17	2
	135730-242-12		42,4 x 2,0	21	2
SELL OUT	135730-042-12		42,4 x <b>2,6</b>	21	2
SELL OUT	135730-248-12		48,3 x 2,0	24	2
V4A	316	Gebürstet			
<b>OUTDOOR</b>					
	145730-242-12		42,4 x 2,0	21	2

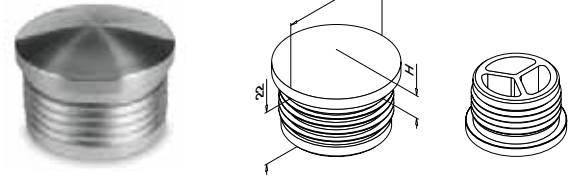

MOD 5729 - EASY HIT®

	Kunststoff	Edelstahleffekt			
<b>INDOOR</b>					
			<b>Für Rohr Ø</b>	<b>H</b>	
	155729-233		33,7 x 2,0	8	2
	155729-242		42,4 x 2,0	9	2
	155729-248		48,3 x 2,0	9	2



MOD 0729

V2A	304	Gebürstet			
<b>INDOOR</b>					
			<b>Für Rohr Ø</b>	<b>H</b>	
SELL OUT	130729-242-10		42,4 x 2,0	9	2
V4A	316	Hochglanzpoliert			
<b>OUTDOOR</b>					
	140729-242-10		42,4 x 2,0	9	2



Q-INFO | MOD 5729 / 5730 / 5732

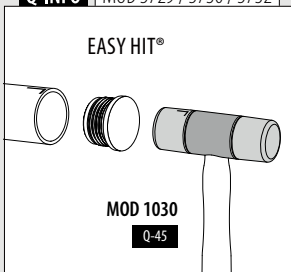

Q-INFO | MOD 0729

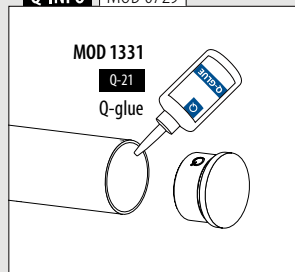

Endbögen

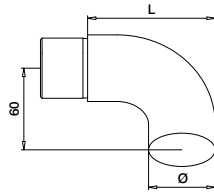

**MOD 0739**

V2A	304	Gebürstet		
	INDOOR	Für Rohr Ø	L	
	130739-233-12	33,7 x 2,0	77	2
	130739-242-12	42,4 x 2,0	81	2
SELL OUT	130739-042-12	42,4 x <b>2,6</b>	81	2
	130739-248-12	48,3 x 2,0	84	2
	130739-048-12	48,3 x <b>2,6</b>	84	2
V4A	316	Gebürstet		
	OUTDOOR			
	140739-242-12	42,4 x 2,0	81	2
SELL OUT	140739-042-12	42,4 x <b>2,6</b>	81	2
	140739-248-12	48,3 x 2,0	84	2
	140739-048-12	48,3 x <b>2,6</b>	84	2



Für Treppenmontage

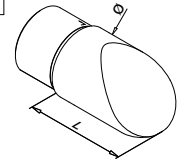

**MOD 0738**

V2A	304	Gebürstet		
	INDOOR	Für Rohr Ø	L	
	130738-242-12	42,4 x 2,0	60	2
	130738-248-12	48,3 x 2,0	65	2
V4A	316	Gebürstet		
	OUTDOOR			
	140738-242-12	42,4 x 2,0	60	2



Internationaler Geschmacksmusterschutz

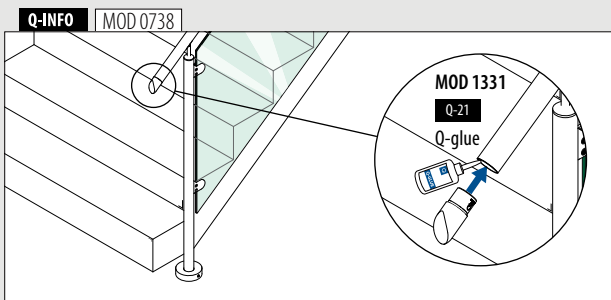

**SELL OUT** Nur solange der Vorrat reicht.

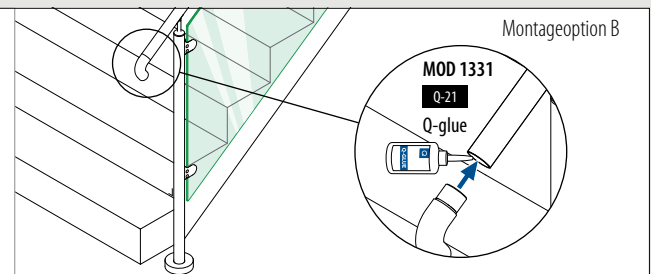
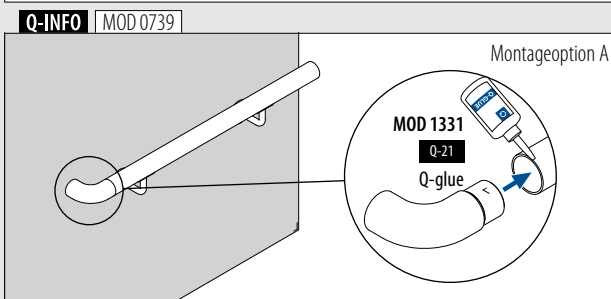

## Wandflansche

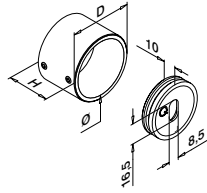

## MOD 0504

V2A	304	Gebürstet						
INDOOR		Ø	D	H				
130504-033-12	33,7	41	30	QS-55	472 / QS-21	474	2	
130504-042-12	42,4	50	35	QS-55	472 / QS-21	474	2	
130504-048-12	48,3	56	35	QS-55	472 / QS-21	474	2	

V4A	316	Gebürstet						
OUTDOOR		Ø	D	H				
140504-033-12	33,7	41	30	QS-55	472 / QS-22	474	2	
140504-042-12	42,4	50	35	QS-55	472 / QS-22	474	2	
140504-048-12	48,3	56	35	QS-55	472 / QS-22	474	2	

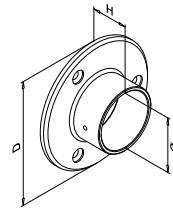

## MOD 0505

V2A	304	Gebürstet						
INDOOR		Für Rohr Ø	D	H				
130505-033-12	33,7	85	30	QS-7	473	2		
130505-042-12	42,4	95	30	QS-7	473	2		
130505-048-12	48,3	100	35	QS-7	473	2		
SELL OUT	130505-060-12	60,3	115	40	QS-7	473	2	

V4A	316	Gebürstet						
OUTDOOR		Für Rohr Ø	D	H				
NEW	140505-033-12	33,7	85	30	QS-50	473	2	
	140505-042-12	42,4	95	30	QS-50	473	2	
	140505-048-12	48,3	100	35	QS-50	473	2	

V4A	316	Hochglanzpoliert						
OUTDOOR		Für Rohr Ø	D	H				
	140505-042-10	42,4	95	30	QS-50	473	2	



## Wandflansche

Justierbar



0 - 50°

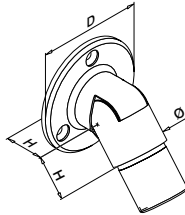

## MOD 0506

V2A	304	Gebürstet						
INDOOR		Für Rohr Ø	D	H				
SELL OUT	130506-033-12	33,7 x 2,0	70	26	QS-7	473	2	
	130506-042-12	42,4 x 2,0	75	30	QS-7	473	2	
SELL OUT	130506-048-12	48,3 x 2,0	80	33	QS-7	473	2	

V4A	316	Gebürstet						
OUTDOOR		Für Rohr Ø	D	H				
NEW	140506-033-12	33,7 x 2,0	70	26	QS-50	473	2	
NEW	140506-042-12	42,4 x 2,0	75	30	QS-50	473	2	



Internationaler Geschmacksmusterschutz

Q-INFO 304 316



Hochglanzpoliert

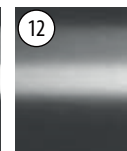

Gebürstet

Q-INFO MOD 0504

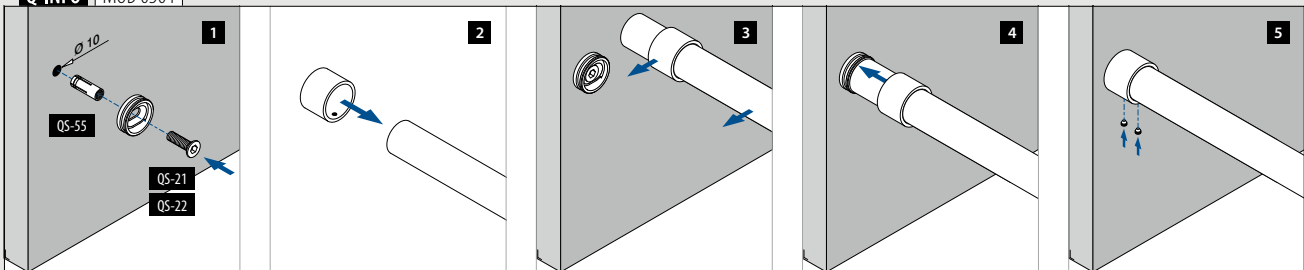





Finden Sie alle  
Informationen zu  
Barrier Line online:



[https://q-ne.ws/  
BarrierLine23](https://q-ne.ws/BarrierLine23)



# BARRIER LINE

Absperrbügel

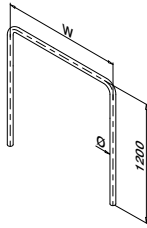

MOD 0090

V4A	316	Gebürstet			
OUTDOOR		W	Ø		
140090-248-09-12	900		48,3 x 2,0	1	
140090-248-12-12	1200		48,3 x 2,0	1	

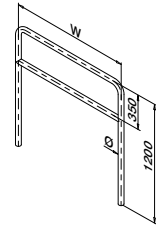

MOD 0091

V4A	316	Gebürstet			
OUTDOOR		W	Ø		
140091-248-09-12	900		48,3 x 2,0	1	
140091-248-12-12	1200		48,3 x 2,0	1	

Abdeckkappen

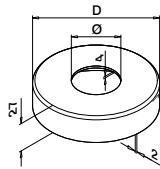

MOD 0511

V4A	316	Gebürstet			
OUTDOOR		Ø	D		
140511-048-12	48,3		120	2	

Q-INFO MOD 0090 / 0091

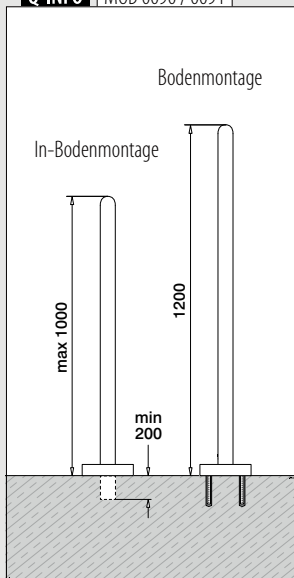

Q-INFO MOD 0090 / 0091



Q-INFO

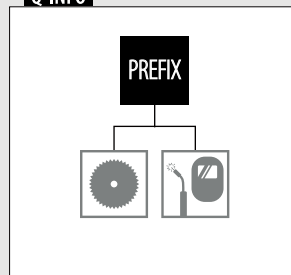

Q-INFO

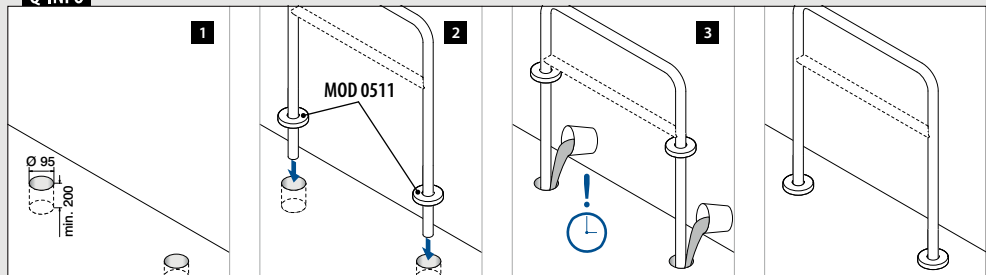





Finden Sie alle  
Informationen zu polierten  
Produkten online:

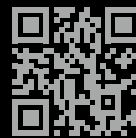

[https://q-ne.ws/  
Polished23](https://q-ne.ws/Polished23)

The background image shows a balcony with a glass railing and stainless steel posts. The view from the balcony is of a harbor with many sailboats and a town in the background, including a church with a tall spire. A green lamp is visible in the upper left corner.

# HOCHGLANZPOLIERT

## Geländerpfosten

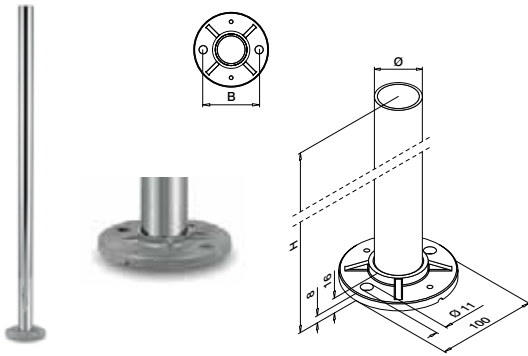

## MOD 0921

V4A	316	Hochglanzpoliert				
	<b>OUTDOOR</b>	Ø	H	B	QS-58	469
		42,4 x 2,0	989	75		1



## Abdeckkappen



## MOD 0512

V4A	316	Hochglanzpoliert			
	<b>OUTDOOR</b>	Ø	D		
		42,4	105		2

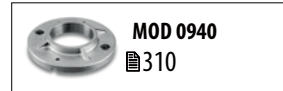
MOD 0940  
310

## Geländerpfostenhalterungen

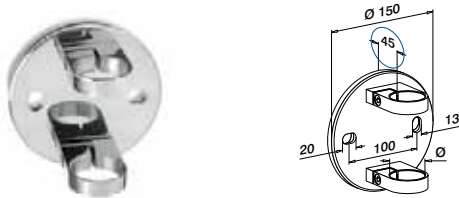

## MOD 0551

V2A	304	Hochglanzpoliert			
	<b>INDOOR</b>	Ø			
SELL OUT	130551-042-10	42,4	QS-33	466	1
V4A	316	Hochglanzpoliert			
	<b>OUTDOOR</b>	Ø			
	140551-042-10	42,4	QS-32	466	1

MOD 0900  
367

## Geländerpfostenhalterungen

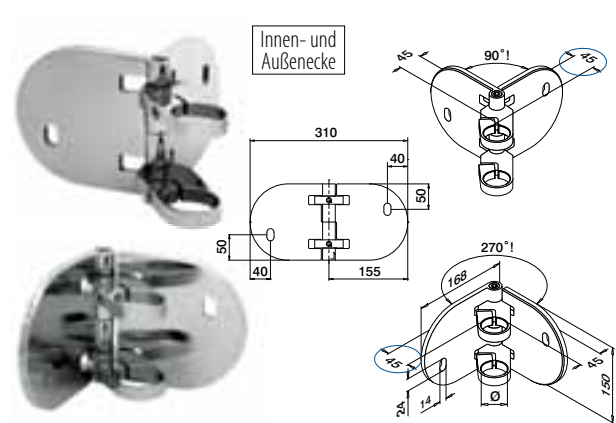

## MOD 0555

V4A	316	Hochglanzpoliert			
	<b>OUTDOOR</b>	Ø			
	140555-042-10	42,4	QS-32	466	1



SELL OUT Nur solange der Vorrat reicht.

Q-INFO MOD 0551 / 0555

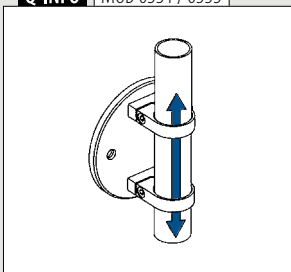

Q-INFO MOD 0921

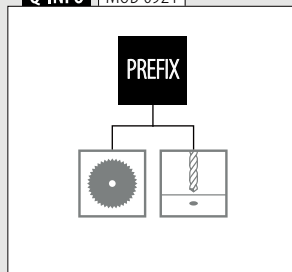

Q-INFO MOD 0551 / 0552

MOD 1035  
Q-72

Für rundes Rohr

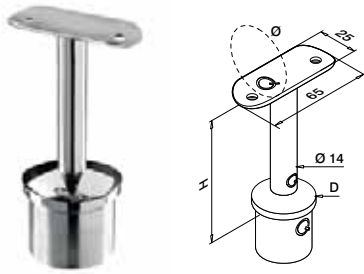

MOD 0710

V4A	316	Hochglanzpoliert					
	OUTDOOR	D	Ø	H			
140710-042-00-10	42,4 x 2,0	42,4	79	QS-11	474	2	



Für rundes Rohr

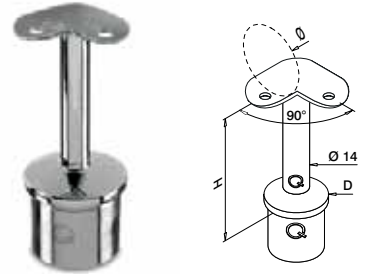

MOD 0710

V4A	316	Hochglanzpoliert					
	OUTDOOR	D	Ø	H			
140710-042-90-10	42,4 x 2,0	42,4	79	QS-11	474	2	



Für rundes Rohr

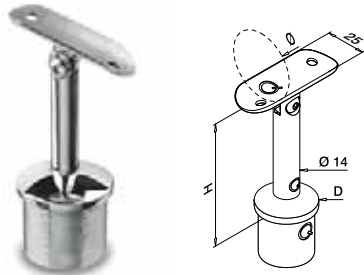

MOD 0718

V4A	316	Hochglanzpoliert					
	OUTDOOR	D	Ø	H			
140718-042-10	42,4 x 2,0	42,4	79	QS-11	474	2	



Q-INFO | MOD 071x-042-00

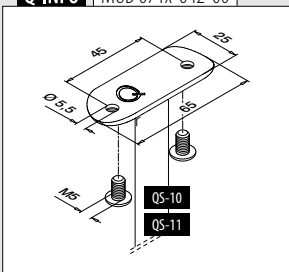

Q-INFO | MOD 0718

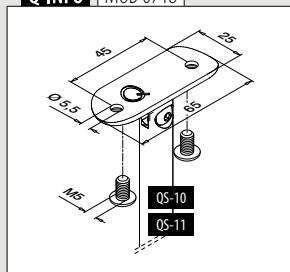

Q-INFO | MOD 071x-04x-90

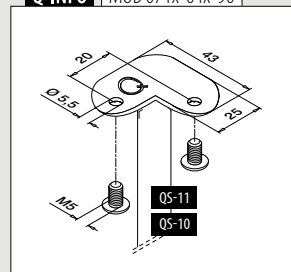

Q-INFO | MOD 071x-04x-90

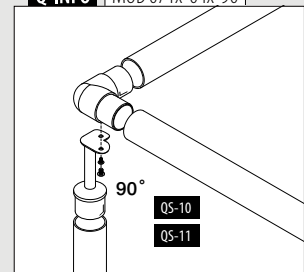



Für rundes Rohr

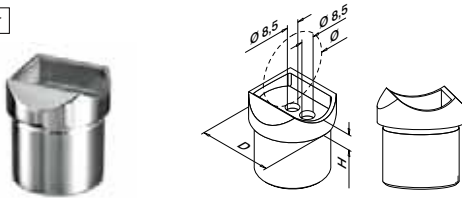

## MOD 0770

V4A	316	Hochglanzpoliert				
OUTDOOR			D	Ø	H	
140770-042-10	42,4 x 2,0	42,4	9	QS-27	474	2



Kombinierbar mit MOD 0303 Verbinders.

Für rundes Rohr

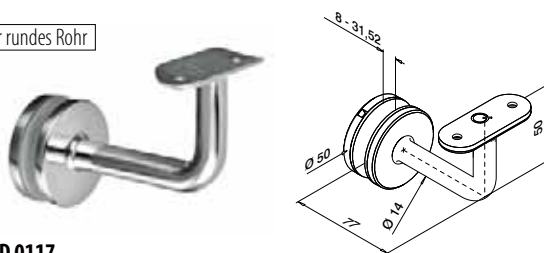

## MOD 0117

V4A	316	Hochglanzpoliert				
OUTDOOR			Ø			
140117-042-10	42,4	QS-11	474	2		
140117-048-10	48,3	QS-11	474	2		



## Q-INFO MOD 0770

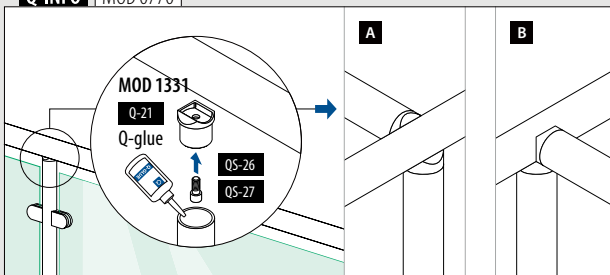

## Q-INFO MOD 0117

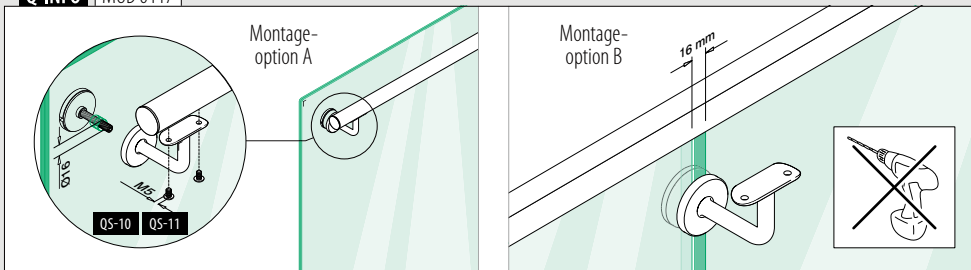

## Q-INFO MOD 0117

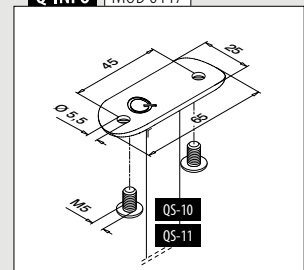

Für rundes Rohr

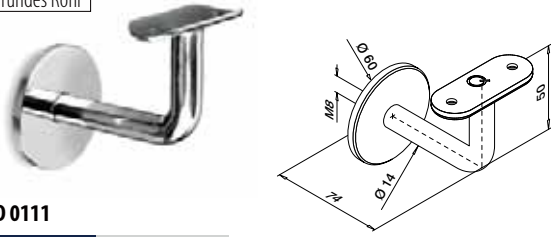

**MOD 0111**

<b>V2A</b>	<b>304</b>	Hochglanzpoliert			
	<b>INDOOR</b>	<b>Ø</b>			
<b>SELL OUT</b>	130111-042-10	42,4	QS-10	474	2
<b>V4A</b>	<b>316</b>	Hochglanzpoliert			
	<b>OUTDOOR</b>				
	140111-042-10	42,4	QS-11	474	2



Für rundes Rohr

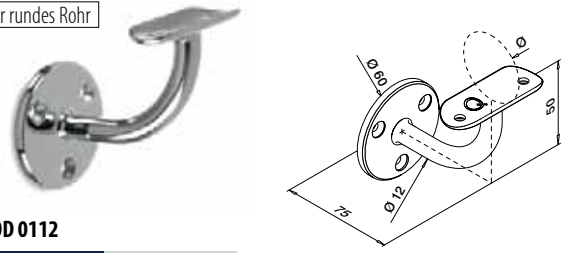

**MOD 0112**

<b>V2A</b>	<b>304</b>	Hochglanzpoliert					
	<b>INDOOR</b>	<b>Ø</b>					
<b>SELL OUT</b>	130112-042-10	42,4	QS-7	473 / QS-10	474 / QS-87	472	2
<b>V4A</b>	<b>316</b>	Hochglanzpoliert					
	<b>OUTDOOR</b>						
	140112-042-10	42,4	QS-50	473 / QS-11	474 / QS-87	472	2



**SELL OUT** Nur solange der Vorrat reicht.

**Q-INFO** MOD 0111

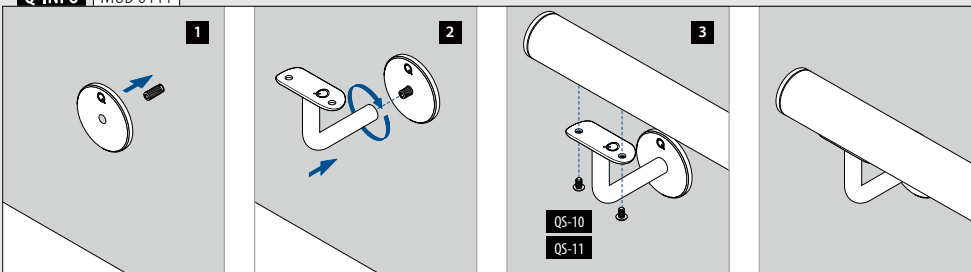

**Q-INFO**

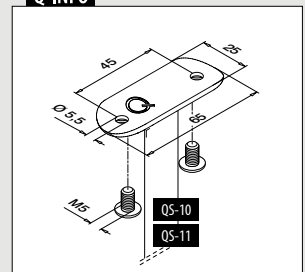

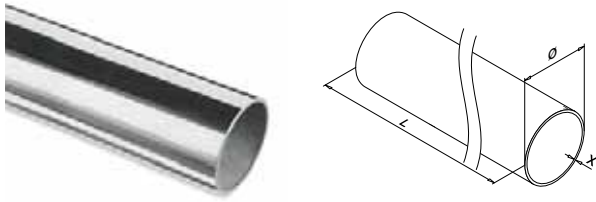

**MOD 0900**

<b>V2A</b>	<b>304</b>	Hochglanzpoliert		
	<b>INDOOR</b>	<b>Ø</b>	<b>X</b>	
<b>SELL OUT</b>	130900-242-50-10	42,4	2,0	L = 5 m
<b>V4A</b>	<b>316</b>	Hochglanzpoliert		
	<b>OUTDOOR</b>			
	140900-242-50-10	42,4	2,0	L = 5 m

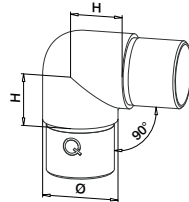
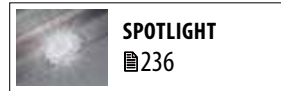

**MOD 0303**

<b>V4A</b>	<b>316</b>	Hochglanzpoliert		
	<b>OUTDOOR</b>	<b>Für Rohr Ø</b>	<b>H</b>	
	140303-242-10	42,4 x 2,0	30	2



Kombinierbar mit MOD 0710, 0810 und 4710 Handlaufstützen

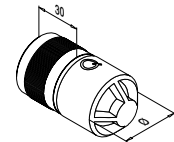

**MOD 5792 - EASY HIT®**

<b>V2A</b>	<b>304</b>	Roh		
	<b>INDOOR</b>	<b>Für Rohr Ø</b>		
<b>SELL OUT</b>	135792-242	42,4 x 2,0		2
<b>V4A</b>	<b>316</b>	Roh		
	<b>OUTDOOR</b>			
	145792-242	42,4 x 2,0		2



Internationaler Geschmacksmusterschutz

**Q-INFO** | MOD 5792

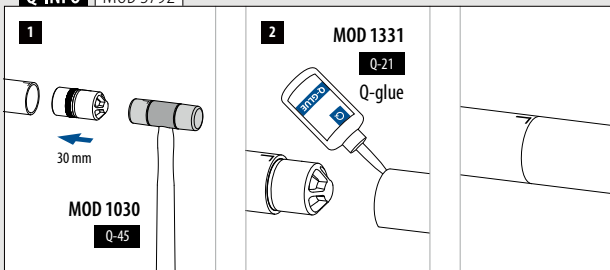

**Q-INFO** | MOD 0900

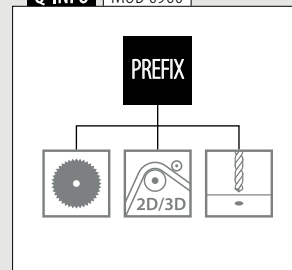



0-70°

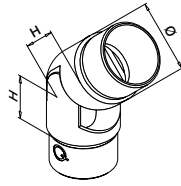

## MOD 0312

V4A	316	Hochglanzpoliert			
	<b>OUTDOOR</b>	<b>Für Rohr Ø</b>	<b>H</b>		
	140312-242-10	42,4 x 2,0	27	2	



Internationaler Geschmacksmusterschutz

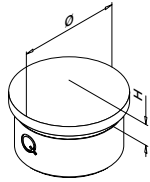

## MOD 0729

V2A	304	Hochglanzpoliert			
	<b>INDOOR</b>	<b>Für Rohr Ø</b>	<b>H</b>		
SELL OUT	130729-242-10	42,4 x 2,0	9	2	
V4A	316	Hochglanzpoliert			
	<b>OUTDOOR</b>	<b>Für Rohr Ø</b>	<b>H</b>		
	140729-242-10	42,4 x 2,0	9	2	

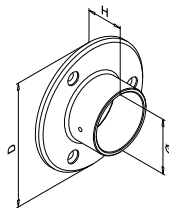

## MOD 0505

V4A	316	Hochglanzpoliert					
	<b>OUTDOOR</b>	<b>Für Ø</b>	<b>D</b>	<b>H</b>			
	140505-042-10	42,4	95	30	QS-50 ■ 473	2	



Querstabhalter

Für rundes Rohr

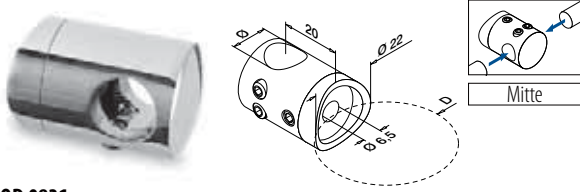

MOD 0831

V4A	316	Hochglanzpoliert			
	<b>OUTDOOR</b>	<b>D</b>	<b>Ø</b>		
140831-042-10	42,4	12	QS-16	474	4



Stäbe

Q-TUBE



MOD 1910

V4A	316	Hochglanzpoliert		
	<b>OUTDOOR</b>	<b>Ø</b>		
141910-012-50-10	12	L = 5 m		



Q-INFO MOD 1910

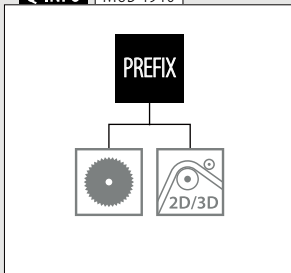

Q-INFO MOD 0831

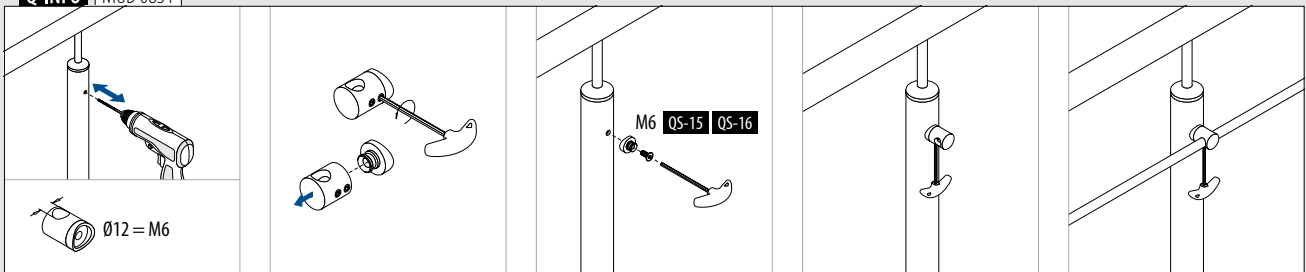



**Blechadapter - MOD 2800**

Für flaches Rohr

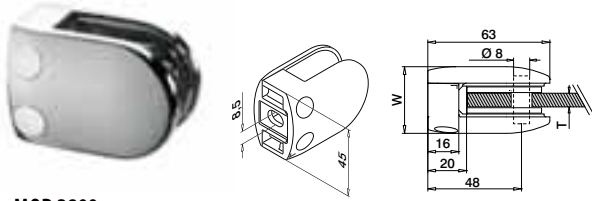

**MOD 2800**

<b>V2A</b>	<b>304</b>	Hochglanzpoliert			
<b>INDOOR</b>			<b>W</b>	<b>T</b>	
<b>SELL OUT</b>	132800-000-10	34	Siehe MOD 5028	QS-26	476 4
<b>V4A</b>	<b>316</b>	Hochglanzpoliert			
<b>OUTDOOR</b>					
	142800-000-10	34	Siehe MOD 5028	QS-27	476 4



Internationaler Geschmacksmusterschutz

Für rundes Rohr

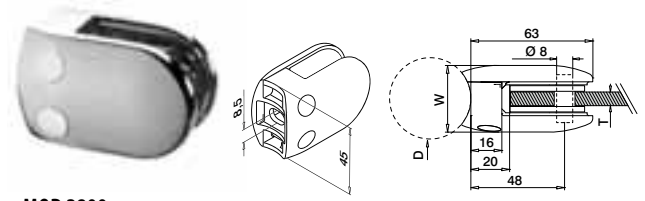

**MOD 2800**

<b>V2A</b>	<b>304</b>	Hochglanzpoliert			
<b>INDOOR</b>			<b>D</b>	<b>W</b>	<b>T</b>
<b>SELL OUT</b>	132800-042-10	42,4	34	Siehe MOD 5028	QS-47 476 4
<b>V4A</b>	<b>316</b>	Hochglanzpoliert			
<b>OUTDOOR</b>					
	142800-042-10	42,4	34	Siehe MOD 5028	QS-45 476 4



Internationaler Geschmacksmusterschutz

**Gummieinlagen für Blechadapter MOD 2800**



2 Stück pro Blechadapter

**MOD 5028**

<b>Zubehör</b>		
	<b>T</b>	
205028-02	2	8
205028-03	3	8
205028-04	4	8



**MOD 2800** Glasklemmen - hochglanzpoliert  
435

**Sicherungsstifte**

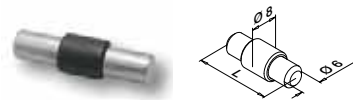

Optional verwendbar für MOD 2800

**MOD 5015**

<b>Zubehör</b>		
	<b>L</b>	
205015-22	22	4

PFSTENGELÄNDERSYSTEME  
Q-LINE - HOCHGLANZPOLIERT

**Q-INFO**

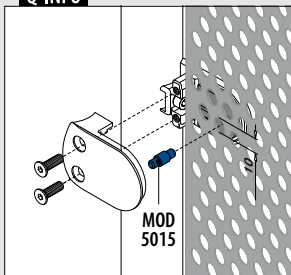

Bitte bestellen Sie Sicherungsstifte und Befestigungsmaterial separat.

**SELL OUT** Nur solange der Vorrat reicht.

**Blechadapter - MOD 4200**

Für flaches Rohr

Inklusive Sicherungsplatte

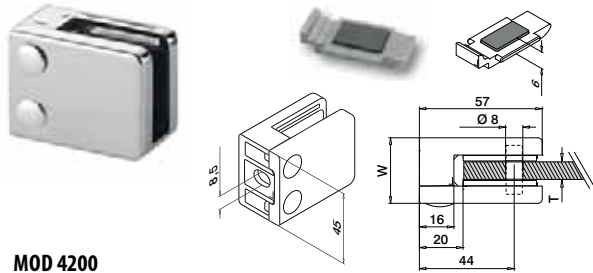

**MOD 4200**

V4A	316	Hochglanzpoliert				
	<b>OUTDOOR</b>	<b>W</b>	<b>T</b>			
144200-000-10	28	Siehe MOD 5042	QS-27	476	4	



Internationaler  
Geschmacksmusterschutz

Für rundes Rohr

Inklusive Sicherungsplatte

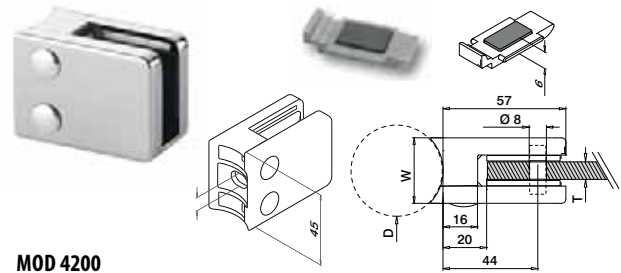

**MOD 4200**

V4A	316	Hochglanzpoliert				
	<b>OUTDOOR</b>	<b>D</b>	<b>W</b>	<b>T</b>		
144200-042-10	42,4	28	Siehe MOD 5042	QS-45	476	4
144200-048-10	48,3	28	Siehe MOD 5042	QS-45	476	4



Internationaler  
Geschmacksmusterschutz

**Gummieinlagen für Blechadapter MOD 4200**



2 Stück pro  
Blechadapter

**MOD 5042**

	<b>Zubehör</b>		
		<b>T</b>	
205042-02	2	8	
205042-03	3	8	
205042-04	4	8	

**Sicherungsstifte**

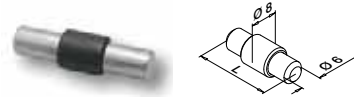

Optional verwendbar  
für MOD 4200

**MOD 5015**

	<b>Zubehör</b>		
		<b>L</b>	
205015-22	22	4	

**MOD 4200** Glasklemmen - hochglanzpoliert  
436

**Q-INFO**

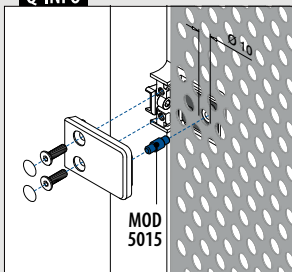



Finden Sie alle  
Informationen zu  
Schweißteilen online:



[https://q-ne.ws/  
Welding23](https://q-ne.ws/Welding23)



# SCHWEIßTEILE

Bodenflanche für Geländerpfosten

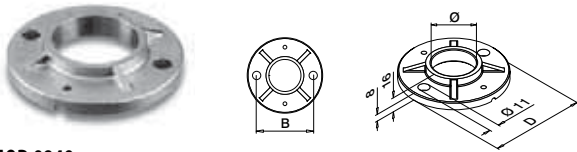

**MOD 0940**

V2A	304	Roh							
			INDOOR	Ø	B	D			
			130940-042	42,4	75	100	QS-59	469	2
			130940-048	48,3	80	100	QS-59	469	2
V4A	316	Roh							
			OUTDOOR	Ø	B	D			
			140940-042	42,4	75	100	QS-58	469	2
			140940-048	48,3	80	100	QS-58	469	2

**MOD 0941**

V4A	316	Roh							
			OUTDOOR	Ø	B	D			
			140941-048	48,3	90	120	QS-58	469	2

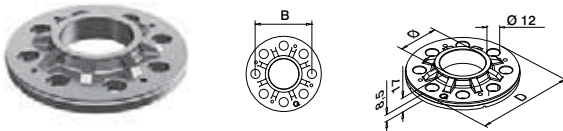

**MOD 3504**

V2A	304	Roh							
			INDOOR	Ø	B	D			
			133504-042	42,4	80	105	QS-272	466 / QS-59	469 2
			133504-048	48,3	90	115	QS-272	466 / QS-59	469 2
V4A	316	Roh							
			OUTDOOR	Ø	B	D			
			143504-042	42,4	80	105	QS-273	466 / QS-58	469 2
			143504-048	48,3	90	115	QS-273	466 / QS-58	469 2

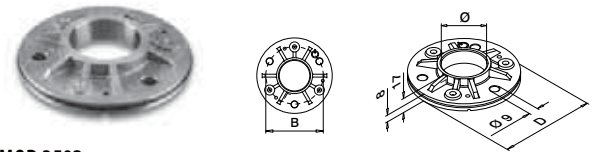

**MOD 3502**

V2A	304	Roh							
			INDOOR	Ø	B	D			
			133502-042	42,4	80	105	QS-35	469	2
			133502-048	48,3	90	115	QS-35	469	2
V4A	316	Roh							
			OUTDOOR	Ø	B	D			
			143502-042	42,4	80	105	QS-34	469	2
			143502-048	48,3	90	115	QS-34	469	2

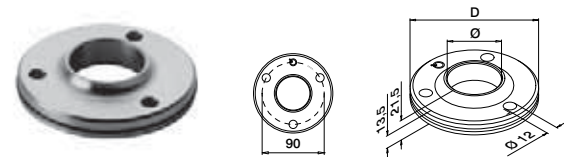

**MOD 3505**

V4A	316	Roh							
			OUTDOOR	Ø	B	D			
			143505-048	48,3	115	115	QS-273	466	2



**Q-INFO** | MOD 3504

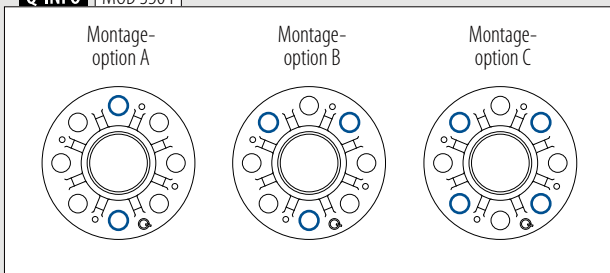

**Q-INFO** | MOD 0940

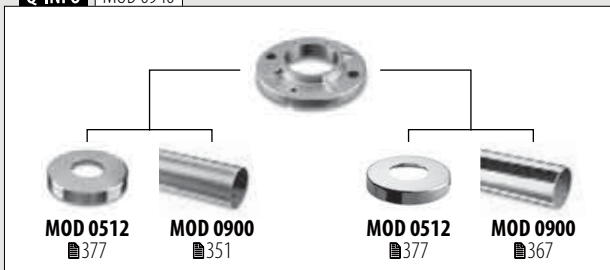

**Q-INFO** | MOD 0941



**Q-INFO** | MOD 3502 / 3505 / 3504

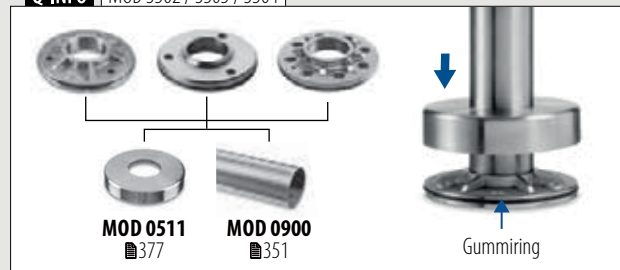

## Bodenflanche für Geländerpfosten

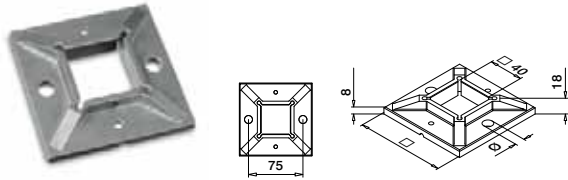

MOD 4940

V2A	304	Roh				
	<b>INDOOR</b>	□	Ø	B		
134940-040	100	11	75	QS-59	469	2

V4A	316	Roh				
	<b>OUTDOOR</b>					
144940-040	100	11	75	QS-58	469	2

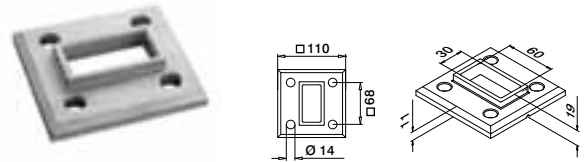

MOD 3503

V4A	316	Roh				
	<b>OUTDOOR</b>					
143503-063				QS-559	467	2

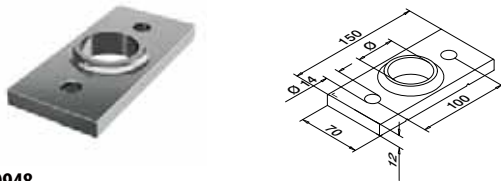

MOD 0948

V4A	316	Roh				
	<b>OUTDOOR</b>		Ø			
140948-042-00	42,4			QS-225	475	2
140948-048-00	48,3			QS-225	475	2

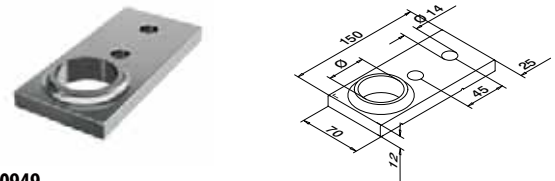

MOD 0949

V4A	316	Roh				
	<b>OUTDOOR</b>		Ø			
140949-042-00	42,4			QS-225	475	2
140949-048-00	48,3			QS-225	475	2



## Abdeckkappen für MOD 0948

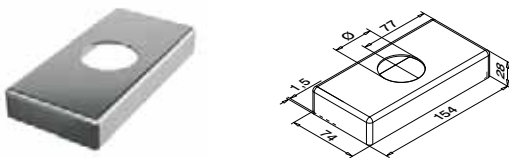

MOD 0514

V4A	316	Gebürstet				
	<b>OUTDOOR</b>		Ø			
140514-042-12	42,4					2
140514-048-12	48,3					2

NEW

## Abdeckkappen für MOD 0949

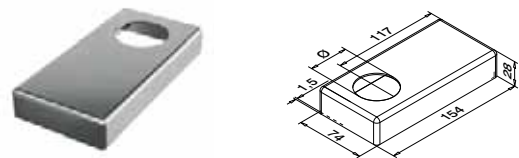

MOD 0515

V4A	316	Gebürstet				
	<b>OUTDOOR</b>		Ø			
140515-042-12	42,4					2
140515-048-12	48,3					2

NEW

Q-INFO | MOD 4940

MOD 4511  
■377MOD 4900  
■300

Q-INFO | MOD 3503

MOD 4513  
■377MOD 4900-063  
■305

Q-INFO | MOD 0948

MOD 0514  
■351MOD 0900  
■351

Q-INFO | MOD 0949

MOD 0515  
■351MOD 0900  
■351



Handlaufstützen

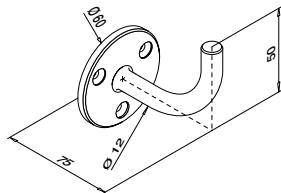

MOD 0113

V2A	<b>304</b>	Gebürstet		
<b>INDOOR</b>				
130113	QS-7	473 / QS-87	472	2
V4A	<b>316</b>	Gebürstet		
<b>OUTDOOR</b>				
140113	QS-50	473 / QS-87	472	2

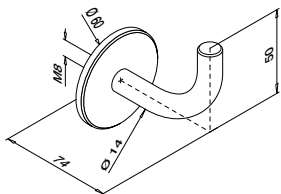

MOD 0114

V2A	<b>304</b>	Gebürstet		
<b>INDOOR</b>				
SELL OUT 130114	QS-1	473		2
V4A	<b>316</b>	Gebürstet		
<b>OUTDOOR</b>				
SELL OUT 140114	QS-2	473		2

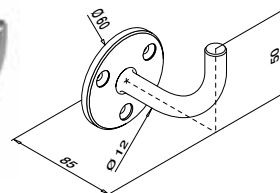

MOD 0109

V2A	<b>304</b>	Gebürstet		
<b>INDOOR</b>				
130109	QS-7	473 / QS-87	472	2

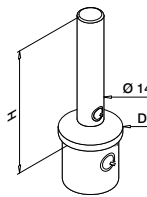

MOD 0695

V2A	<b>304</b>	Gebürstet		
<b>INDOOR</b>				
130695		D	H	2
		42,4 x 2,0	79	
V4A	<b>316</b>	Gebürstet		
<b>OUTDOOR</b>				
140695		D	H	2
		42,4 x 2,0	79	

MOD 0696

V4A	<b>316</b>	Gebürstet		
<b>OUTDOOR</b>				
140696		D	H	2
		48,3 x 2,0	80	



Flansche für Handlaufstützen

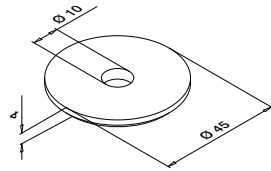

**MOD 1937**

V2A	304	Gebürstet	
<b>INDOOR</b>			
131937			4

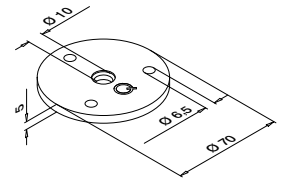

**MOD 1936**

V2A	304	Gebürstet	
<b>INDOOR</b>			
131936	QS-56	473	4

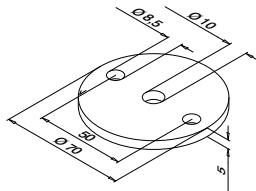

**MOD 1939**

V2A	304	Gebürstet	
<b>INDOOR</b>			
131939	QS-3	473	8



**MOD 1810**  
379

**MOD 1801**  
379

**MOD 1802**  
379

Schweißteile für Handlaufstützen

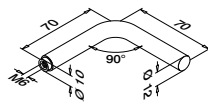

**MOD 0813**

V2A	304	Gebürstet	
<b>INDOOR</b>			
130813	QS-14	474	2

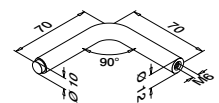

**MOD 0814**

V2A	304	Gebürstet	
<b>INDOOR</b>			
130814-670			2

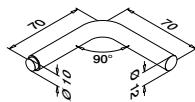

**MOD 0815**

V2A	304	Gebürstet	
<b>INDOOR</b>			
130815			2

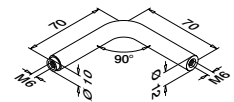

**MOD 0816**

V2A	304	Gebürstet	
<b>INDOOR</b>			
130816	QS-14	474	2



**Q-INFO** MOD 0813

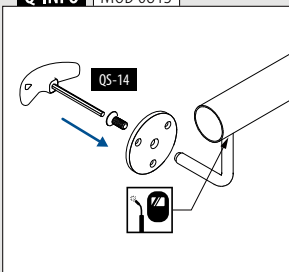

**Q-INFO** MOD 0814

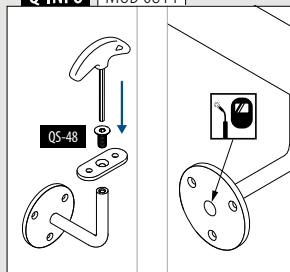

**Q-INFO** MOD 0815

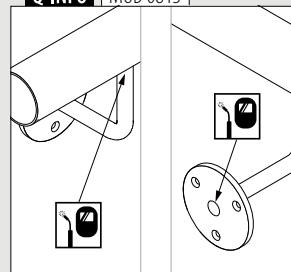

**Q-INFO** MOD 0816

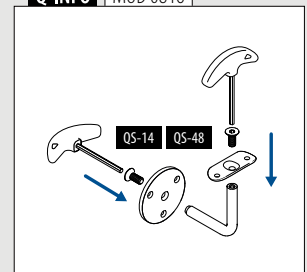

Abdeckkappen

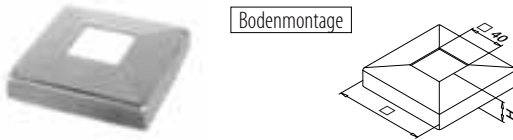

MOD 4511

V2A	<b>304</b>	Gebürstet		
	<b>INDOOR</b>		<b>H</b>	
	134511-040-12	108	25	2
V4A	<b>316</b>	Gebürstet		
	<b>OUTDOOR</b>			
	144511-040-12	108	25	2



MOD 4513

V4A	<b>316</b>	Gebürstet		
	<b>OUTDOOR</b>			
	144513-063-12			2



MOD 0519

V4A	<b>316</b>	Gebürstet		
	<b>OUTDOOR</b>			
	140519			2
	<b>Zinkdruckguss</b>	Edelstahleffekt		
	<b>INDOOR</b>			
SELL OUT	100519			2



MOD 1514

V2A	<b>304</b>	Gebürstet		
	<b>INDOOR</b>	<b>Ø</b>		
	131514-012	12,0		2
	131514-014	14,0		2



MOD 0512

V2A	<b>304</b>	Gebürstet		
	<b>INDOOR</b>	<b>Ø</b>	<b>D</b>	
	130512-033-12	33,7	105	2
	130512-042-12	42,4	105	2
	130512-048-12	48,3	105	2



MOD 1515

V2A	<b>304</b>	Gebürstet		
	<b>INDOOR</b>	<b>Ø</b>		
	131515-012	12,0		2

V4A	<b>316</b>	Gebürstet		
	<b>OUTDOOR</b>			
	140512-033-12	33,7	105	2
	140512-042-12	42,4	105	2
	140512-048-12	48,3	105	2

V4A	<b>316</b>	Hochglanzpoliert		
	<b>OUTDOOR</b>			
	140512-042-10	42,4	105	2
	140512-048-10	48,3	105	2



MOD 0511

V2A	<b>304</b>	Gebürstet		
	<b>INDOOR</b>	<b>Ø</b>	<b>D</b>	
	130511-042-12	42,4	110	2
	130511-048-12	48,3	120	2

V4A	<b>316</b>	Gebürstet		
	<b>OUTDOOR</b>			
	140511-042-12	42,4	110	2
	140511-048-12	48,3	120	2

MOD 0513

V2A	<b>304</b>	Gebürstet		
	<b>INDOOR</b>	<b>Ø</b>	<b>D</b>	
	130513-042-12	42,4	125	2
	130513-048-12	48,3	125	2
SELL OUT	130513-060-12	60,3	125	2

V4A	<b>316</b>	Gebürstet		
	<b>OUTDOOR</b>			
	140513-042-12	42,4	125	2
	140513-048-12	48,3	125	2

SELL OUT Nur solange der Vorrat reicht.

Q-INFO MOD 0519

Für MOD 0109, 0113 und 0114

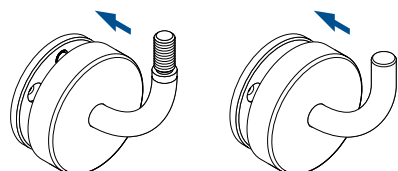

MOD 0519

MOD 0519



Handlauf-Anschlussplatten

Für flaches Rohr



MOD 1810

V2A	304	Gebürstet		
<b>INDOOR</b>				
131810-000-12	QS-48	474 / QS-10	474	8
V4A	316	Gebürstet		
<b>OUTDOOR</b>				
141810-000-12	QS-89	474 / QS-11	474	8



Für rundes Rohr



MOD 1810

V2A	304	Gebürstet			
<b>INDOOR</b>					
131810-033-12	33,7	QS-48	474 / QS-10	474	8
131810-042-12	42,4	QS-48	474 / QS-10	474	8
131810-048-12	48,3	QS-48	474 / QS-10	474	8
V4A	316	Gebürstet			
<b>OUTDOOR</b>					
141810-042-12	42,4	QS-89	474 / QS-11	474	8
141810-048-12	48,3	QS-89	474 / QS-11	474	8



Für flaches Rohr

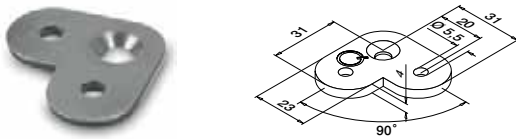

MOD 1802

V2A	304	Gebürstet		
<b>INDOOR</b>				
131802-000	QS-48	474 / QS-10	474	8



Für rundes Rohr

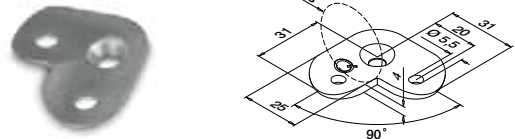

MOD 1802

V2A	304	Gebürstet			
<b>INDOOR</b>					
131802-042	42,4	QS-48	474 / QS-10	474	8
131802-048	48,3	QS-48	474 / QS-10	474	8



Für flaches Rohr

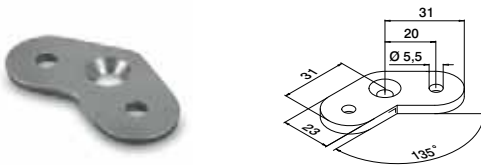

MOD 1801

V2A	304	Gebürstet		
<b>INDOOR</b>				
SELL OUT 131801-000	QS-48	474 / QS-10	474	8



Für rundes Rohr

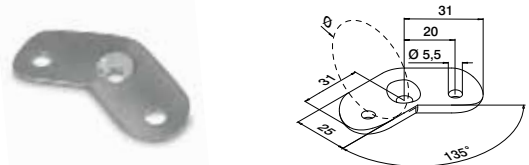

MOD 1801

V2A	304	Gebürstet			
<b>INDOOR</b>					
SELL OUT 131801-042	42,4	QS-48	474 / QS-10	474	8
SELL OUT 131801-048	48,3	QS-48	474 / QS-10	474	8



MOD 0811 335	MOD 0812 335	MOD 5735, 5736 336
-----------------	-----------------	-----------------------

MOD 1936 376	MOD 1937 376	MOD 1939 376
-----------------	-----------------	-----------------

MOD 4811 296	MOD 4733 296
-----------------	-----------------

Für rundes Rohr

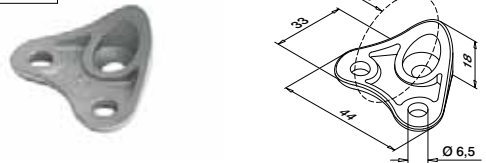

MOD 1820

V4A	316	Gebürstet			
<b>OUTDOOR</b>					
141820-042-12	42,4	QS-89	474 / QS-11	474	8

Kombinierbar mit MOD 0305 Verbinder.  
Internationaler Geschmacksmusterschutz

SELL OUT Nur solange der Vorrat reicht.

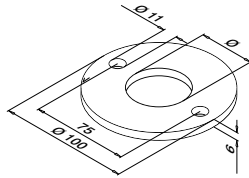

**MOD 1930**

V2A	304	Gebürstet	INDOOR	Ø	
131930-033				33,7	8
131930-042				42,4	8
131930-048				48,3	8

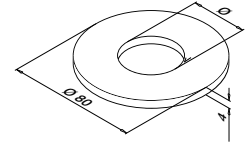
**MOD 1931**

V2A	304	Gebürstet	INDOOR	Ø	
131931-033				33,7	8
131931-042				42,4	8
131931-048				48,3	8

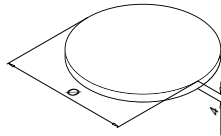
**MOD 1932**

V2A	304	Gebürstet	INDOOR	Ø	
131932-033				33,7	16
131932-042				42,4	16
131932-048				48,3	16

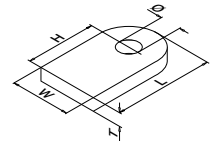
**MOD 1933**

V2A	304	Gebürstet	INDOOR	L	W	H	T	Ø	
131933-030				30	20	20	5	7	16
131933-050				50	30	35	6	9	16

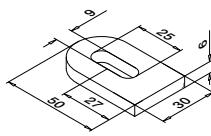
**MOD 1934**

V2A	304	Gebürstet	INDOOR	
131934-030				16

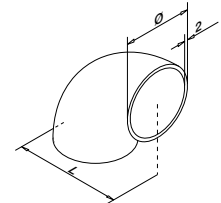
**MOD 1935**

V2A	304	Gebürstet	INDOOR	Ø	L	
131935-033				33,8 x 2,0	50	2
131935-042				42,4 x 2,0	65	2
131935-048				48,3 x 2,0	75	2



Geländerpfostenhalterungen

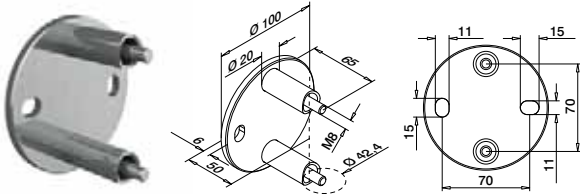

MOD 1552

V2A	304	Gebürstet		
INDOOR		Ø		
131552	42,4	QS-64	466	1

NEW

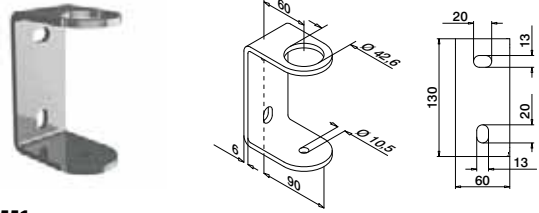

MOD 1551

V2A	304	Gebürstet		
INDOOR		Ø		
131551-042	42,4	QS-32	466	1

NEW

Handlaufstützen

Wandmontage



MOD 0191

V2A	304	Gebürstet		
INDOOR				
130191	QS-7	473 / QS-87	472	2

NEW



Bodenflansche für Geländerpfosten

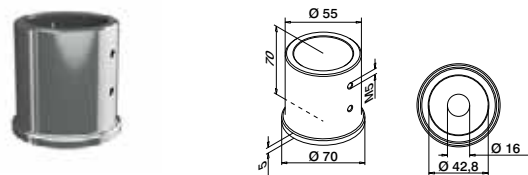

MOD 1920

V2A	304	Gebürstet		
INDOOR		Ø		
131920-042	42,4			2

NEW

Endkappen



MOD 5737 - EASY HIT®

V2A	304	Gebürstet		
INDOOR		Ø		
135737-233	33,7 x 2,0			8
135737-242	42,4 x 2,0			8

NEW

MOD 5734

V2A	304	Gebürstet		
INDOOR		Ø		
135734-233	33,7 x 2,0			8
135734-242	42,4 x 2,0			8

NEW

Handlaufstützen-Stifte



MOD 0817

V2A	304	Gebürstet		
INDOOR		L		
130817-068	68			8

NEW

MOD 0817

V2A	304	Gebürstet		
INDOOR		L		
130817-100	100			8

NEW



**d line**  
HANDRAIL SYSTEM

# Dänisches Design von *Knud Holscher.*

*“Die Anmutung eines ausdrucksstarken und minimalistischen Edelstahl-Designs wird durch das d line Geländersystem formvollendet zum Ausdruck gebracht. Diese Produktlinie überzeugt durch ihre extrem ansprechende Optik und ihre ausgereifte Funktionalität. Sie ist einfach zu montieren, flexibel zu verändern und leicht instand zu halten. d line fügt sich in die anspruchsvollsten Architekturprojekte ein und unterstreicht deren Ästhetik.”*

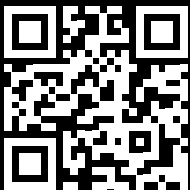

Entdecken Sie den d line Katalog auf  
<https://q-ne.ws/DLine23>



reddot



Q-railing





# BENDYWOOD

# NATURAIL

Finden Sie alle  
Informationen zu  
Holz online:

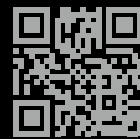

[https://q-ne.ws/  
Wood23](https://q-ne.ws/Wood23)

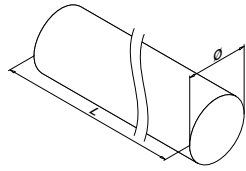

**MOD 0990****Buche** Unbehandelt**INDOOR**

Ø



170990-042-36-39

42,0

L = 3,6 m

170990-042-66-39

42,0

L = 6,6 m

PREFIX



Bitte beachten Sie die dem Produkt beiliegende Montageanleitung. Holz ist ein Naturprodukt. Farbabweichungen sind möglich.

**Q-INFO****Q-INFO**Ø 42 R<sub>min</sub> : 840 mm

Verarbeitung innerhalb von 4 Monaten nach Lieferung möglich, wenn Biegeholz in Verpackung belassen wird!

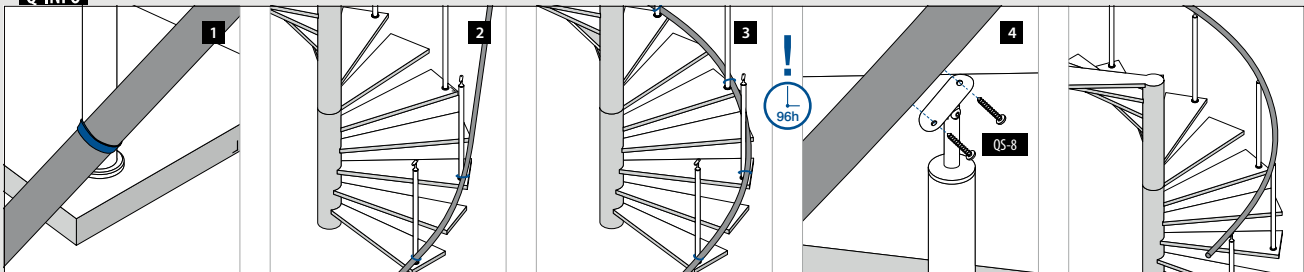
**Q-INFO**

Handläufe



MOD 0950

<b>Buche</b>	Unbehandelt		
<b>INDOOR</b>	Ø		
170950-042-25-39	42,0		L = 2,5 m

PREFIX



MOD 0950

<b>Buche</b>	Natur lackiert		
<b>INDOOR</b>	Ø		
170950-042-25-40	42,0		L = 2,5 m

PREFIX



MOD 0950

<b>Eiche</b>	Natur lackiert		
<b>INDOOR</b>	Ø		
170950-042-25-43	42,0		L = 2,5 m

PREFIX



MOD 0950

<b>Kambala</b>	Unbehandelt		
<b>OUTDOOR</b>	Ø		
170950-042-25-47	42,0		L = 2,5 m

PREFIX

Zubehör

Dübel

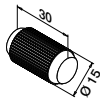

MOD 0203

<b>Holz</b>			
<b>INDOOR</b>	QS		
200203	QS-512		50

Handläufe

Verbinder

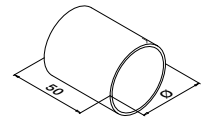

MOD 0793

<b>V2A</b>	<b>304</b>	Gebürstet		
<b>INDOOR</b>	Ø			
170793-042	42,0	QS-7	473	2
<b>V4A</b>	<b>316</b>	Gebürstet		
<b>OUTDOOR</b>				
180793-042	42,0	QS-50	473	2



Q-INFO MOD 0950

PREFIX



Q-INFO

Holz ist ein Naturprodukt.  
Farbabweichungen sind möglich.

Q-INFO MOD 0950

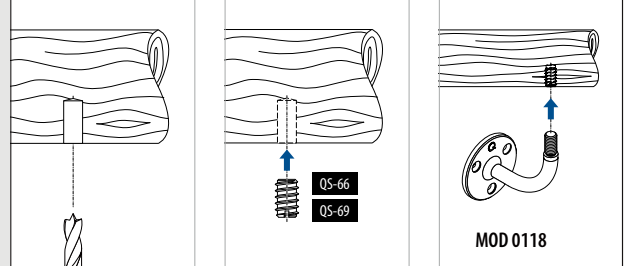

Q-INFO MOD 0950 / 0203

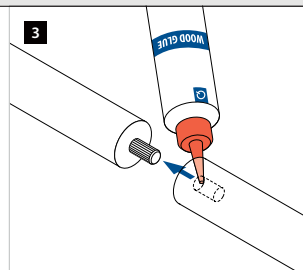
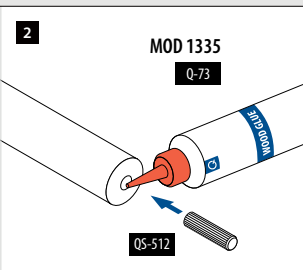
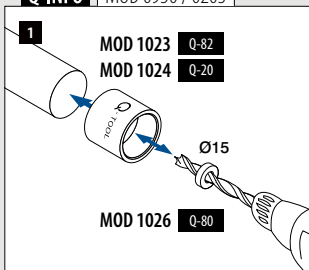

Q-INFO MOD 0950

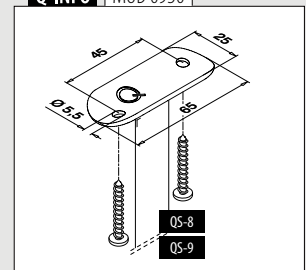



**MOD 0313**

V4A	<b>316</b>	Gebürstet			
	<b>OUTDOOR</b>	Ø			
180313-042	42,0	QS-50	473	2	

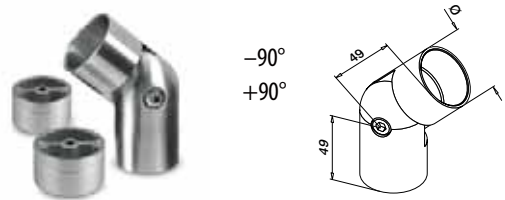

**MOD 0308**

V2A	<b>304</b>	Gebürstet			
	<b>INDOOR</b>	Ø			
170308-042	42,0	QS-7	473	2	



Adapter



**MOD 0301**

V2A	<b>304</b>	Gebürstet			
	<b>INDOOR</b>	Ø			
170301-042	42,0	QS-7	473	2	
V4A	<b>316</b>	Gebürstet			
	<b>OUTDOOR</b>	Ø			
180301-042	42,0	QS-50	473	2	



Nicht kombinierbar mit MOD 0710, 0810 und 4710 Handlaufstützen.

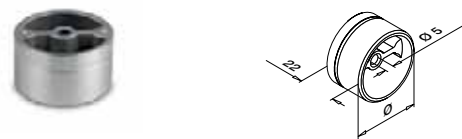

**MOD 0792**

V2A	<b>304</b>	Roh			
	<b>INDOOR</b>	Ø			
170792-042	42,0	QS-7	473	2	
V4A	<b>316</b>	Roh			
	<b>OUTDOOR</b>	Ø			
180792-042	42,0	QS-50	473	2	



Endkappen



**MOD 0732**

V2A	<b>304</b>	Gebürstet			
	<b>INDOOR</b>	Ø			
170732-042	42,0	QS-7	473	2	
V4A	<b>316</b>	Gebürstet			
	<b>OUTDOOR</b>	Ø			
180732-042	42,0	QS-50	473	2	



**MOD 0739**

V2A	<b>304</b>	Gebürstet			
	<b>INDOOR</b>	Ø			
170739-042	42,0	QS-7	473	2	



Q-INFO

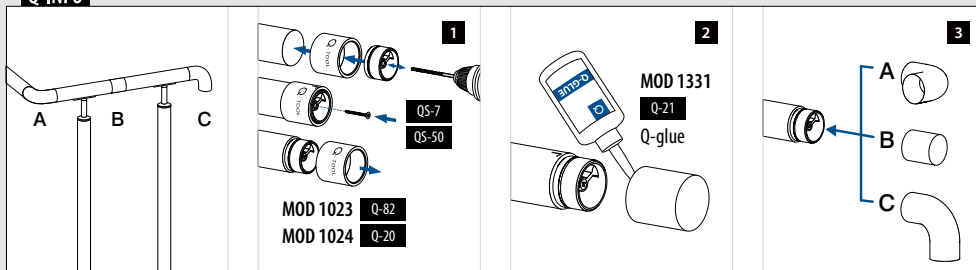



Finden Sie alle  
Informationen zu  
Glasfüllungen online:



[g-ne.ws/Infills23](https://g-ne.ws/Infills23)



Q-GLASS

# FÜLLUNGEN - GLAS

Bestellen Sie die Glaselemente zeitgleich mit allen  
anderen Produkten für Ihr Pfostengeländer

## Maßgefertigtes Glas

- 6 mm monolithisches Glas bis hin zu 21,52 mm Verbundsicherheitsglas
- Optional mit matter, farbiger oder SentryGlas®-Folie
- Abgerundete Ecken und polierte Kanten auf Anfrage
- Optional mit vorgebohrten Löchern
- Gebogenes Glas

## Glas in der Standardausführung

- Sofort ab Lager verfügbar
- Verbundsicherheitsglas
- 8,76 mm stark (6 verschiedene Glasbreiten)
- Geschliffene, gesäumte und polierte Kanten
- Abgerundete Ecken

■ CE-Kennzeichnung ■ Hohe Qualität ■ Schnelle Lieferung ■ All-inclusive-Preise ■ Einfache Bestellung

Q-GLASS (Verbund-)Sicherheitsglas

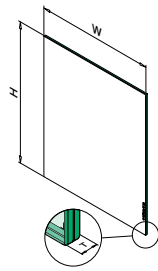

MOD 5009

(Verbund-)Sicherheitsglas ESG/VSG

OUTDOOR	H	W	T
195009-070-08	800	700	8,76
195009-080-08	800	800	8,76
195009-090-08	800	900	8,76
195009-095-08	800	950	8,76
195009-100-08	800	1000	8,76
195009-150-08	800	1500	8,76



Q-glass ist direkt ab Lager lieferbar.

Q-INFO

Berechnung

$$H (m) \times W (m) \times 2,5 \times 8 = \text{kg}$$

Beispiel



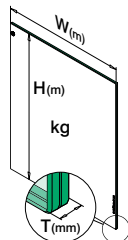

H	W	Tg
0,8 m	1,0 m	8 mm
$0,8 \times 1,0 \times 2,5 \times 8 = 16,00 \text{ kg}$		

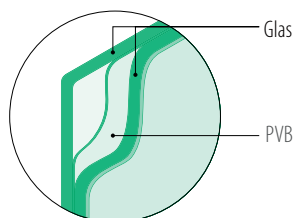
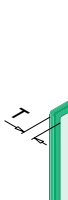

Q-INFO

(Verbund-)Sicherheitsglas



-   Geschliffene Kanten
-   Abgerundete Ecken
-   Gesäumte Kanten
-   Polierte Kanten



Halter

Für flaches Rohr

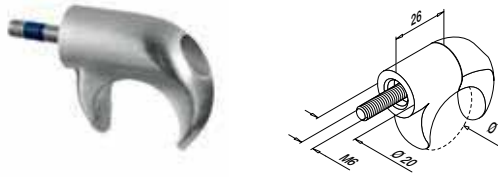

MOD 0860

V2A	304	Gebürstet		
<b>INDOOR</b>		Ø		
130860-000		30		2
V4A	316	Gebürstet		
<b>OUTDOOR</b>				
140860-000		30		2



Internationaler Geschmacksmusterschutz

Für rundes Rohr

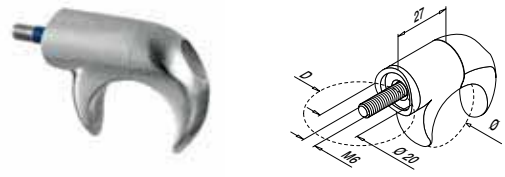

MOD 0860

V2A	304	Gebürstet		
<b>INDOOR</b>		D	Ø	
130860-042		42,4	30	2
V4A	316	Gebürstet		
<b>OUTDOOR</b>				
140860-042		42,4	30	2
SELL OUT	140860-048	48,3	30	2



Internationaler Geschmacksmusterschutz

Glasrahmenrohr

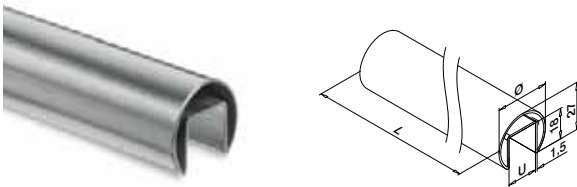

MOD 6930

V2A	304	Gebürstet		
<b>INDOOR</b>		Ø	U	
SELL OUT	136930-25-12	30	14	L = 2,5 m
	136930-50-12	30	14	L = 5 m
V4A	316	Gebürstet		
<b>OUTDOOR</b>				
SELL OUT	146930-25-12	30	14	L = 2,5 m
	146930-50-12	30	14	L = 5 m

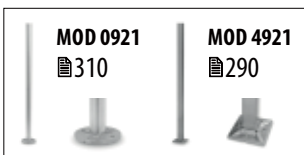

Glass Wing® Gummiprofile

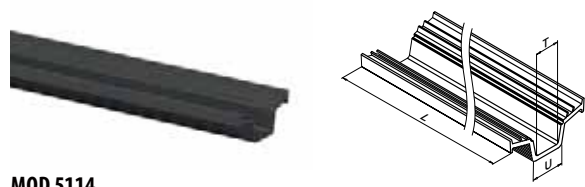

MOD 5114

<b>Zubehör</b>				
Für monolithisches Glas		U	T	
	205114-050-08	14	8	L = 5 m
	205114-050-10	14	10	L = 5 m
Für laminiertes Glas				
	205114-050-08	14	8,76 - 9,52	L = 5 m
	205114-050-10	14	10,76	L = 5 m

Internationaler Geschmacksmusterschutz

FÜLLUNGEN - GLASRAHMENROHR

SELL OUT Nur solange der Vorrat reicht.

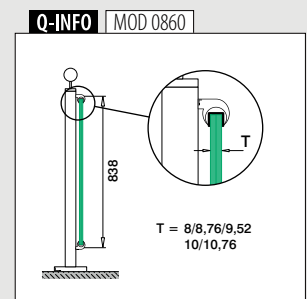
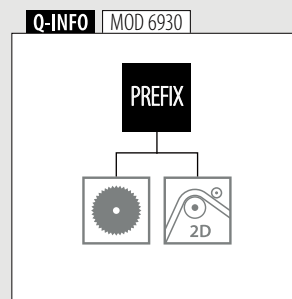
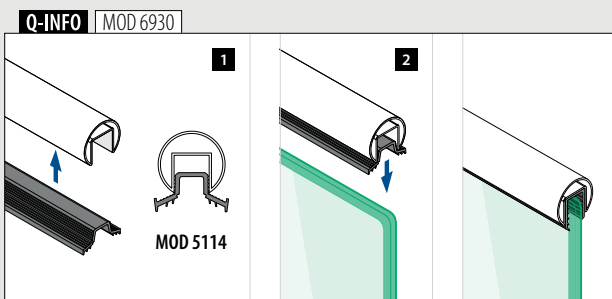



GLASRAHMENROHR

**Q-railing**

Verbinder

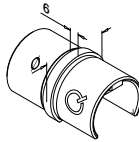

MOD 6793

V2A	304	Gebürstet		
<b>INDOOR</b>		<b>Für Rohr Ø</b>		
136793-030-12	30 x 1,5			2
V4A	316	Gebürstet		
<b>OUTDOOR</b>		<b>Für Rohr Ø</b>		
146793-030-12	30 x 1,5			2

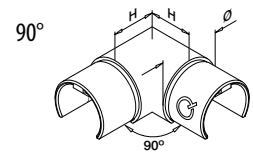

MOD 6333

V2A	304	Gebürstet		
<b>INDOOR</b>		<b>Für Rohr Ø</b>	<b>H</b>	
136333-12	30 x 1,5		25	2
V4A	316	Gebürstet		
<b>OUTDOOR</b>		<b>Für Rohr Ø</b>	<b>H</b>	
146333-12	30 x 1,5		25	2



Handläufe

Verbinder

Justierbar



Abwärts  
25-55°

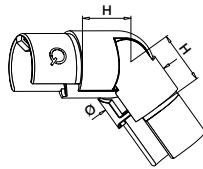

MOD 6332

V4A	316	Gebürstet		
<b>OUTDOOR</b>		<b>Für Rohr Ø</b>	<b>H</b>	
146332-02-12	30 x 1,5		25	2



Aufwärts  
25-55°

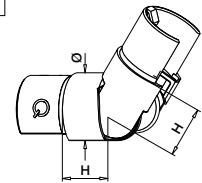

MOD 6332

V4A	316	Gebürstet		
<b>OUTDOOR</b>		<b>Für Rohr Ø</b>	<b>H</b>	
146332-01-12	30 x 1,5		25	2



Handläufe

Endkappen

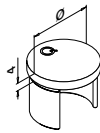

MOD 6733

V2A	304	Gebürstet		
<b>INDOOR</b>		<b>Für Rohr Ø</b>		
136733-030-12	30 x 1,5			2
V4A	316	Gebürstet		
<b>OUTDOOR</b>		<b>Für Rohr Ø</b>		
146733-030-12	30 x 1,5			2



Finden Sie alle  
Informationen zu Stab- und  
Rohrfüllungen online:

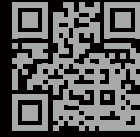

[q-ne.ws/Infills23](https://q-ne.ws/Infills23)

# FÜLLUNGEN - STAB UND ROHR

Füllungen

Stäbe

Q-TUBE

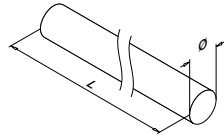

**MOD 1910**

<b>V2A</b>	<b>304</b>	Gebürstet		
<b>INDOOR</b>		<b>Ø</b>		
131910-012-25-12	12		L = 2,5 m	
131910-012-50-12	12		L = 5 m	
<b>V4A</b>	<b>316</b>	Gebürstet		
<b>OUTDOOR</b>				
141910-012-25-12	12		L = 2,5 m	
141910-012-50-12	12		L = 5 m	
<b>V4A</b>	<b>316</b>	Hochglanzpoliert		
<b>OUTDOOR</b>				
141910-012-50-10	12		L = 5 m	



Füllungen

Rohre

Q-TUBE

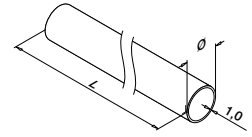

**MOD 1900**

<b>V2A</b>	<b>304</b>	Gebürstet		
<b>INDOOR</b>		<b>Ø</b>		
131900-112-25-12	12		L = 2,5 m	
131900-112-50-12	12		L = 5 m	
<b>V2A</b>	<b>304</b>	Gebürstet		
<b>INDOOR</b>				
131900-016-50-12	16		L = 5 m	
<b>V4A</b>	<b>316</b>	Gebürstet		
<b>OUTDOOR</b>				
141900-016-50-12	16		L = 5 m	



Füllungen

Verbinder

Justierbar



Für Stab  
-90°  
+90°

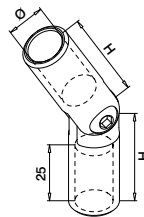

**MOD 1312**

<b>V2A</b>	<b>304</b>	Gebürstet		
<b>INDOOR</b>		<b>Ø</b>	<b>H</b>	
131312-012-12	12		36	6
<b>V4A</b>	<b>316</b>	Gebürstet		
<b>OUTDOOR</b>				
141312-012-12	12		36	6



-90°  
+90°

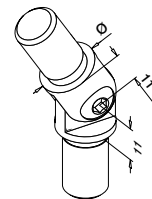

**MOD 1302**

<b>V2A</b>	<b>304</b>	Gebürstet		
<b>INDOOR</b>		<b>Für Rohr Ø</b>		
131302-016-12	16 x 1,0		6	
<b>V4A</b>	<b>316</b>	Gebürstet		
<b>OUTDOOR</b>				
141302-016-12	16 x 1,0		6	



Füllungen

Verbinder

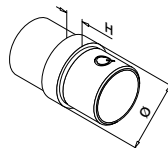

**MOD 1790**

<b>V2A</b>	<b>304</b>	Gebürstet		
<b>INDOOR</b>		<b>Für Rohr Ø</b>	<b>H</b>	
131790-112-12	12 x 1,0		5	4
131790-016-12	16 x 1,0		6	4
<b>V4A</b>	<b>316</b>	Gebürstet		
<b>OUTDOOR</b>				
141790-016-12	16 x 1,0		6	4



Q-INFO | MOD 1910 / 1900

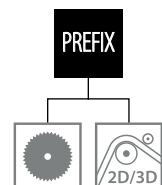



Endkappen



MOD 1729

V2A	304	Gebürstet		
<b>INDOOR</b>		<b>Für Rohr <math>\varnothing</math></b>	<b>H</b>	
131729-016-12	16,0 x 1,0	4	2	
V4A	316	Gebürstet		
<b>OUTDOOR</b>				
141729-016-12	16,0 x 1,0	4	2	

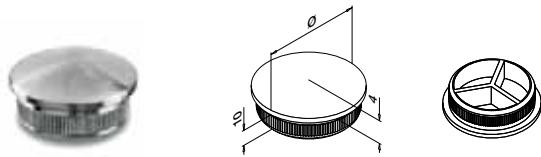

MOD 1759 - EASY HIT®

V2A	304	Gebürstet		
<b>INDOOR</b>		<b>Für Rohr <math>\varnothing</math></b>		
131759-112-12	12 x 1,0	4		
V4A	316	Gebürstet		
<b>OUTDOOR</b>				
NEW	141759-112-12	12 x 1,0	4	

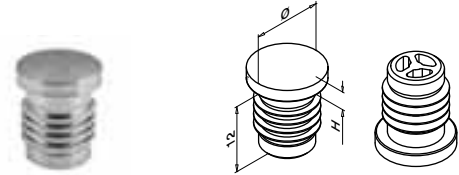

MOD 1759 - EASY HIT®

Kunststoff	Edelstahleffekt			
<b>INDOOR</b>		<b>Für Rohr <math>\varnothing</math></b>	<b>H</b>	
151759-112	12 x 1,0	3	4	
151759-016	16 x 1,0	4	4	



MOD 0735

V2A	304	Gebürstet		
<b>INDOOR</b>		<b><math>\varnothing</math></b>		
130735-012-12	12	QS-5	473	4
V4A	316	Gebürstet		
<b>OUTDOOR</b>				
140735-012-12	12	QS-6	473	4



Endstücke



MOD 0220

V2A	304	Gebürstet			
<b>INDOOR</b>		<b><math>\varnothing</math></b>	<b>H</b>	<b>d</b>	
130220-020	20	ca. 18,5	M6	6	
130220-025	25	ca. 23,5	M8	6	
130220-030	30	ca. 28,5	M8	6	
SELL OUT	130220-050	50	ca. 48,5	M8	2
V4A	316	Gebürstet			
<b>OUTDOOR</b>					
SELL OUT	140220-020	20	ca. 18,5	M6	6
SELL OUT	140220-025	25	ca. 23,5	M8	6
SELL OUT	140220-040	40	ca. 38,5	M8	2

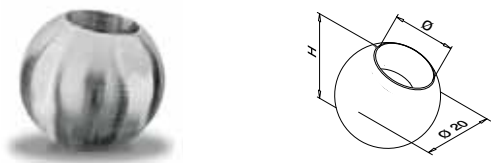

MOD 1221

V2A	304	Gebürstet		
<b>INDOOR</b>		<b><math>\varnothing</math></b>	<b>H</b>	
131221-012	12	ca. 17,5	6	
V4A	316	Gebürstet		
<b>OUTDOOR</b>				
141221-012	12	ca. 17,5	6	



Q-INFO | MOD 0735

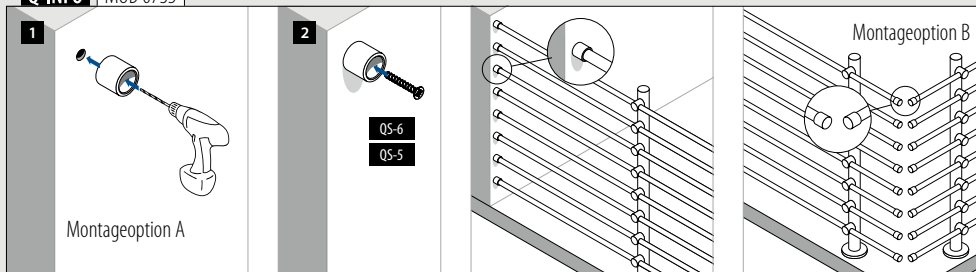

SELL OUT Nur solange der Vorrat reicht.

Querstabhalter

Für flaches Rohr

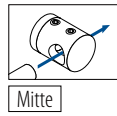
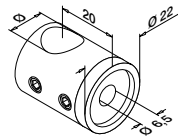

MOD 0830

V2A	304	Gebürstet			
<b>INDOOR</b>					
130830-000-12	12	QS-15	474	4	
V4A	316	Gebürstet			
<b>OUTDOOR</b>					
140830-000-12	12	QS-16	474	4	



Für flaches Rohr

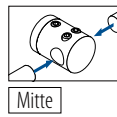
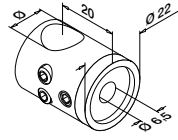

MOD 0831

V2A	304	Gebürstet			
<b>INDOOR</b>					
130831-000-12	12	QS-15	474	4	
V4A	316	Gebürstet			
<b>OUTDOOR</b>					
140831-000-12	12	QS-16	474	4	



Für flaches Rohr

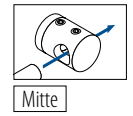
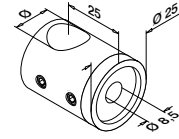

MOD 0840

V2A	304	Gebürstet			
<b>INDOOR</b>					
130840-000-12	16	QS-19	474	4	



Für flaches Rohr

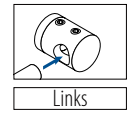
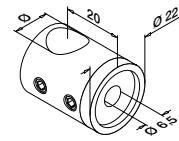

MOD 0832

V2A	304	Gebürstet			
<b>INDOOR</b>					
130832-000-12	12	QS-15	474	4	

V4A	316	Gebürstet			
<b>OUTDOOR</b>					
140832-000-12	12	QS-16	474	4	



Für flaches Rohr

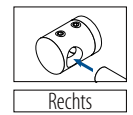
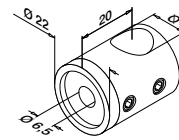

MOD 0833

V2A	304	Gebürstet			
<b>INDOOR</b>					
130833-000-12	12	QS-15	474	4	

V4A	316	Gebürstet			
<b>OUTDOOR</b>					
140833-000-12	12	QS-16	474	4	



Q-INFO MOD 0830 / 0831 / 0840

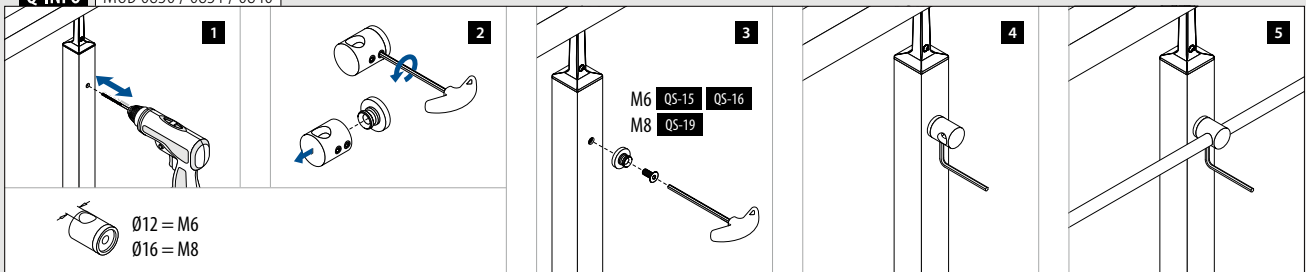

Querstabhalter

Für rundes Rohr

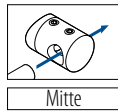
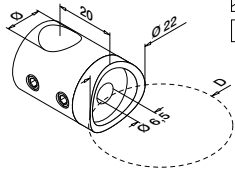

MOD 0830

V2A	304	Gebürstet				
INDOOR			D	Ø		
SELL OUT	130830-033-12		33,7	12	QS-15	474 4
	130830-042-12		42,4	12	QS-15	474 4
SELL OUT	130830-048-12		48,3	12	QS-15	474 4
V4A	316	Gebürstet				
OUTDOOR			D	Ø		
	140830-042-12		42,4	12	QS-16	474 4
	140830-048-12		48,3	12	QS-16	474 4



Für rundes Rohr

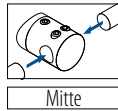
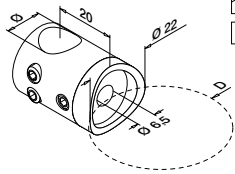

MOD 0831

V2A	304	Gebürstet				
INDOOR			D	Ø		
SELL OUT	130831-033-12		33,7	12	QS-15	474 4
	130831-042-12		42,4	12	QS-15	474 4
SELL OUT	130831-048-12		48,3	12	QS-15	474 4
V4A	316	Gebürstet				
OUTDOOR			D	Ø		
	140831-042-12		42,4	12	QS-16	474 4
	140831-048-12		48,3	12	QS-16	474 4
V4A	316	Hochglanzpoliert				
OUTDOOR			D	Ø		
	140831-042-10		42,4	12	QS-16	474 4



Für rundes Rohr

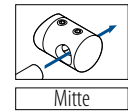
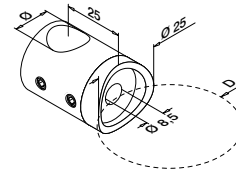

MOD 0840

V2A	304	Gebürstet				
INDOOR			D	Ø		
	130840-042-12		42,4	16	QS-19	474 4
V4A	316	Gebürstet				
OUTDOOR			D	Ø		
	140840-042-12		42,4	16	QS-20	474 4
	140840-048-12		48,3	16	QS-20	474 4



Für rundes Rohr

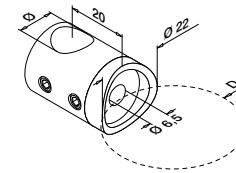

MOD 0832

V2A	304	Gebürstet				
INDOOR			D	Ø		
SELL OUT	130832-033-12		33,7	12	QS-15	474 4
	130832-042-12		42,4	12	QS-15	474 4
SELL OUT	130832-048-12		48,3	12	QS-15	474 4
V4A	316	Gebürstet				
OUTDOOR			D	Ø		
	140832-042-12		42,4	12	QS-16	474 4



Für rundes Rohr

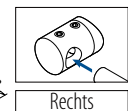
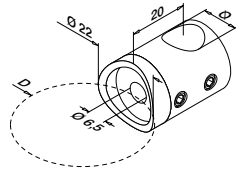

MOD 0833

V2A	304	Gebürstet				
INDOOR			D	Ø		
SELL OUT	130833-033-12		33,7	12	QS-15	474 4
	130833-042-12		42,4	12	QS-15	474 4
SELL OUT	130833-048-12		48,3	12	QS-15	474 4
V4A	316	Gebürstet				
OUTDOOR			D	Ø		
	140833-042-12		42,4	12	QS-16	474 4



SELL OUT Nur solange der Vorrat reicht.

Q-INFO 304 316



Füllungen

Querstabhalter

Für rundes Rohr

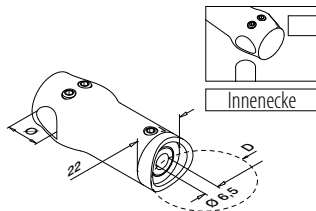

MOD 0834

V2A	304	Gebürstet			
INDOOR			D	Ø	
	130834-042-12		42,4	12	QS-15 474 4
SELL OUT	130834-048-12		48,3	12	QS-15 474 4
V4A	316	Gebürstet			
OUTDOOR			D	Ø	
	140834-042-12		42,4	12	QS-16 474 4
	140834-048-12		48,3	12	QS-16 474 4



Internationaler Geschmacksmusterschutz

Für rundes Rohr

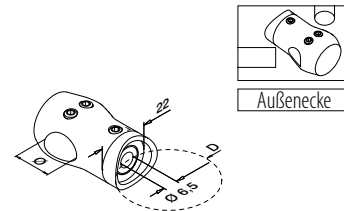

MOD 0839

V2A	304	Gebürstet			
INDOOR			D	Ø	
	130839-042-12		42,4	12	QS-15 474 4
SELL OUT	130839-048-12		48,3	12	QS-15 474 4
V4A	316	Gebürstet			
OUTDOOR			D	Ø	
	140839-042-12		42,4	12	QS-16 474 4
	140839-048-12		48,3	12	QS-16 474 4



Internationaler Geschmacksmusterschutz

Füllungen

Glasadapter

Ø 25 mm

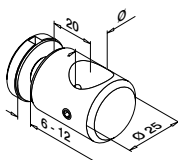

MOD 0755

V2A	304	Gebürstet		
INDOOR		Ø		
SELL OUT	130755-16	16	4	
V4A	316	Gebürstet		
OUTDOOR		Ø		
SELL OUT	140755-12	12	4	



Füllungen

Querstabhalter

Stabmontage

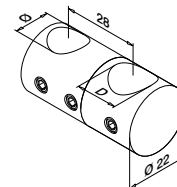

MOD 0827

V2A	304	Gebürstet			
INDOOR			D	Ø	
	130827-012		12	12	4
	130827-016		16	12	4



PFOSTENLÄNDERSYSTEME

FÜLLUNGEN - STAB UND ROHR



Nur solange der Vorrat reicht.

Q-INFO | MOD 0834 / 0839

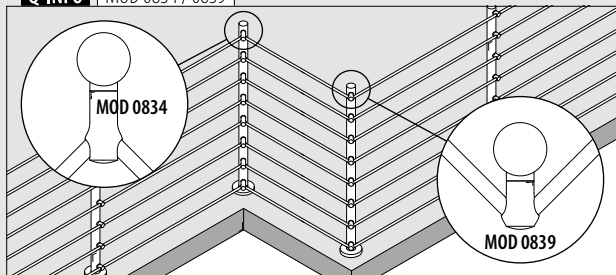

Q-INFO | MOD 0755

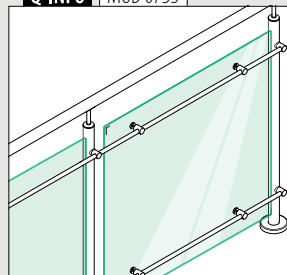

Q-INFO | MOD 0827

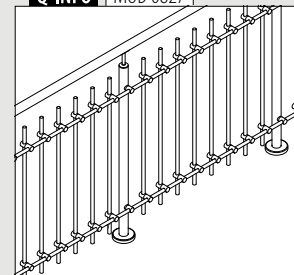

Stabhalter

Für flaches Rohr

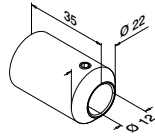

MOD 0850

V2A	304	Gebürstet		
<b>INDOOR</b>				
130850-000	QS-23	474		4
V4A	316	Gebürstet		
<b>OUTDOOR</b>				
SELL OUT	140850-000	QS-53	474	4



Für rundes Rohr

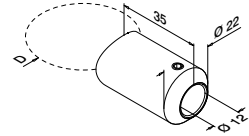

MOD 0850

V2A	304	Gebürstet		
<b>INDOOR</b>				
130850-042	D	42,4	QS-23	474
4				4
V4A	316	Gebürstet		
<b>OUTDOOR</b>				
140850-042	D	42,4	QS-53	474
4				4



Stabhalter

Justierbar

Für flaches Rohr



-90°  
+90°

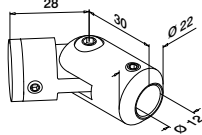

MOD 0855

V2A	304	Gebürstet		
<b>INDOOR</b>				
130855-000	QS-15	474		4



Für rundes Rohr



-90°  
+90°

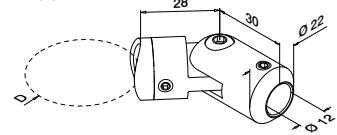

MOD 0855

V2A	304	Gebürstet		
<b>INDOOR</b>				
130855-042	D	42,4	QS-15	474
4				4



Q-INFO MOD 0850-042

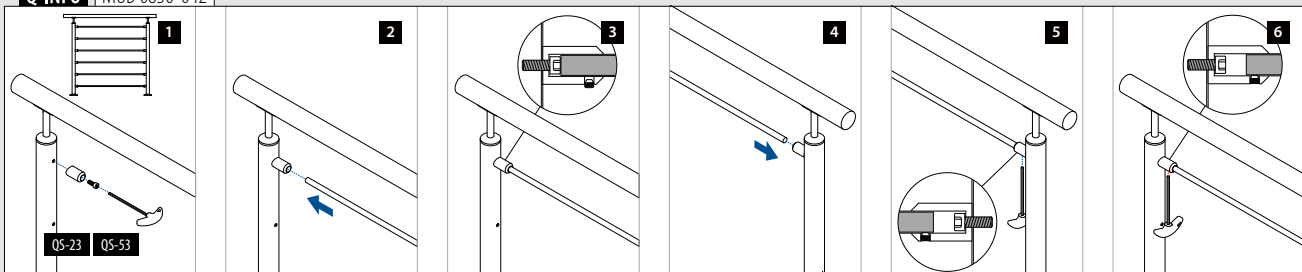





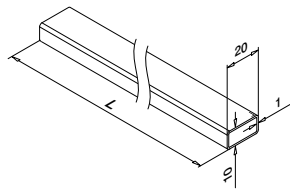

**MOD 1940**

V2A	<b>304</b>	Gebürstet		
<b>INDOOR</b>				
131940-021-50-12	20 x 10 x <b>1,0</b>		L = 5 m	
V4A	<b>316</b>	Gebürstet		
<b>OUTDOOR</b>				
141940-021-50-12	20 x 10 x <b>1,0</b>		L = 5 m	
<b>PREFIX</b>				

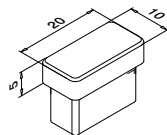

**MOD 1712**

V2A	<b>304</b>	Gebürstet		
<b>INDOOR</b>				
131712-021-12	20 x 10 x <b>1,0</b>	<b>Für Rohr</b> □		4
V4A	<b>316</b>	Gebürstet		
<b>OUTDOOR</b>				
141712-021-12	20 x 10 x <b>1,0</b>			4
			Internationaler Geschmacksmusterschutz	

Für flaches Rohr

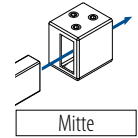
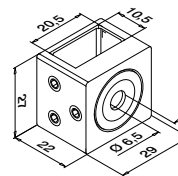

**MOD 4827**

V2A	<b>304</b>	Gebürstet		
<b>INDOOR</b>				
134827-12	20 x 10 x <b>1,0</b>	<b>Für Rohr</b> □	QS-15	4
V4A	<b>316</b>	Gebürstet		
<b>OUTDOOR</b>				
144827-12	20 x 10 x <b>1,0</b>		QS-16	4
			Internationaler Geschmacksmusterschutz	

**Q-INFO**

**Q-INFO** MOD 1940

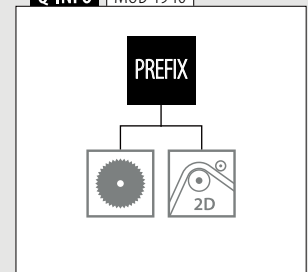
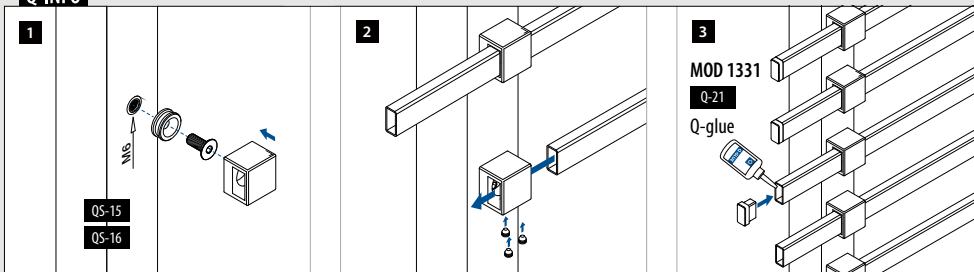



Rohre für Stabausfachung (vertikale Geländerfüllung)

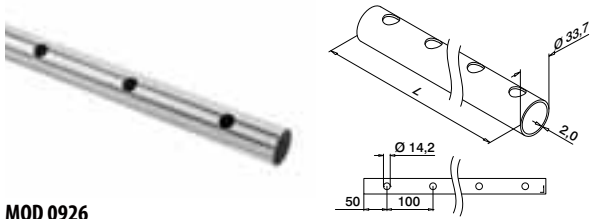

MOD 0926

V4A	316	Gebürstet
<b>OUTDOOR</b>		
140926-233-25-12	L = 2,5 m	



Adapter für Stabausfachung (vertikale Geländerfüllung)

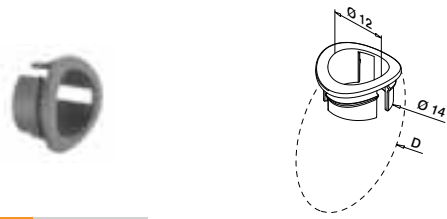

MOD 0521

	<b>Kunststoff</b>	Edelstahleffekt
<b>OUTDOOR</b>		
SELL OUT 150521	D	50

Stäbe für Stabausfachung (vertikale Geländerfüllung)

Q-TUBE



MOD 1910

V4A	316	Gebürstet
<b>OUTDOOR</b>		
141910-012-25-12	12	L = 2,5 m
141910-012-50-12	12	L = 5 m



Q-INFO MOD 0926

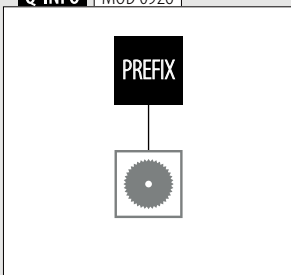

Q-INFO MOD 1910

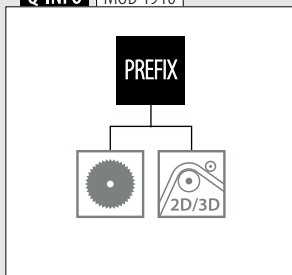

SELL OUT Nur solange der Vorrat reicht.

Q-INFO

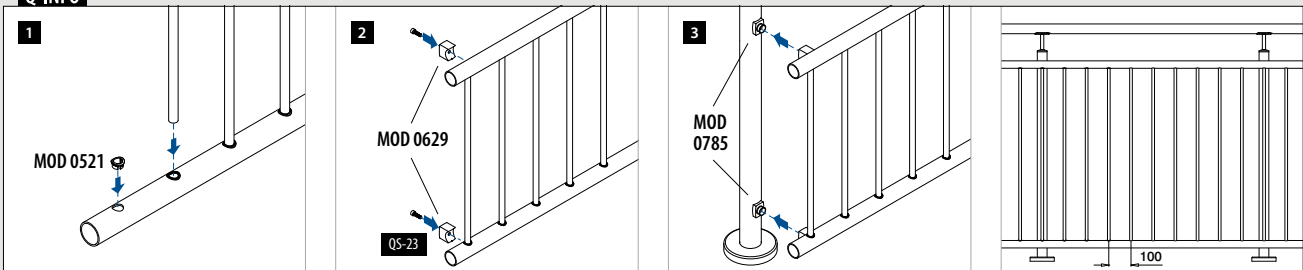

Rohradapter

Für rundes Rohr

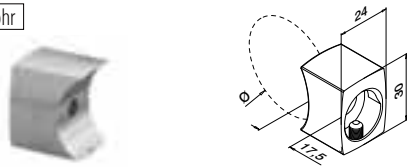

MOD 0629

V4A	316	Gebürstet		
	<b>OUTDOOR</b>	<b>Ø</b>		
140629-033	33,7	QS-53	474	4
140629-042	42,4	QS-53	474	4



Internationaler Geschmacksmusterschutz

Adapter für Rohradapter MOD 0629

Für flaches Rohr



MOD 0785

V4A	316	Gebürstet		
	<b>OUTDOOR</b>			
140785-000-12	33,7	QS-16	474	4



Für rundes Rohr

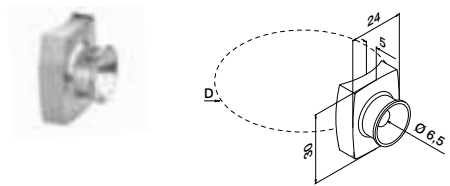

MOD 0785

V4A	316	Gebürstet		
	<b>OUTDOOR</b>	<b>D</b>		
140785-042-12	42,4	QS-16	474	4
140785-048-12	48,3	QS-16	474	4



Verbinder

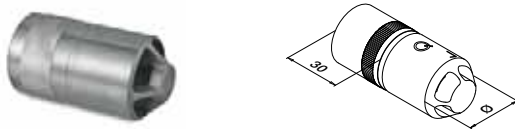

MOD 5792 - EASY HIT®

V4A	316	Roh		
	<b>OUTDOOR</b>	<b>Für Rohr Ø</b>		
145792-233	33,7	2,0		2



Internationaler Geschmacksmusterschutz

Q-INFO | MOD 5792

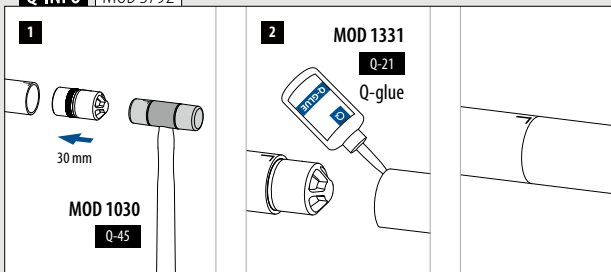

Nur solange der Vorrat reicht.



Endkappen

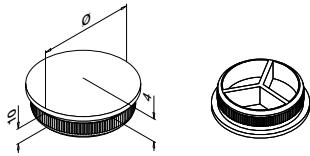

MOD 5729 - EASY HIT®

V4A	316	Gebürstet		
	<b>OUTDOOR</b>		<b>Für Rohr Ø</b>	
145729-233-12			33,7 x 2,0	2

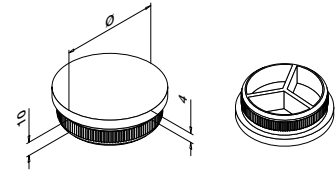

MOD 5732 - EASY HIT®

V4A	316	Gebürstet		
	<b>OUTDOOR</b>		<b>Für Rohr Ø</b>	
145732-233-12			33,7 x 2,0	2



Wandflansche

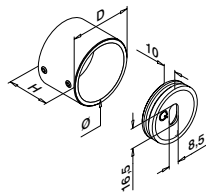

MOD 0504

V4A	316	Gebürstet					
	<b>OUTDOOR</b>		<b>Ø</b>	<b>D</b>	<b>H</b>		
140504-033-12			33,7	41	30	QS-55  472 / QS-22  474	2



Q-INFO MOD 0504

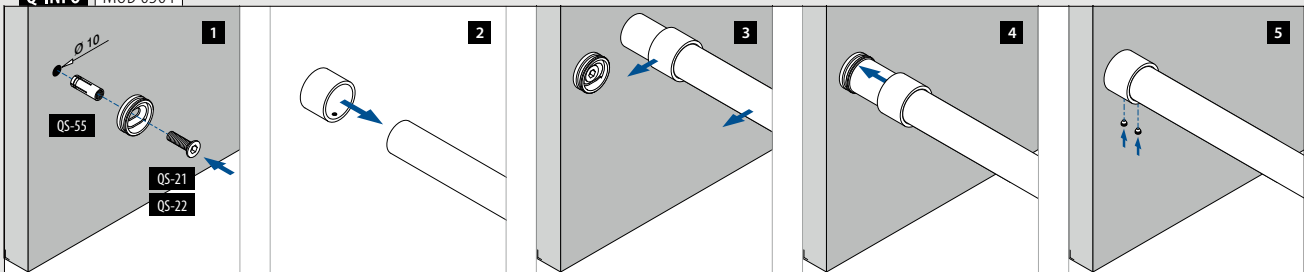



Finden Sie alle  
Informationen zu  
Drahtseifüllungen online:

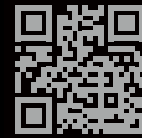

[g-ne.ws/lnfills23](https://g-ne.ws/lnfills23)

# FÜLLUNGEN - DRAHTSEIL

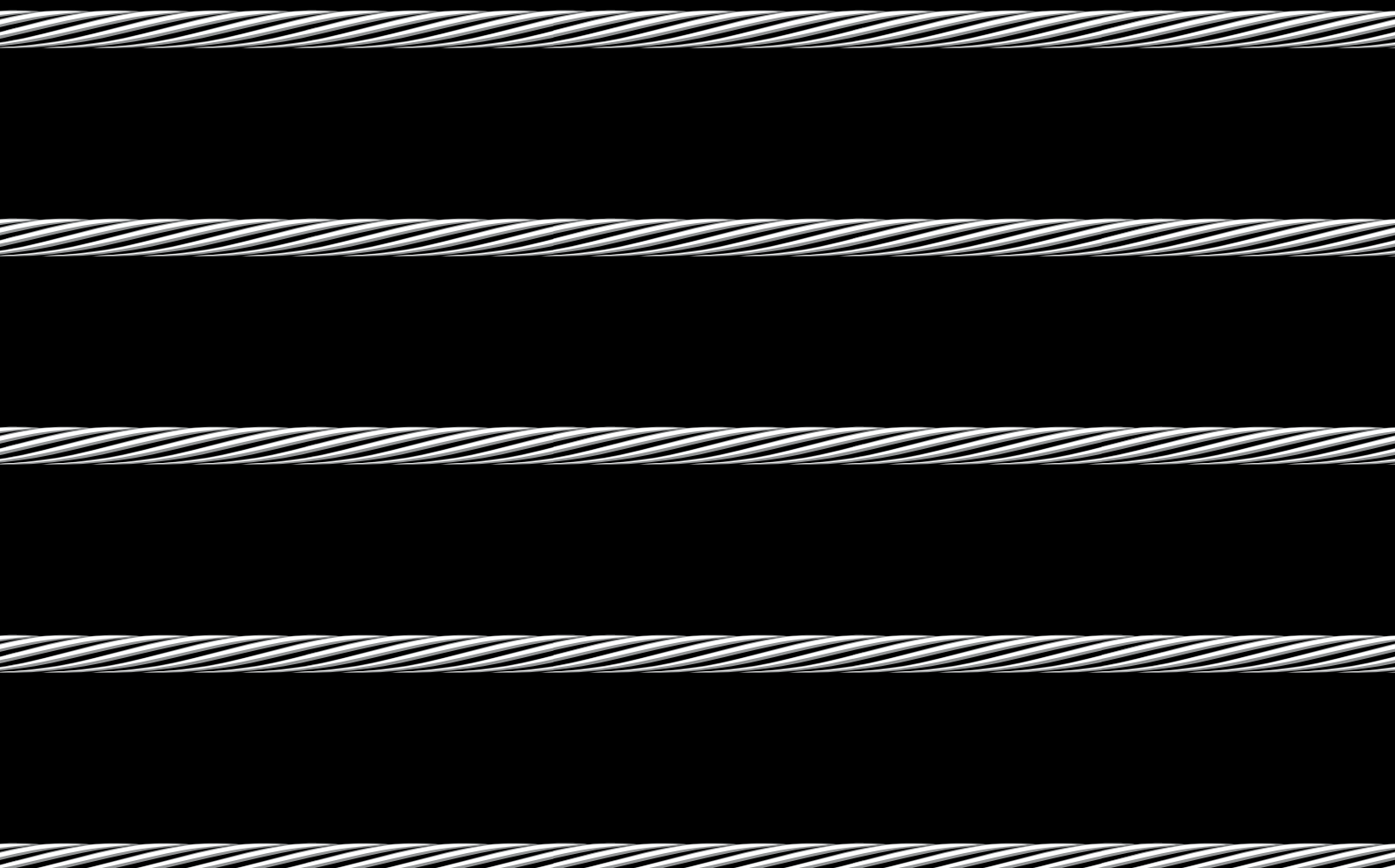

Füllungen

### Drahtseilsystem, 3,2 mm

Komplettes Set

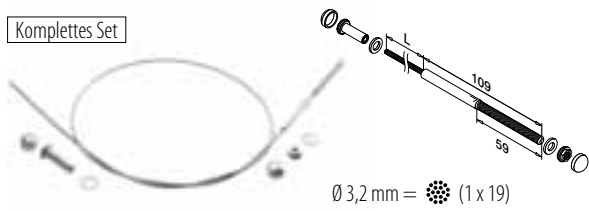

Ø 3,2 mm = (1 x 19)

#### MOD 7901

V4A	316	Gebürstet	OUTDOOR	Kabel Ø	
147901-003-01	3,2	L = 1 m			
147901-003-02	3,2	L = 2,5 m			
147901-003-05	3,2	L = 5 m			
147901-003-07	3,2	L = 7,5 m			
147901-003-10	3,2	L = 10 m			
147901-003-12	3,2	L = 12,5 m			
147901-003-20	3,2	L = 20 m			

Füllungen

### Endkappen

Für MOD 7240

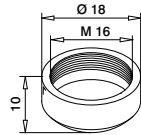

#### MOD 7245

V4A	316	Gebürstet	OUTDOOR	
147245				8

Füllungen

### Entriegelungswerkzeug



#### MOD 7802

V4A	316	Gebürstet	OUTDOOR	Für Kabel Ø	
207802-003				3,2	1

Füllungen

### Adapter

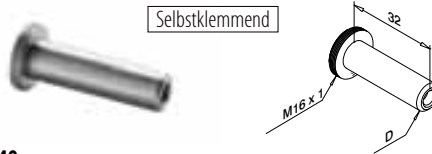

#### MOD 7240

V4A	316	Gebürstet	OUTDOOR	Für Kabel Ø	D	
147240-003				3,2	9,3	2

Internationaler Geschmacksmusterschutz

Füllungen

### Drahtseilstopper

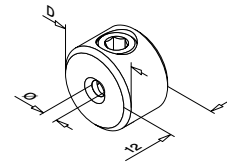

#### MOD 7400

V4A	316	Gebürstet	OUTDOOR	Für Kabel Ø	D	
147400-003				3,2 - 4,0	18	6



#### Q-INFO MOD 7400

Bitte benutzen Sie immer einen Drahtseilstopper, um die Kräfte auf den nächsten Geländerpfosten zu übertragen!

#### Q-INFO MOD 7901-003

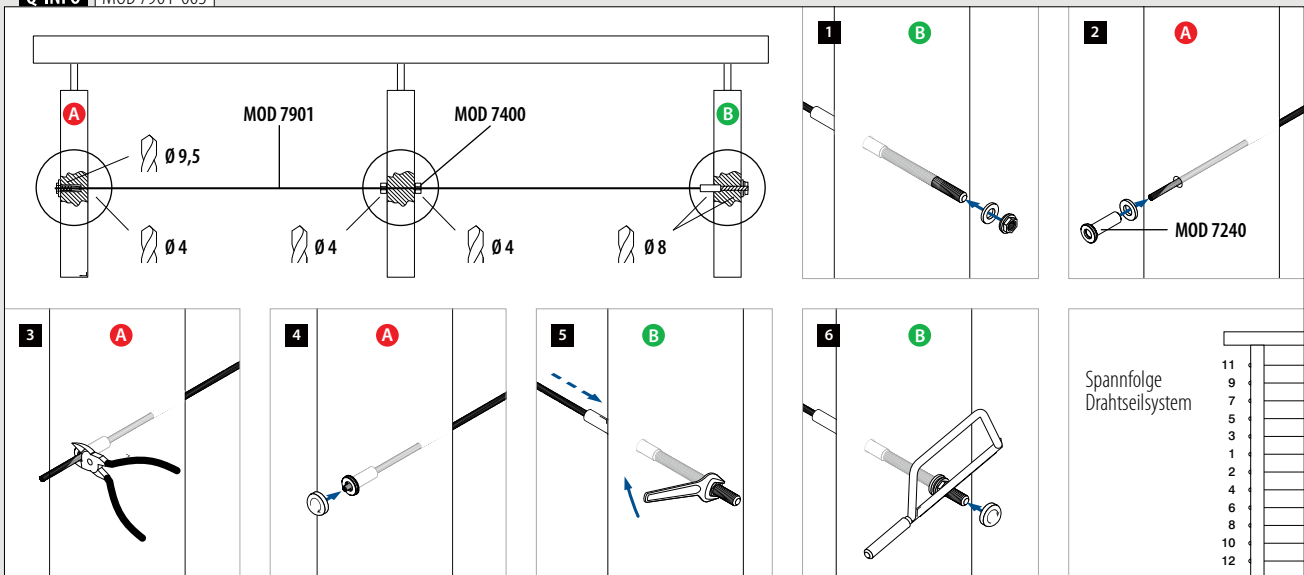

Füllungen

Drahtseilsystem, 4,0 mm

Komplettes Set

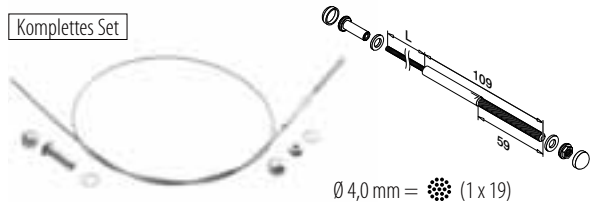

Ø 4,0 mm = (1 x 19)

MOD 7901

V4A	316	Gebürstet	OUTDOOR	Kabel Ø	
147901-004-01				4,0	L = 1 m
147901-004-02				4,0	L = 2,5 m
147901-004-05				4,0	L = 5 m
147901-004-07				4,0	L = 7,5 m
147901-004-10				4,0	L = 10 m
147901-004-12				4,0	L = 12,5 m
147901-004-20				4,0	L = 20 m

Füllungen

Endkappen

Für MOD 7240

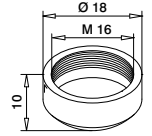

MOD 7245

V4A	316	Gebürstet	OUTDOOR	
147245				8

Füllungen

Entriegelungswerkzeug



MOD 7802

V4A	316	Gebürstet	OUTDOOR	Für Kabel Ø	
207802-004				4,0	1

Füllungen

Adapter



Selbstklemmend

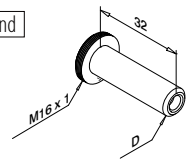

MOD 7240

V4A	316	Gebürstet	OUTDOOR	Für Kabel Ø	D	
147240-004				4,0	11,3	2

Internationaler Geschmacksmusterschutz

Füllungen

Drahtseilstopper

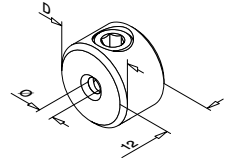

MOD 7400

V4A	316	Gebürstet	OUTDOOR	Für Kabel Ø	D	
147400-003				3,2 - 4,0	18	6



Q-INFO MOD 7400 / 7401

Bitte benutzen Sie immer einen Drahtseilstopper, um die Kräfte auf den nächsten Geländerpfeiler zu übertragen!

Q-INFO MOD 7901-004

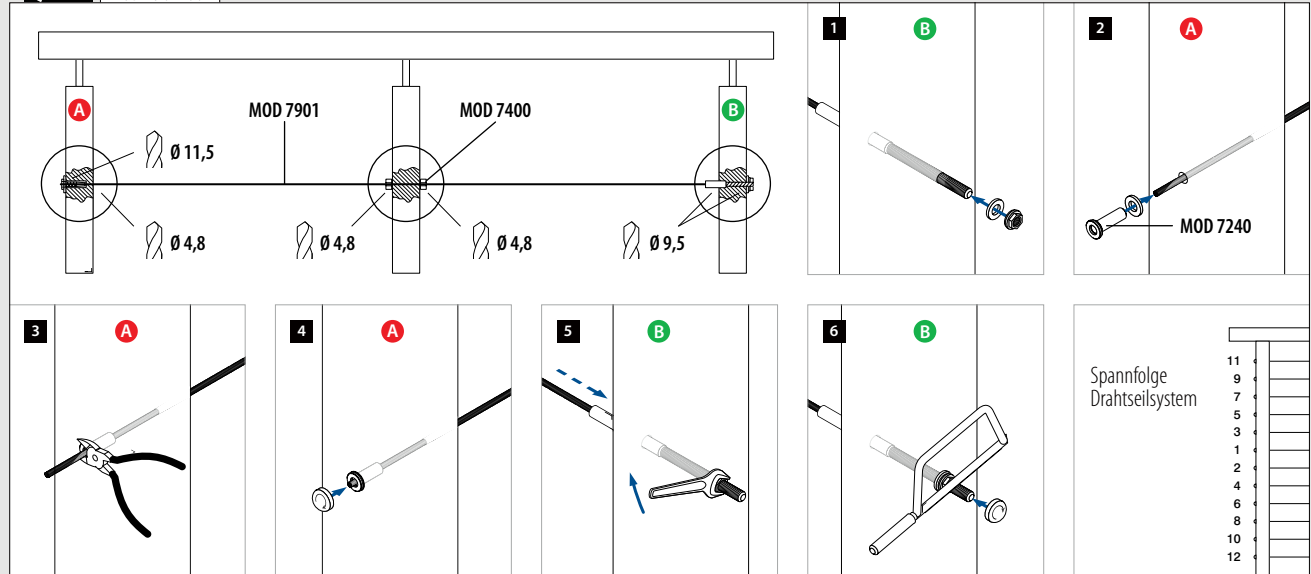

Drahtseilstopper zur diagonalen Montage

Für flaches Rohr

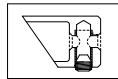
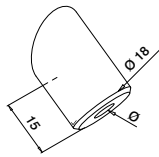

Abwärts  
+/- 35°

MOD 7401

V2A	304	Gebürstet		
	<b>INDOOR</b>		<b>Für Kabel Ø</b>	
	137401-000-02		3,2 - 4,0	6
V4A	316	Gebürstet		
	<b>OUTDOOR</b>			
	147401-000-02		3,2 - 4,0	6



Für rundes Rohr

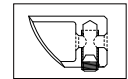
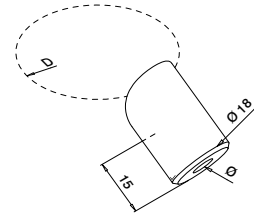

Abwärts  
+/- 35°

MOD 7401

V2A	304	Gebürstet		
	<b>INDOOR</b>		<b>D</b>	<b>Für Kabel Ø</b>
	137401-042-02		42,4	3,2 - 4,0
V4A	316	Gebürstet		
	<b>OUTDOOR</b>			
	147401-042-02		42,4	3,2 - 4,0



Für flaches Rohr

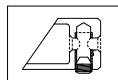
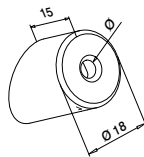

Aufwärts  
+/- 35°

MOD 7401

V2A	304	Gebürstet		
	<b>INDOOR</b>		<b>Für Kabel Ø</b>	
	137401-000-01		3,2 - 4,0	6
V4A	316	Gebürstet		
	<b>OUTDOOR</b>			
	147401-000-01		3,2 - 4,0	6



Für rundes Rohr

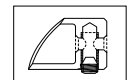
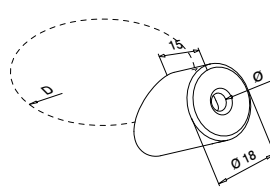

Aufwärts  
+/- 35°

MOD 7401

V2A	304	Gebürstet		
	<b>INDOOR</b>		<b>D</b>	<b>Für Kabel Ø</b>
	137401-042-01		42,4	3,2 - 4,0
V4A	316	Gebürstet		
	<b>OUTDOOR</b>			
	147401-042-01		42,4	3,2 - 4,0



Adapter zur diagonalen Installation

Für flaches Rohr

Oben und unten

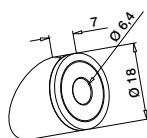

+/- 35°

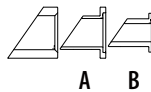

MOD 7403

V2A	304	Gebürstet		
	<b>INDOOR</b>		<b>Für Kabel Ø</b>	
	137403-000		3,2 - 4,0	6
V4A	316	Gebürstet		
	<b>OUTDOOR</b>			
	147403-000		3,2 - 4,0	6

Internationaler Geschmacksmusterschutz

Für rundes Rohr

Oben und unten

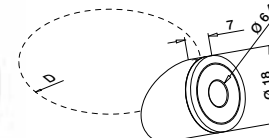

+/- 35°

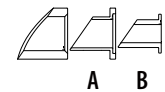

MOD 7403

V2A	304	Gebürstet		
	<b>INDOOR</b>		<b>D</b>	<b>Für Kabel Ø</b>
	137403-042		42,4	3,2 - 4,0
V4A	316	Gebürstet		
	<b>OUTDOOR</b>			
	147403-042		42,4	3,2 - 4,0

Internationaler Geschmacksmusterschutz

Q-INFO MOD 7403

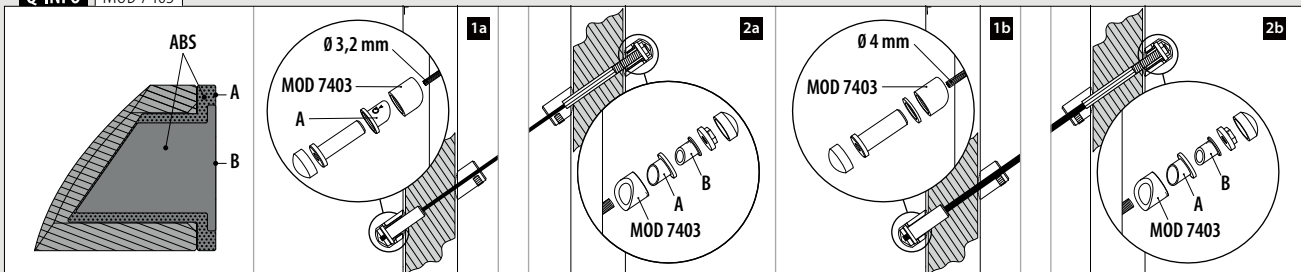



Füllungen

**Spanner**

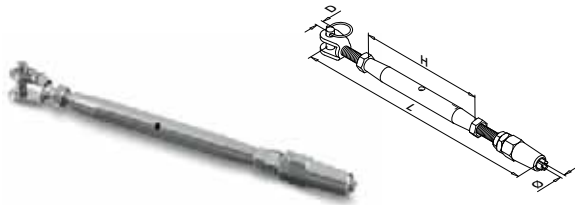

**MOD 7250**

V2A	304	Gebürstet	INDOOR	Für Kabel Ø	D	H	L	
			137250-003	3,2	5	90	155 - 230	2
			137250-006	6,0	9	125	270 - 325	2
V4A	316	Gebürstet	OUTDOOR					
			147250-003	3,2	5	90	155 - 230	2
			147250-006	6,0	9	125	270 - 325	2



Füllungen

**Drahtseil**

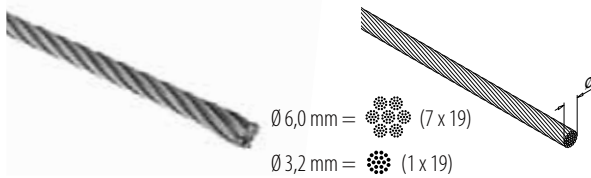

**MOD 7900**

V2A	304	Gebürstet	INDOOR	Ø	L
			137900-003-10	3,2	L = 10 m
			137900-003-50	3,2	L = 50 m
			137900-003-01	3,2	L = 100 m
SELL OUT			137900-006-10	6,0	L = 10 m
SELL OUT			137900-006-50	6,0	L = 50 m
			137900-006-01	6,0	L = 100 m
V4A	316	Gebürstet	OUTDOOR		
			147900-003-10	3,2	L = 10 m
			147900-003-50	3,2	L = 50 m
			147900-003-01	3,2	L = 100 m
			147900-006-10	6,0	L = 10 m
			147900-006-50	6,0	L = 50 m
			147900-006-01	6,0	L = 100 m

SELL OUT Nur solange der Vorrat reicht.

**Q-INFO** | MOD 7400

Bitte benutzen Sie immer einen Drahtseilstopper, um die Kräfte auf den nächsten Geländerpfosten zu übertragen!

**Q-INFO** | MOD 7900-006

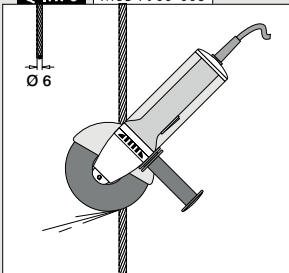

**Q-INFO**

Drahtseil-Schere



**MOD 7800**  
487

Füllungen

**Endstück**



**MOD 7300**

V2A	304	Gebürstet	INDOOR	Für Kabel Ø	D	L	
			137300-003	3,2	5	50	2
			137300-006	6,0	9	97	2
V4A	316	Gebürstet	OUTDOOR				
			147300-003	3,2	5	50	2
			147300-006	6,0	9	97	2



Füllungen

**Augenschrauben**

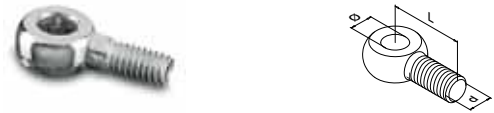

**MOD 7350**

V2A	304	Gebürstet	INDOOR	d	Ø	Für Kabel Ø	L	
			137350-619	M6	6	3,2	19	10
			137350-130	M10	9	6,0	30	10
V4A	316	Gebürstet	OUTDOOR					
			147350-619	M6	6	3,2	19	10
			147350-130	M10	9	6,0	30	10

Füllungen

**Drahtseilstopper**

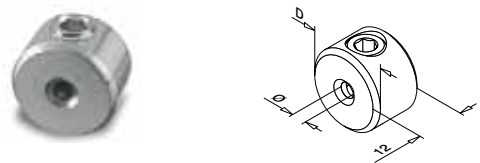

**MOD 7400**

V2A	304	Gebürstet	INDOOR	Für Kabel Ø	D	
			137400-003	3,2	18	6
			137400-006	6,0	20	6
V4A	316	Gebürstet	OUTDOOR			
			147400-003	3,2	18	6
			147400-006	6,0	20	6



Q-INFO

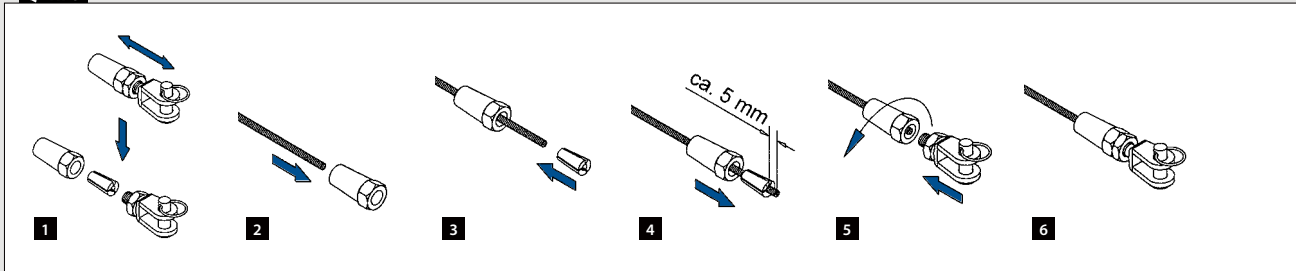

Q-INFO

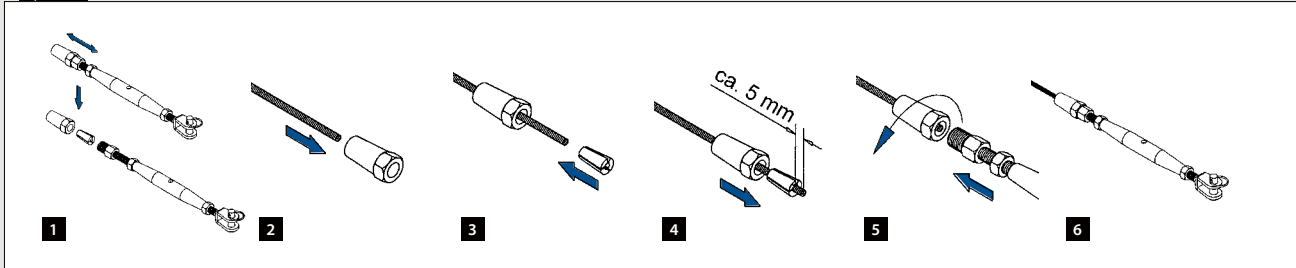

Q-INFO

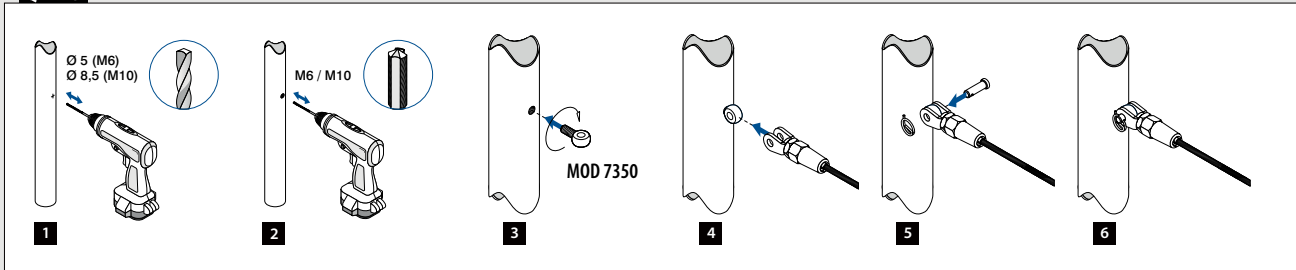

Q-INFO

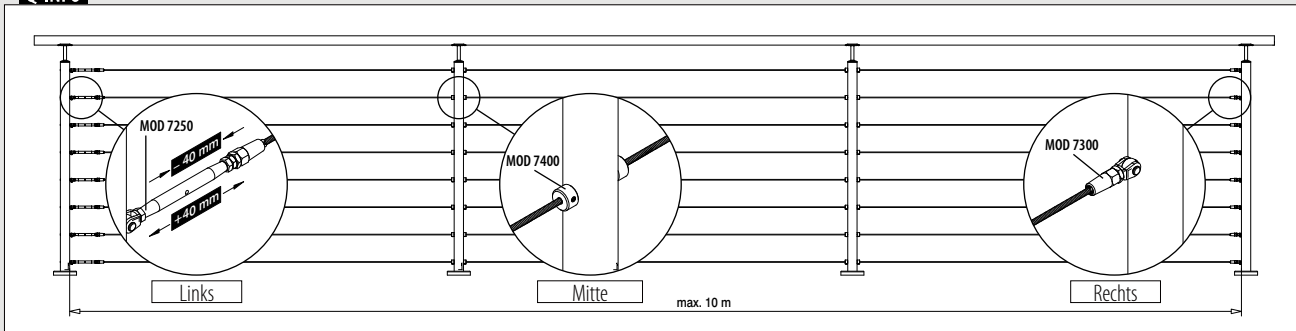

Drahtseilstopper zur diagonalen Montage

Für flaches Rohr

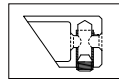
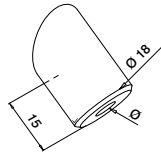

Abwärts  
+/- 35°

MOD 7401

V2A	304	Gebürstet		
INDOOR		Für Kabel Ø		
137401-000-02	3,2	6		
V4A	316	Gebürstet		
OUTDOOR		Für Kabel Ø		
147401-000-02	3,2	6		



Für rundes Rohr

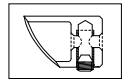
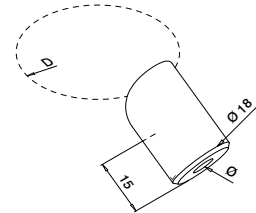

Abwärts  
+/- 35°

MOD 7401

V2A	304	Gebürstet		
INDOOR		D	Für Kabel Ø	
137401-042-02	42,4	3,2	6	
V4A	316	Gebürstet		
OUTDOOR		D	Für Kabel Ø	
147401-042-02	42,4	3,2	6	



Für flaches Rohr

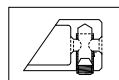
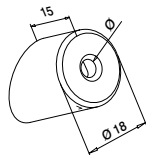

Aufwärts  
+/- 35°

MOD 7401

V2A	304	Gebürstet		
INDOOR		Für Kabel Ø		
137401-000-01	3,2	6		
V4A	316	Gebürstet		
OUTDOOR		Für Kabel Ø		
147401-000-01	3,2	6		



Für rundes Rohr

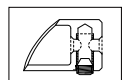
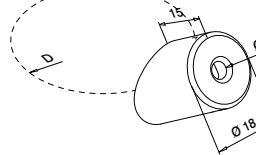

Aufwärts  
+/- 35°

MOD 7401

V2A	304	Gebürstet		
INDOOR		D	Für Kabel Ø	
137401-042-01	42,4	3,2	6	
V4A	316	Gebürstet		
OUTDOOR		D	Für Kabel Ø	
147401-042-01	42,4	3,2	6	



Q-INFO | MOD 7250 / 7401-042 / 7300

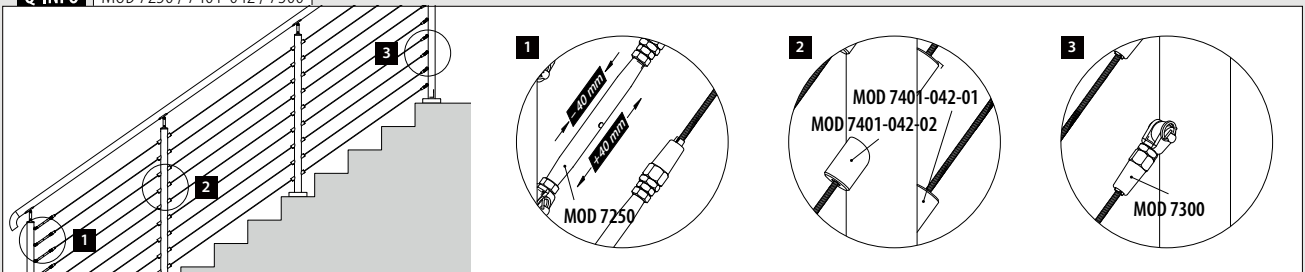

**Drahtseilhalter**

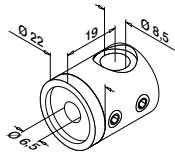

Für flaches Rohr  
Links

**MOD 7450**

V2A	<b>304</b>	Gebürstet		
<b>INDOOR</b>				
137450-000-01	QS-15	474		4

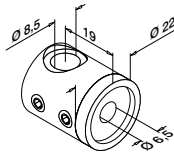

Für flaches Rohr  
Rechts

**MOD 7450**

V2A	<b>304</b>	Gebürstet		
<b>INDOOR</b>				
137450-000-02	QS-15	474		4

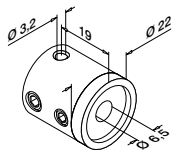

Für flaches Rohr  
Mitte

**MOD 7450**

V2A	<b>304</b>	Gebürstet		
<b>INDOOR</b>				
137450-000-00	QS-15	474		4

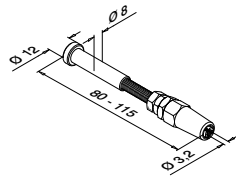

**MOD 7500**

V2A	<b>304</b>	Gebürstet		
<b>INDOOR</b>				
137500				4

V4A	<b>316</b>	Gebürstet		
<b>OUTDOOR</b>				
147500				4

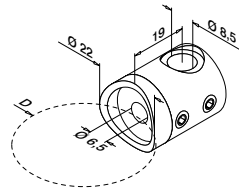

Für rundes Rohr  
Links

**MOD 7450**

V2A	<b>304</b>	Gebürstet		
<b>INDOOR</b>				
137450-042-01	D		QS-15	474
	42,4			4

V4A	<b>316</b>	Gebürstet		
<b>OUTDOOR</b>				
147450-042-01	D		QS-16	474
	42,4			4

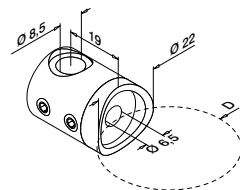

Für rundes Rohr  
Rechts

**MOD 7450**

V2A	<b>304</b>	Gebürstet		
<b>INDOOR</b>				
137450-042-02	D		QS-15	474
	42,4			4

V4A	<b>316</b>	Gebürstet		
<b>OUTDOOR</b>				
147450-042-02	D		QS-16	474
	42,4			4

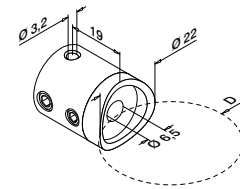

Für rundes Rohr  
Mitte

**MOD 7450**

V2A	<b>304</b>	Gebürstet		
<b>INDOOR</b>				
137450-042-00	D		QS-15	474
	42,4			4

V4A	<b>316</b>	Gebürstet		
<b>OUTDOOR</b>				
147450-042-00	D		QS-16	474
	42,4			4



**Q-INFO** | MOD 7450 / 7500 / 7900

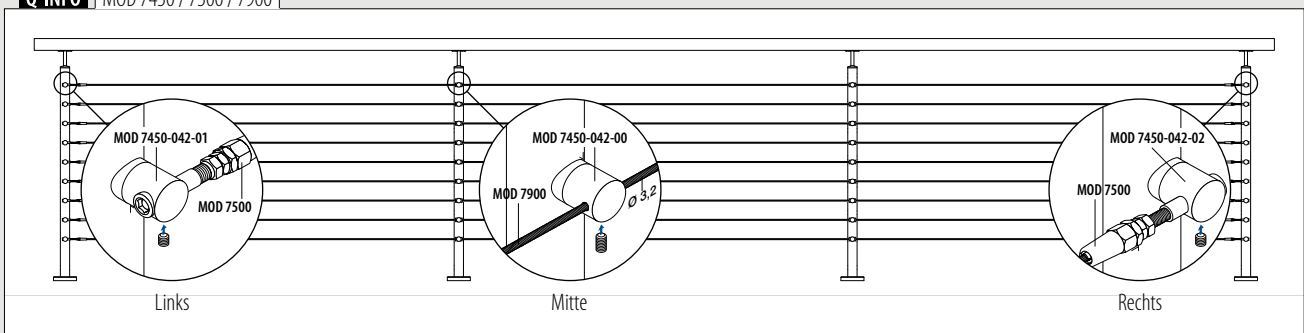



Finden Sie alle  
Informationen zu  
Netzfüllungen online:



<https://q-ne.ws/QWeb23>

# FÜLLUNGEN - NETZ

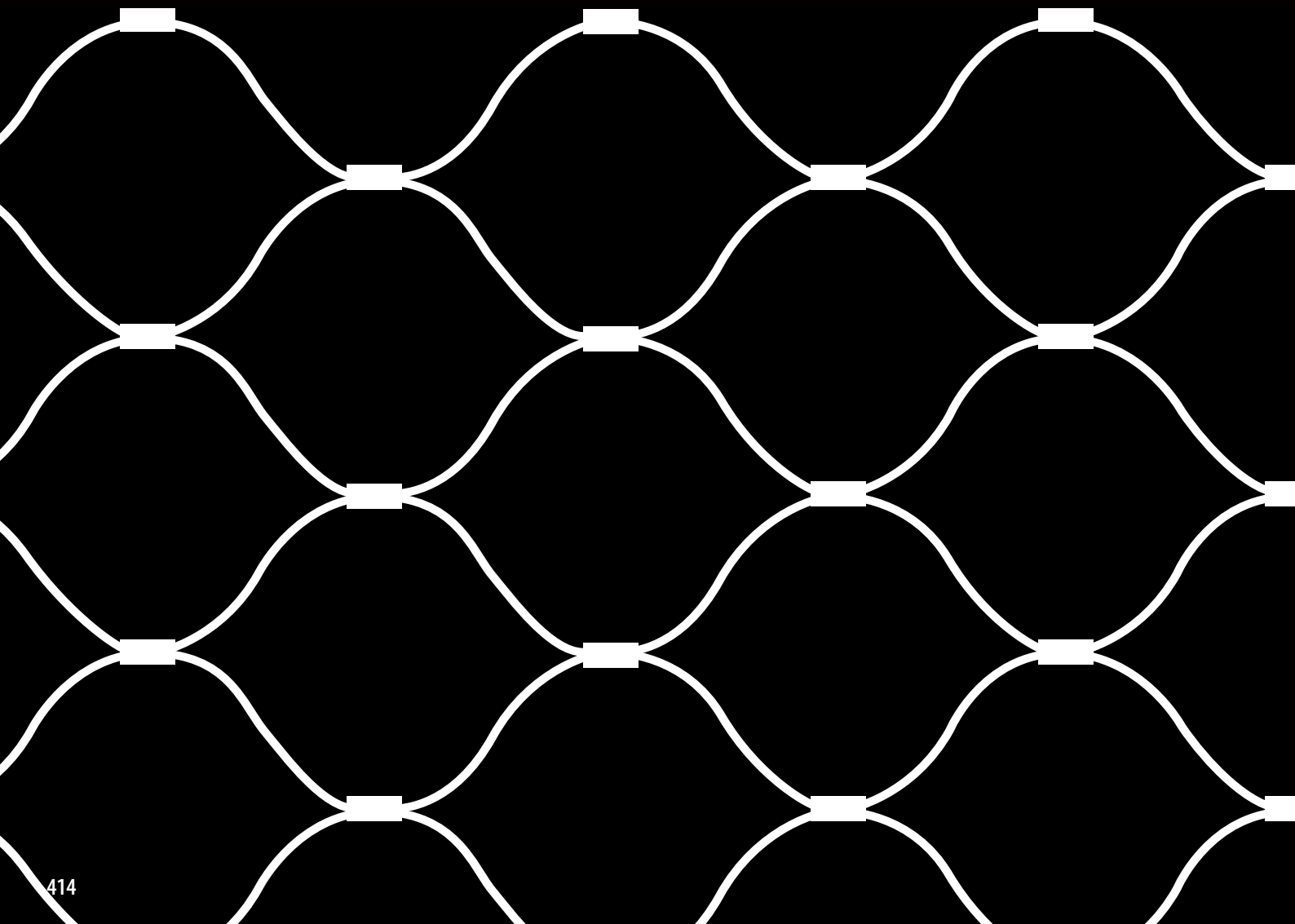



Füllungen

### Drahtseil



#### MOD 7900

V4A	316	Gebürstet	OUTDOOR	Ø	
147900-006-10	6,0				L = 10 m
147900-006-50	6,0				L = 50 m
147900-006-01	6,0				L = 100 m

Füllungen

### Drahtseilspanner



#### MOD 7260

V4A	316	Gebürstet	OUTDOOR	Ø	H	L	
147260-006	6			6	125	340-360	2

Füllungen

### Adapter

Für flaches Rohr



#### MOD 7723

V4A	316	Gebürstet	OUTDOOR	
147723-000				12

Für rundes Rohr

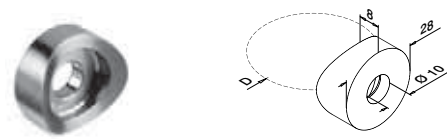

#### MOD 7723

V4A	316	Gebürstet	OUTDOOR	D	
147723-042				42,4	12
147723-048				48,3	12

Füllungen

### Drahtseilhalter

Für rundes Rohr

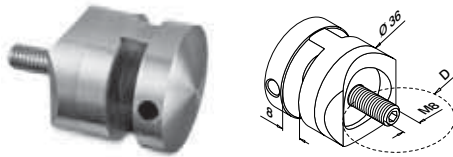

#### MOD 7356

V4A	316	Gebürstet	OUTDOOR	D	
147356-042				42,4	2



Füllungen

### Augenschrauben

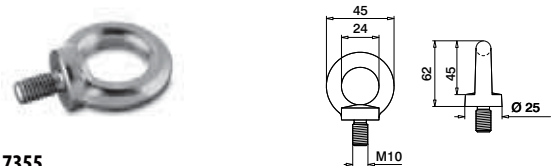

#### MOD 7355

V4A	316	Gebürstet	OUTDOOR	
147355-010				12

Zubehör

### Kabelbinder



#### MOD 1050

Zubehör	Q	L	
201050	Q-50	300	100

Q-INFO MOD 7900-006

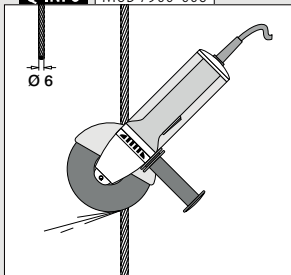

Q-INFO MOD 7356-042

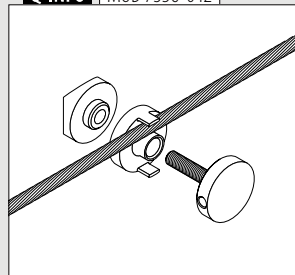

Q-INFO MOD 7355 / 7723

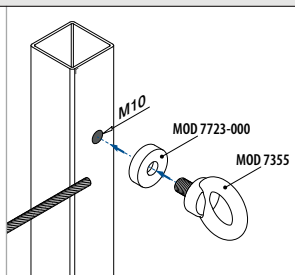
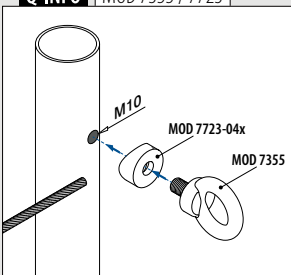

Füllungen

### Netze / Q-web

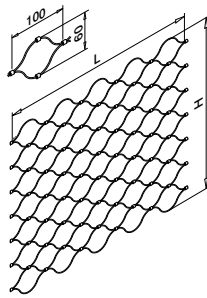
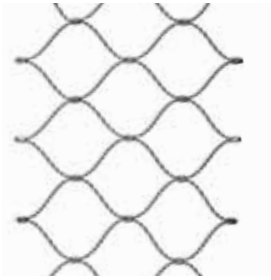

#### MOD 7910

V4A	316	Gebürstet		
OUTDOOR			H	
147910-050-06	600		L = 5 m	
147910-100-06	600		L = 10 m	
147910-500-06	600		L = 50 m	
147910-050-08	800		L = 5 m	
147910-100-08	800		L = 10 m	
147910-500-08	800		L = 50 m	

Füllungen

### Drahtseil

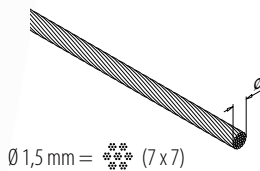

#### MOD 7911

V4A	316	Gebürstet		
OUTDOOR			Ø	
147911-100	1,5		L = 10 m	
147911-500	1,5		L = 50 m	
147911-001	1,5		L = 100 m	

Füllungen

### Netzverbinder

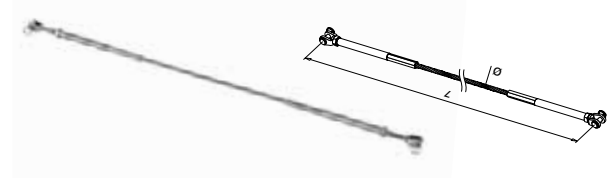

#### MOD 7780

V4A	316	Gebürstet		
OUTDOOR			Ø	L
147780	8		800	1

Füllungen

### Schräglemme

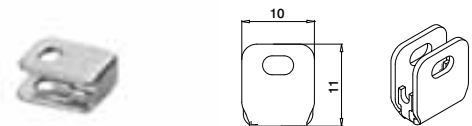

#### MOD 7810

V4A	316	Gebürstet		
OUTDOOR				
147810			12	

Füllungen

### Vertikalklemme



#### MOD 7820

V4A	316	Gebürstet		
OUTDOOR				
147820			12	

Internationaler Geschmacksmusterschutz

Füllungen

### Verbinder



#### MOD 7830

V4A	316	Gebürstet		
OUTDOOR				
147830			12	

#### Q-INFO | MOD 7260 / 7810 / 7820

##### Benötigte Menge

MOD 7260		1x pro 10 Meter
MOD 7810		20 Stück pro Meter (10x oben und 10x unten)
MOD 7820	H = 600 mm	10 Stück jede Seite (links und rechts)
	H = 800 mm	13 Stück jede Seite (links und rechts)









Finden Sie alle  
Informationen zu  
Blechfüllungen online:

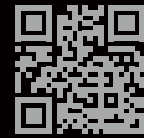

[q-ne.ws/lnfills23](http://q-ne.ws/lnfills23)

# PRODUKTE FÜR FÜLLUNGEN - BLECH

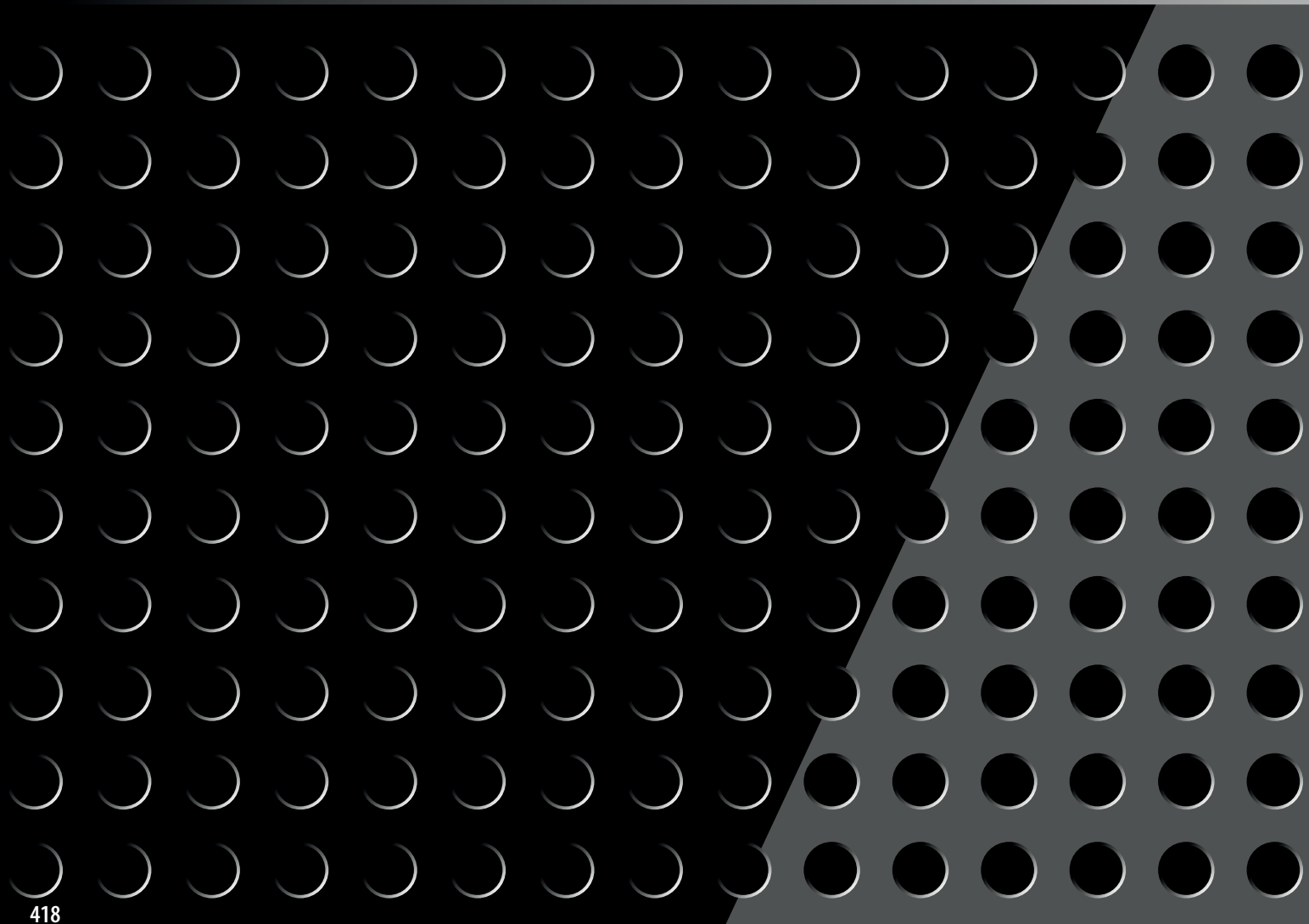

**Blechadapter - MOD 2800**

Für flaches Rohr

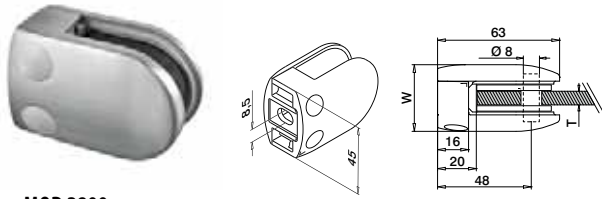

**MOD 2800**

V2A	304	Gebürstet				
INDOOR			W	T		
	132800-000-12		34	Siehe MOD 5028	QS-26	476 4
V2A	304	Hochglanzpoliert				
INDOOR						
SELL OUT	132800-000-10		34	Siehe MOD 5028	QS-26	476 4
V4A	316	Gebürstet				
OUTDOOR						
	142800-000-12		34	Siehe MOD 5028	QS-27	476 4
V4A	316	Hochglanzpoliert				
OUTDOOR						
	142800-000-10		34	Siehe MOD 5028	QS-27	476 4
V4A	316	Black Line				
OUTDOOR						
NEW	142800-000-82		34	Siehe MOD 5028	QS-27	476 4
Zinkdruckguss						
INDOOR						
SELL OUT	102800-000-...		36	Siehe MOD 5028	QS-28	476 4



Internationaler Geschmacksmusterschutz

Für rundes Rohr

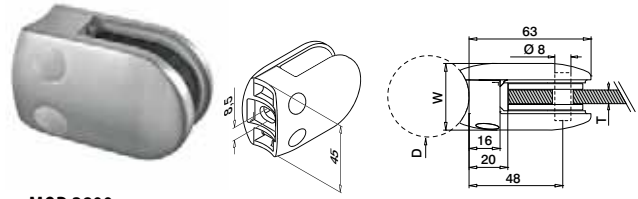

**MOD 2800**

V2A	304	Gebürstet					
INDOOR			D	W	T		
	132800-042-12		42,4	34	Siehe MOD 5028	QS-47	476 4
	132800-048-12		48,3	34	Siehe MOD 5028	QS-47	476 4
V2A	304	Hochglanzpoliert					
INDOOR							
SELL OUT	132800-042-10		42,4	34	Siehe MOD 5028	QS-47	476 4
SELL OUT	132800-048-10		48,3	34	Siehe MOD 5028	QS-47	476 4
V4A	316	Gebürstet					
OUTDOOR							
	142800-042-12		42,4	34	Siehe MOD 5028	QS-45	476 4
	142800-048-12		48,3	34	Siehe MOD 5028	QS-45	476 4
V4A	316	Hochglanzpoliert					
OUTDOOR							
NEW	142800-042-10		42,4	34	Siehe MOD 5028	QS-45	476 4
NEW	142800-048-10		42,4	34	Siehe MOD 5028	QS-45	476 4
Zinkdruckguss							
INDOOR							
SELL OUT	102800-042-...		42,4	36	Siehe MOD 5028	QS-46	476 4
SELL OUT	102800-048-...		48,3	36	Siehe MOD 5028	QS-46	476 4



Internationaler Geschmacksmusterschutz

**Gummieinlagen für Blechadapter MOD 2800**



2 Stück pro Blechadapter

**MOD 5028**

**Zubehör**

	T	
205028-02	2	8
205028-03	3	8
205028-04	4	8

SELL OUT Nur solange der Vorrat reicht.

Bitte bestellen Sie Befestigungsmaterial separat.

**Q-INFO MOD 5015 / 2800**

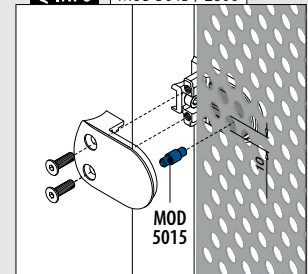

**Q-INFO 304 316 MOD 2800 Oberflächen**

<b>10</b>	<b>12</b>	<b>82 RAL 9005</b> Pulver- beschichtet
Hochglanz- poliert	Gebürstet	Schwarz, matt, strukturiert

**Q-INFO Zinkdruckguss MOD 2800 Oberflächen**

<b>00</b>	<b>17</b>	<b>19</b>	<b>82 RAL 9005</b> Pulver- beschichtet	<b>89 RAL 9005</b> Pulver- beschichtet INDOOR
Roh	Glanzverchromt	Edelstahleffekt	Schwarz, matt, strukturiert	Schwarz, matt, glatt
	102800-000-00	102800-000-17	102800-000-19	102800-000-82
	102800-04x-00	102800-04x-19	102800-04x-82	102800-04x-89

**Q-INFO**

**00**

Artikel mit .00-Ausführung können pulverbeschichtet werden.



**Blechadapter - MOD 4200**

Für flaches Rohr

Inklusive Sicherungsplatte

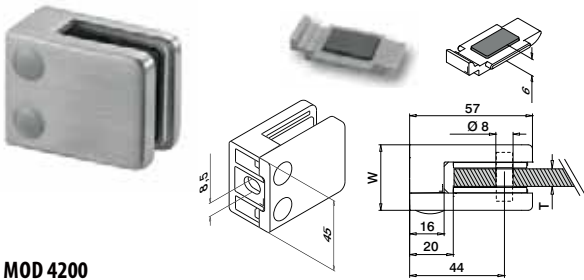

Für rundes Rohr

Inklusive Sicherungsplatte

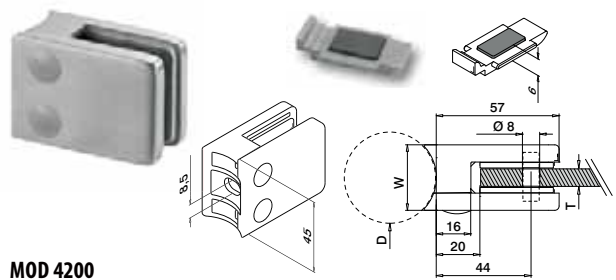

**MOD 4200**

V2A	304	Gebürstet				
INDOOR		W	T			
	134200-000-12	28	Siehe MOD 5042	QS-26		476 4
V4A	316	Gebürstet				
OUTDOOR						
	144200-000-12	28	Siehe MOD 5042	QS-27		476 4
V4A	316	Black Line				
OUTDOOR						
<b>NEW</b>	144200-000-82	28	Siehe MOD 5042	QS-27		476 4
V4A	316	Hochglanzpoliert				
OUTDOOR						
	144200-000-10	28	Siehe MOD 5042	QS-27		476 4
Zinkdruckguss						
INDOOR						
<b>SELL OUT</b>	104200-000-...	30	Siehe MOD 5042	QS-28		476 4



Internationaler Geschmacksmusterschutz

**MOD 4200**

V2A	304	Gebürstet					
INDOOR		D	W	T			
	134200-042-12	42,4	28	Siehe MOD 5042	QS-47		476 4
	134200-048-12	48,3	28	Siehe MOD 5042	QS-47		476 4
V2A	304	Black Line					
INDOOR							
<b>NEW</b>	134200-042-82	42,4	28	Siehe MOD 5042	QS-47		476 4
V4A	316	Gebürstet					
OUTDOOR							
	144200-042-12	42,4	28	Siehe MOD 5042	QS-45		476 4
	144200-048-12	48,3	28	Siehe MOD 5042	QS-45		476 4
V4A	316	Hochglanzpoliert					
OUTDOOR							
	144200-042-10	42,4	28	Siehe MOD 5042	QS-45		476 4
	144200-048-10	48,3	28	Siehe MOD 5042	QS-45		476 4
Zinkdruckguss							
INDOOR							
<b>SELL OUT</b>	104200-042-...	42,4	30	Siehe MOD 5042	QS-46		476 4
<b>SELL OUT</b>	104200-048-...	48,3	30	Siehe MOD 5042	QS-46		476 4



Internationaler Geschmacksmusterschutz

**Q-INFO** 304 316 MOD 4200 Oberflächen

10



Hochglanzpoliert

12

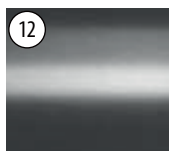

Gebürstet

82 RAL 9005



Schwarz, matt, strukturiert

**Q-INFO**

00



Artikel mit .00-Ausführung können pulverbeschichtet werden.

**Q-INFO** MOD 5015 / 4200

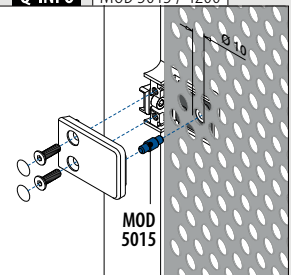

**Q-INFO** Zinkdruckguss MOD 4200 Oberflächen

00



Roh

17



Glanzverchromt

19



Edelfstahleffekt

32 RAL 9016



Weiß, satiniert, glatt

33 RAL 7016



Anthrazitgrau, matt, strukturiert

36 RAL 9006



Weißaluminium, satiniert, glatt

82 RAL 9005



Schwarz, matt, strukturiert

89 RAL 9005



Schwarz, matt, glatt



104200-000-00

104200-000-17

104200-000-19

104200-000-32

104200-000-33

104200-000-36

104200-000-82

104200-000-89



104200-04x-00

104200-04x-19

104200-042-82

104200-042-89

Gummieinlagen für Blechadapter MOD 4200



2 Stück pro Blechadapter

MOD 5042

Zubehör		
	T	
205042-02	2	8
205042-03	3	8
205042-04	4	8

Sicherungsstifte

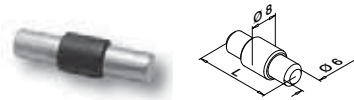

Optional verwendbar für MOD 4200

MOD 5015

Zubehör		
	L	
205015-22	22	4

Blechadapter - MOD 0743

Für flaches Rohr

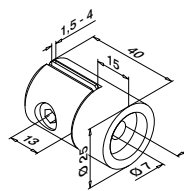

MOD 0743

V2A	304	Gebürstet		
INDOOR				
130743-000	QS-17	474		4



Für rundes Rohr

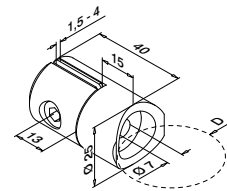

MOD 0743

V2A	304	Gebürstet		
INDOOR				
	D			
130743-042	42,4	QS-17	474	4
130743-048	48,3	QS-17	474	4





# 5

# GLAS- BEFESTI- GUNGEN

Finden Sie Ihre Glasbefestigung ..... 425 - 432

Glasklemmen ..... 432 - 444

Glashalter ..... 446 - 447

Glasverbinder ..... 448 - 450

Scharniere und Türriegel ..... 450 - 451

Glasadapter ..... 453 - 455





## GLAS- HALTER

▣ 446 - 447



Finden Sie alle  
Informationen zu  
Glasklemmen online:



[https://q-ne.ws/  
GlassClamps23](https://q-ne.ws/GlassClamps23)

## GLAS- KLEMMEN

▣ 432 - 444



## GLAS- VERBINDER

▣ 448 - 450

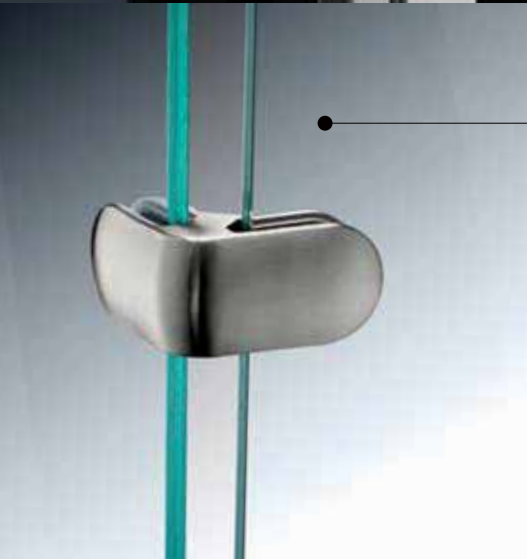

## GLAS- ADAPTER

▣ 453 - 455



## SCHARNIERE UND TÜRRIEGEL

▣ 450 - 451



# GLASKLAR UND ABSOLUT SICHER

Glas wird oft als zerbrechliches Material angesehen, dabei ist es erstaunlich widerstandsfähig. Dies macht es zu einer hervorragenden Geländerfüllung. Kombinieren Sie es mit Q-railings starken Glashaltern und erhalten Sie ein äußerst robustes Geländer. Wir wissen das aus der Praxis: In unserem hauseigenen Prüflabor unterziehen wir unsere Produkte laufend strengen Tests. Außerdem werden umfangreiche Prüfungen von zertifizierten unabhängigen Testinstituten und führenden Behörden durchgeführt.

Das Ergebnis: Unsere gemäß der internationalen Norm EN-12600 getesteten Glasklemmen halten dynamischen Belastungen von bis zu 50 kg stand – unabhängig davon, ob Sie gehärtetes Verbundglas oder monolithisches Glas (6 - 21,52 mm) wählen. Beide Varianten entsprechen den internationalen DIN- und BS-Normen und besitzen die allgemeine bauaufsichtliche Zulassung (AbZ).

## ZERTIFIZIERUNG

Unsere Glasklemmen sind nach DIN/EN 12600 getestet und haben daneben eine AbZ.

Die deutschen Indoor-Tests wurden von der Technischen Universität München, die Outdoor-Tests von dem anerkannten Ingenieurbüro Dr. Roland Ondra sowie der LGA Würzburg berechnet.

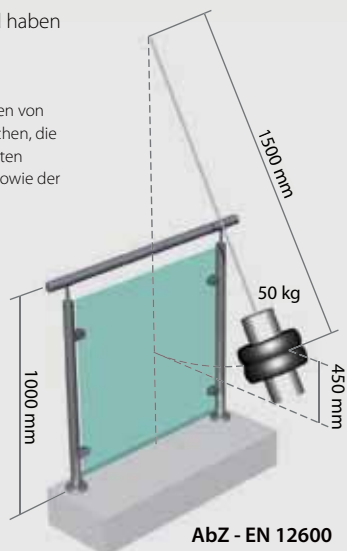

## SICHERHEIT

### Seitenmontage? Sicherheit geht vor!

Verwenden Sie Sicherungsstifte oder Sicherungsplatten.



(MOD 5015)



(Enthalten in MOD 2300, 2400, 2600, 4200)

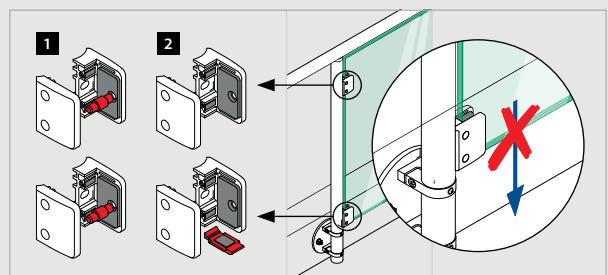

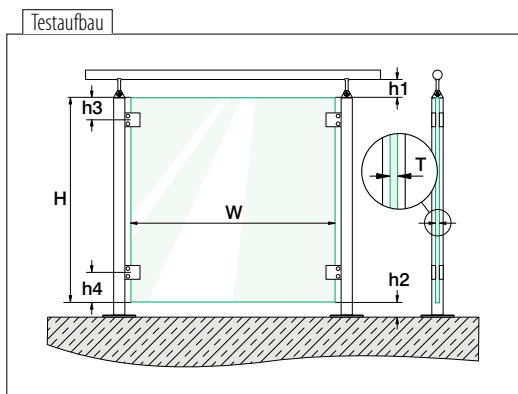

Abmessungen (mm)	min.	max.
W Glasbreite	500	Siehe entspr. Modell
T Glasstärke	Siehe entspr. Modell	Siehe entspr. Modell
H Glashöhe	800	1000
h1 Abstand Handlauf - Glas	10	50 ohne Kantenschutz / 120 mit Kantenschutz
h2 Abstand Boden - Glas	10	50 ohne Kantenschutz / 120 mit Kantenschutz
h3 Glaskante oben - Achse obere Glasklemme	100 : MOD 2500, 2100, 2600, 2400 50 : MOD 2800 120 : MOD 4200	150
h4 Glaskante unten - Achse untere Glasklemme	100 : MOD 2500, 2100, 2600, 2400 50 : MOD 2800 120 : MOD 4200	150

# INDOOR

Glasklemmen ohne Sicherungsstift und ohne Sicherungsplatte.

## MOD 2700

V2A 304 Zinkdruckguss



Flach oder Rohr  
Ø 33,7 mm  
Ø 42,4 mm

Glasart	Mono / ESG-H*		
T (mm)	8		
W <sub>max</sub> (mm)	1200		

## MOD 2500

V2A 304 Zinkdruckguss



Flach oder Rohr  
Ø 42,4 mm  
Ø 48,3 mm

Glasart	VSG / TVG*					VSG / ESG*					Mono / ESG-H*		
T (mm)	8,76	9,52	10,76	11,52	12,76	8,76	9,52	10,76	11,52	12,76	8	10	12
W <sub>max</sub> (mm)	1500	1500	1500	1500	1500	1500	1500	1500	1500	1500	1500	1500	1500

## MOD 2800

V2A 304 Zinkdruckguss



Flach oder Rohr  
Ø 48,3 mm

Glasart	VSG / SPG*	VSG / TVG*					VSG / ESG*					Mono / ESG-H*		
T (mm)	12,76	8,76	9,52	10,76	11,52	12,76	8,76	9,52	10,76	11,52	12,76	8	10	12
W <sub>max</sub> (mm)	1500	1800	1800	1800	1800	1800	1800	1800	1800	1800	2000	1800	1800	1800

## MOD 2100

V2A 304 Zinkdruckguss



Flach oder Rohr  
Ø 42,4 mm

Glasart	VSG / ESG*					
T (mm)	8,76			9,52		
W <sub>max</sub> (mm)	1200			1200		

## MOD 4200

V2A 304 Zinkdruckguss



Flach oder Rohr  
Ø 42,4 mm  
Ø 48,3 mm

Glasart	VSG / SPG*	VSG / TVG*				VSG / ESG*				Mono / ESG-H*		
T (mm)	12,76	10,76	11,52	12,76	8,76	9,52	10,76	11,52	12,76	8	10	12
W <sub>max</sub> (mm)	1600	1600	1600	1600	1800	1800	1800	1800	1800	1800 <sup>1</sup> 2000 <sup>2</sup>	1800	1800

<sup>1</sup> Zinkdruckguss <sup>2</sup> Edelstahl 304

## MOD 2600

V2A 304 Zinkdruckguss



Flach oder Rohr  
Ø 42,4 mm  
Ø 48,3 mm

Glasart	VSG / TVG*				VSG / ESG*				Mono / ESG-H*		
T (mm)	8,76	10,76	11,52	12,76	8,76	10,76	11,52	12,76	8	10	12
W <sub>max</sub> (mm)	1400	1600	1600	1600	1400	1600	1600	1600	1400	1600	1600

## MOD 2400

V2A 304 Zinkdruckguss



Flach oder Rohr  
Ø 48,3 mm

Glasart	VSG / SPG*				VSG / TVG*				VSG / ESG*				Mono / ESG-H*	
T (mm)	12,76	13,52	16,76	17,52	12,76	13,52	16,76	17,52	12,76	13,52	16,76	17,52	12	15
W <sub>max</sub> (mm)	1500	1500	1500	1500	1500	1500	1500	1500	1600	1600	1600	1600	1600	1600



# OUTDOOR

Mögliche Glasbreite für die Anwendung im Außenbereich abhängig von Windlast, Glastype und Glasstärke - ohne Sicherungsstift und ohne Sicherungsplatte.

## MOD 2500

V4A 316



Flach  
oder Rohr  
Ø 42,4 mm  
Ø 48,3 mm

Wind- druck	Glasant	VSG / TVG*		VSG / ESG*		Mono / ESG-H*	
	T (mm)	8,76	9,52	10,76	12,76	8	10
2,20 kN/m <sup>2</sup>	W <sub>max</sub> (mm)	-	-	-	-	800	800
1,60 kN/m <sup>2</sup>		-	-	500	500	1000	1400
1,40 kN/m <sup>2</sup>		-	-	500	500	1000	1400
1,04 kN/m <sup>2</sup>		500	500	800	800	1400	1500
1,00 kN/m <sup>2</sup>		500	500	1000	1000	1400	1500
0,64 kN/m <sup>2</sup>		800	800	1200	1200	1500	1500

## MOD 2800 / 4200

V4A 316



Flach  
oder Rohr  
Ø 42,4 mm  
Ø 48,3 mm

Flach  
oder Rohr  
Ø 42,4 mm  
Ø 48,3 mm

Wind- druck	Glasant	VSG / SPG*			VSG / TVG*			VSG / ESG*			Mono / ESG-H*				
	T (mm)	12,76	8,76	9,52	10,76	11,52	12,76	8,76	9,52	10,76	11,52	12,76	8	10	12
2,20 kN/m <sup>2</sup>	W <sub>max</sub> (mm)	-	-	-	700	700	950	650	650	950	950	1100	1000	1500	1700
2,00 kN/m <sup>2</sup>		-	-	-	700	700	1000	700	700	1000	1000	1200	1050	1600	1800
1,60 kN/m <sup>2</sup>		-	-	-	800	800	1100	800	800	1100	1100	1200	1200	1600	1800
1,40 kN/m <sup>2</sup>		-	600	600	900	900	1300	850	850	1200	1200	1400	1250	1600	1800
1,04 kN/m <sup>2</sup>		-	700	700	1050	1050	1300	1000	1000	1300	1300	1400	1500	1700	1800
1,00 kN/m <sup>2</sup>		-	700	700	1050	1050	1300	1000	1000	1300	1300	1400	1500	1700	1800
0,70 kN/m <sup>2</sup>		-	900	900	1050	1050	1400	1100	1100	1400	1400	1500	1550	1700	1800

## MOD 2600

V4A 316



Flach  
oder Rohr  
Ø 42,4 mm  
Ø 48,3 mm

Wind- druck	Glasant	VSG / TVG*				VSG / ESG*				Mono / ESG-H*		
	T (mm)	8,76	10,76	11,52	12,76	8,76	10,76	11,52	12,76	8	10	12
2,20 kN/m <sup>2</sup>	W <sub>max</sub> (mm)	-	-	-	500	500	800	800	800	800	1000	1400
1,60 kN/m <sup>2</sup>		-	500	500	800	800	800	800	1000	1000	1400	1400
1,40 kN/m <sup>2</sup>		-	800	800	800	800	1000	1000	1200	1200	1400	1400
1,04 kN/m <sup>2</sup>		500	800	800	1000	800	1000	1000	1400	1400	1400	1400
1,00 kN/m <sup>2</sup>		500	800	800	1000	800	1200	1200	1400	1400	1400	1400
0,64 kN/m <sup>2</sup>		800	1000	1000	1200	1200	1400	1400	1400	1400	1400	1400

## MOD 2400

V4A 316



Flach  
oder Rohr  
Ø 48,3 mm

Wind- druck	Glasant	VSG / SPG*				VSG / TVG*				VSG / ESG*				Mono / ESG-H*	
	T (mm)	12,76	13,52	16,76	17,52	12,76	13,52	16,76	17,52	12,76	13,52	16,76	17,52	12	16
2,20 kN/m <sup>2</sup>	W <sub>max</sub> (mm)	500	500	800	800	500	500	1000	1000	500	500	1000	1000	1400	1600
1,60 kN/m <sup>2</sup>		500	500	1000	1000	800	800	1200	1200	800	800	1200	1200	1500	1600
1,40 kN/m <sup>2</sup>		800	800	1000	1000	800	800	1200	1200	800	800	1400	1400	1600	1600
1,04 kN/m <sup>2</sup>		800	800	1200	1200	1000	1000	1500	1500	1200	1200	1600	1600	1600	1600
1,00 kN/m <sup>2</sup>		1000	1000	1200	1200	1000	1000	1500	1500	1200	1200	1600	1600	1600	1600
0,64 kN/m <sup>2</sup>		1200	1200	1500	1500	1500	1500	1500	1500	1500	1500	1600	1600	1600	1600

\* VSG: Verbundsicherheitsglas  
Mono: Monolithisches Glas

SPG: Spiegelglas  
TVG: Teilvorgespanntes Glas

ESG: Einscheibensicherheitsglas  
ESG-H: Einscheibensicherheitsglas - Heißlagerungstest

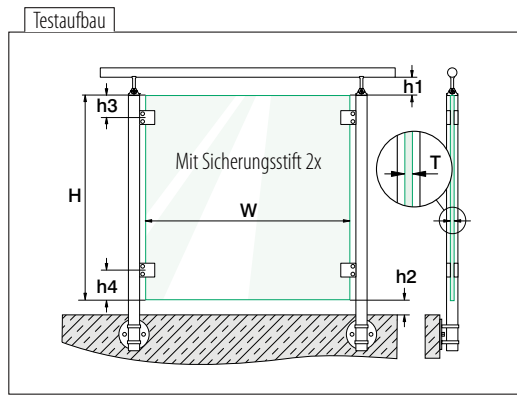

Abmessungen (mm)		min.	max.
W	Glasbreite	500	Siehe entspr. Modell
T	Glasstärke	Siehe entspr. Modell	Siehe entspr. Modell
H	Glashöhe	800	1000
h1	Abstand Handlauf - Glas	10	50 ohne Kantenschutz / 120 mit Kantenschutz
h2	Abstand Boden - Glas	10	50 ohne Kantenschutz / 120 mit Kantenschutz
h3	Glaskante oben - Achse obere Glasklemme	150 : MOD 2500 / MOD 2400 50 : MOD 2800 120 : MOD 4200	150
h4	Glaskante unten - Achse untere Glasklemme	150 : MOD 2500 / MOD 2400 50 : MOD 2800 120 : MOD 4200	150

# INDOOR



Glasklemmen mit Sicherungsstift, ohne Sicherungsplatte.

## MOD 2500

V2A 304 Zinkdruckguss



Flach oder Rohr  
Ø 42,4 mm  
Ø 48,3 mm

Glasart	VSG / ESG*
T (mm)	12,76
W <sub>max</sub> (mm)	1600

## MOD 2800

V2A 304 Zinkdruckguss



Flach oder Rohr  
Ø 42,4 mm  
Ø 48,3 mm

Glasart	VSG / TVG*					VSG / ESG*					Mono / ESG-H*			
	T (mm)	8,76	9,52	10,76	11,52	12,76	8,76	9,52	10,76	11,52	12,76	8	10	12
W <sub>max</sub> (mm)	1800	1800	1800	1800	1800	1800	1800	1800	1800	1800	1800	1800	1800	1800

## MOD 4200

V2A 304 Zinkdruckguss



Flach oder Rohr  
Ø 42,4 mm  
Ø 48,3 mm

Glasart	VSG / SPG*		VSG / TVG*			VSG / ESG*					Mono / ESG-H*				
	T (mm)	12,76	10,76	11,52	12,76	8,76	9,52	10,76	11,52	12,76	1800 <sup>1</sup>	2000 <sup>2</sup>	8	10	12
W <sub>max</sub> (mm)	1500	1600	1600	1600	1600	1800	1800	1800	1800	1800	1800	1800	1800	1800	1800

<sup>1</sup> Zinkdruckguss <sup>2</sup> Edelstahl 304

## MOD 2400

V2A 304 Zinkdruckguss



Flach oder Rohr  
Ø 42,4 mm  
Ø 48,3 mm

Glasart	VSG / ESG*				Mono / ESG-H*		
	T (mm)	12,76	13,52	16,76	17,52	12	15
W <sub>max</sub> (mm)	1600	1600	1600	1600	1600	1600	1600

\* VSG: Verbundsicherheitsglas  
Mono: Monolithisches Glas

SPG: Spiegelglas  
TVG: Teilvorgespanntes Glas

ESG: Einscheibensicherheitsglas  
ESG-H: Einscheibensicherheitsglas - Heißlagerungstest



# OUTDOOR



Mögliche Glasbreite für die Anwendung im Außenbereich abhängig von Windlast, Glastyp und Glasstärke - mit Sicherungsstift, ohne Sicherungsplatte.

## MOD 2500

V4A 316



Flach  
oder Rohr  
Ø 42,4 mm  
Ø 48,3 mm

Wind- druck	Glasart	VSG / ESG*	
	T (mm)	12,76	
2,20 kN/m <sup>2</sup>	W <sub>max</sub> (mm)	1100	
2,00 kN/m <sup>2</sup>		1200	
1,60 kN/m <sup>2</sup>		1200	
1,40 kN/m <sup>2</sup>		1400	
1,04 kN/m <sup>2</sup>		1400	
1,00 kN/m <sup>2</sup>		1400	
0,70 kN/m <sup>2</sup>		1500	

## MOD 2800 / 4200

V4A 316



Flach  
oder Rohr  
Ø 42,4 mm  
Ø 48,3 mm



Flach  
oder Rohr  
Ø 42,4 mm  
Ø 48,3 mm

Wind- druck	Glasart T (mm)	VSG / TVG*					VSG / ESG*					Mono / ESG-H*		
		8,76	9,52	10,76	11,52	12,76	8,76	9,52	10,76	11,52	12,76	8	10	12
2,20 kN/m <sup>2</sup>	W <sub>max</sub> (mm)	-	-	700	700	950	650	650	950	950	1100	1000	1500	1700
2,00 kN/m <sup>2</sup>		-	-	700	700	1000	700	700	1000	1000	1200	1050	1600	1800
1,60 kN/m <sup>2</sup>		-	-	800	800	1100	800	800	1100	1100	1200	1200	1600	1800
1,40 kN/m <sup>2</sup>		600	600	900	900	1300	850	850	1200	1200	1400	1250	1600	1800
1,04 kN/m <sup>2</sup>		700	700	1050	1050	1300	1000	1000	1300	1300	1400	1500	1700	1800
1,00 kN/m <sup>2</sup>		700	700	1050	1050	1300	1000	1000	1300	1300	1400	1500	1700	1800
0,70 kN/m <sup>2</sup>		900	900	1050	1050	1400	1100	1100	1400	1400	1500	1550	1700	1800

## MOD 2400

V4A 316



Flach  
oder Rohr  
Ø 48,3 mm

Wind- druck	Glasart T (mm)	VSG / ESG*				Mono / ESG-H*	
		12,76	13,52	16,76	17,52	12	15
2,20 kN/m <sup>2</sup>	W <sub>max</sub> (mm)	500	500	1000	1000	1400	1600
1,60 kN/m <sup>2</sup>		800	800	1200	1200	1500	1600
1,40 kN/m <sup>2</sup>		800	800	1400	1400	1600	1600
1,04 kN/m <sup>2</sup>		1200	1200	1600	1600	1600	1600
1,00 kN/m <sup>2</sup>		1200	1200	1600	1600	1600	1600
0,64 kN/m <sup>2</sup>		1500	1500	1600	1600	1600	1600



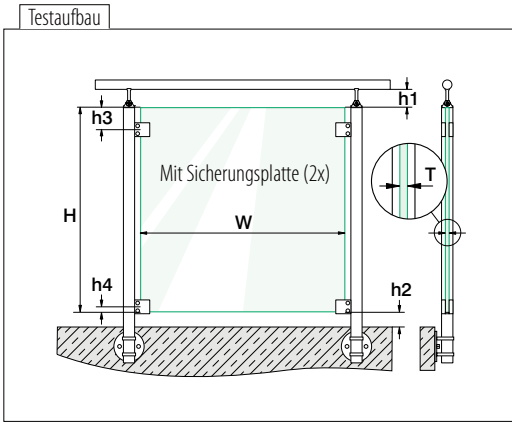

Abmessungen (mm)		min.	max.
W	Glasbreite	500	Siehe entspr. Modell
T	Glasstärke	Siehe entspr. Modell	Siehe entspr. Modell
H	Glashöhe	800	1000
h1	Abstand Handlauf - Glas	10	50 ohne Kantenschutz / 120 mit Kantenschutz
h2	Abstand Boden - Glas	10	50 ohne Kantenschutz / 120 mit Kantenschutz
h3	Glaskante oben - Achse obere Glasklemme	100 : MOD 2600, 2400 120 : MOD 4200	150
h4	Glaskante unten - Achse untere Glasklemme	29 : MOD 2400 22 : MOD 2600 16,5 : MOD 4200	29 : MOD 2400 22 : MOD 2600 16,5 : MOD 4200

# INDOOR



Glasklemmen ohne Sicherungstift, mit Sicherungsplatte.

## MOD 4200

V2A 304 Zinkdruckguss



Flach  
oder Rohr  
Ø 42,4 mm  
Ø 48,3 mm

Glasart	VSG / SPG*		VSG / TVG*		VSG / ESG*				Mono / ESG-H*				
	T (mm)	12,76	10,76	11,52	12,76	8,76	9,52	10,76	11,52	12,76	8	10	12
W <sub>max</sub> (mm)	1600	1600	1600	1600	1800	1800	1800	1800	1800	1800 <sup>1</sup> 2000 <sup>2</sup>	1800	1800	1800

<sup>1</sup> Zinkdruckguss <sup>2</sup> Edelstahl 304

## MOD 2600

V2A 304



Flach  
oder Rohr  
Ø 42,4 mm  
Ø 48,3 mm

Glasart	VSG / ESG*				Mono / ESG-H*			
	T (mm)	8,76	10,76	11,52	12,76	8	10	12
W <sub>max</sub> (mm)	1400	1400	1400	1400	1400	1400	1400	1400

## MOD 2400

V2A 304 Zinkdruckguss



Flach  
oder Rohr  
Ø 48,3 mm

Glasart	VSG / TVG*				VSG / ESG*				Mono / ESG-H*		
	T (mm)	12,76	13,52	16,76	17,52	12,76	13,52	16,76	17,52	12	15
W <sub>max</sub> (mm)	1500	1500	1500	1500	1600	1600	1600	1600	1600	1600	1600

GLASKLEMMEN

GLASBEFESTIGUNGEN

\* VSG: Verbundsicherheitsglas  
Mono: Monolithisches Glas

SPG: Spiegelglas  
TVG: Teilvorgespanntes Glas

ESG: Einscheibensicherheitsglas  
ESG-H: Einscheibensicherheitsglas - Heißlagerungstest



# OUTDOOR



Mögliche Glasbreite für die Anwendung im Außenbereich abhängig von Windlast, Glastyp und Glasstärke - ohne Sicherungsstift, mit Sicherungsplatte.

## MOD 4200

V4A 316



Flach  
oder Rohr  
Ø 42,4 mm  
Ø 48,3 mm

Wind- druck	Glasart T (mm)	VSG / TVG*					VSG / ESG*					Mono / ESG-H*		
		8,76	9,52	10,76	11,52	12,76	8,76	9,52	10,76	11,52	12,76	8	10	12
2,20 kN/m <sup>2</sup>	W <sub>max</sub> (mm)	-	-	700	700	1000	650	650	950	950	1100	1000	1500	1700
2,00 kN/m <sup>2</sup>		-	-	750	750	1050	700	700	1000	1000	1300	1050	1600	1800
1,60 kN/m <sup>2</sup>		-	-	850	850	1200	800	800	1100	1100	1300	1200	1600	1800
1,40 kN/m <sup>2</sup>		600	600	950	950	1300	850	850	1200	1200	1500	1250	1600	1800
1,04 kN/m <sup>2</sup>		700	700	1100	1100	1300	1000	1000	1400	1400	1500	1500	1700	1800
1,00 kN/m <sup>2</sup>		700	700	1100	1100	1300	1000	1000	1400	1400	1500	1500	1700	1800
0,70 kN/m <sup>2</sup>	900	900	1100	1100	1400	1050	1050	1500	1500	1600	1550	1700	1800	

## MOD 2600

V4A 316



Flach  
oder Rohr  
Ø 42,4 mm  
Ø 48,3 mm

Wind- druck	Glasart T (mm)	VSG / ESG*				Mono / ESG-H*		
		8,76	10,76	11,52	12,76	8	10	12
2,20 kN/m <sup>2</sup>	W <sub>max</sub> (mm)	500	800	800	800	800	1000	1400
1,60 kN/m <sup>2</sup>		800	800	800	1000	1000	1400	1400
1,40 kN/m <sup>2</sup>		800	1000	1000	1200	1200	1400	1400
1,04 kN/m <sup>2</sup>		800	1000	1000	1400	1400	1400	1400
1,00 kN/m <sup>2</sup>		800	1200	1200	1400	1400	1400	1400
0,64 kN/m <sup>2</sup>		1200	1400	1400	1400	1400	1400	1400

## MOD 2400

V4A 316



Flach  
oder Rohr  
Ø 48,3 mm

Wind- druck	Glasart T (mm)	VSG / TVG*				VSG / ESG*				Mono / ESG-H*	
		12,76	13,52	16,76	17,52	12,76	13,52	16,76	17,52	12	15
2,20 kN/m <sup>2</sup>	W <sub>max</sub> (mm)	500	500	500	500	500	500	1000	1000	1400	1600
1,60 kN/m <sup>2</sup>		500	500	800	800	800	800	1200	1200	1500	1600
1,40 kN/m <sup>2</sup>		500	500	1000	1000	800	800	1400	1400	1600	1600
1,04 kN/m <sup>2</sup>		800	800	1200	1200	1200	1200	1500	1500	1600	1600
1,00 kN/m <sup>2</sup>		800	800	1200	1200	1200	1200	1500	1500	1600	1600
0,64 kN/m <sup>2</sup>		1500	1500	1500	1500	1500	1500	1600	1600	1600	1600

# GLASBEFESTIGUNGEN – GLASSTÄRKEN

		Monolithisches Glas						Laminiertes Glas														
			Glasstärke (mm)						Glasstärke (mm)													
			6	8	10	12	15	19	6,76	8,38	8,76	9,52	10,76	11,52	12,76	13,52	16,76	17,52	20,76	21,52	25,52	
Glasklemmen	MOD 2700	433	■	■	■				■		■		■									
	MOD 2500	434	■	■	■	■			■		■	■	■	■	■							
	MOD 2800	435	■	■	■	■					■	■	■	■	■							
	MOD 4200	436 - 437	■	■	■	■			■	■	■	■	■	■	■							
	MOD 2100	438	■	■	■				■		■	■										
	MOD 2600	439		■	■	■					■		■	■	■							
	MOD 2400	440					■	■					■	■	■	■	■	■				
	MOD 2300	441					■	■	■				■	■	■	■	■	■	■	■	■	
	MOD 4400/4600	442		■	■							■		■								
	MOD 5100/5200	443		■	■							■		■								
	MOD 2900	444		■	■	■						■		■								
Glashalter	MOD 5500	446		■	■	■					■		■	■	■	■						
	MOD 5501	447		■	■	■					■		■	■	■	■						
Glasverbinder	MOD 2870/2880/2890	448	■	■	■	■					■	■	■	■	■		■	■	■	■		
	MOD 4270/4280/4290	449	■	■	■	■			■	■	■	■	■	■	■		■	■	■	■		
	MOD 0742	450						■	■						■	■	■	■	■	■		
Scharniere und Türriegel	MOD 0283/0281	451	■	■	■	■			■	■	■	■	■	■	■							
	MOD 0284/0282	450	■	■	■	■			■	■	■	■	■	■	■							
Glasadapter	MOD 0754	453		■	■	■	■			■	■	■	■	■	■	■	■	■				
	MOD 0746	454	■	■	■	■	■		■	■	■	■	■	■	■	■	■	■				
	MOD 0740	454	■	■	■	■	■		■	■	■	■	■	■	■	■	■	■				
	MOD 0755	454	■	■	■	■			■	■	■	■	■	■	■							
	MOD 0747/1747	455		■	■	■	■		■	■	■	■	■	■	■	■	■	■	■	■	■	■

Das Q-railing Sortiment bietet Halter für Glasfüllungen in verschiedenen Ausführungen an. Prüfen Sie die Optionen und die entsprechenden Artikelcodes für Produkte aus Zinkdruckguss, Edelstahl und Aluminium auf Seite 7.

## Glasklemmen - MOD 2700

Für flaches Rohr

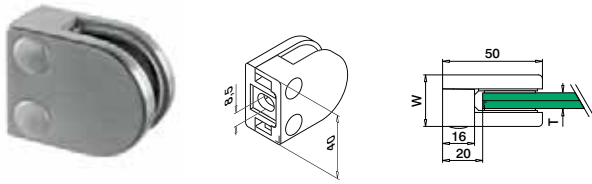

Für rundes Rohr

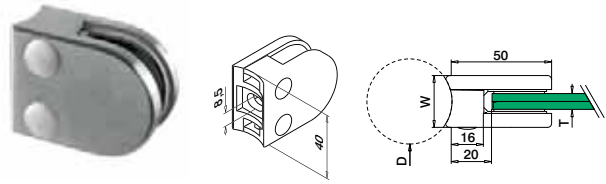

### MOD 2700

V2A	304	Gebürstet				
INDOOR		W	T			
132700-000-12	26	Siehe MOD 5027	QS-26		476	4

V4A	316	Gebürstet				
OUTDOOR		W	T			
142700-000-12	26	Siehe MOD 5027	QS-27		476	4

Zinkdruckguss						
INDOOR		W	T			
102700-000-...	28	Siehe MOD 5027	QS-28		476	4



### MOD 2700

V2A	304	Gebürstet				
INDOOR		D	W	T		
132700-033-12	33,7	26	Siehe MOD 5027	QS-47		476 4
132700-042-12	42,4	26	Siehe MOD 5027	QS-47		476 4

V4A	316	Gebürstet				
OUTDOOR		D	W	T		
142700-033-12	33,7	26	Siehe MOD 5027	QS-45		476 4
142700-042-12	42,4	26	Siehe MOD 5027	QS-45		476 4

Zinkdruckguss						
INDOOR		D	W	T		
102700-033-...	33,7	28	Siehe MOD 5027	QS-46		476 4
102700-042-...	42,4	28	Siehe MOD 5027	QS-46		476 4



## Gummieinlagen für MOD 2700



2 Stück pro Glasklemme

### MOD 5027

Zubehör		
Für monolithisches Glas	T	
205027-06	6	8
205027-08	8	8
205027-10	10	8

Für laminiertes Glas		
	T	
205027-07	6,76	8
205027-09	8,76	8
205027-11	10,76	8

Nur solange der Vorrat reicht.

Bitte bestellen Sie Befestigungsmaterial separat.

### Q-INFO



Artikel mit .00-Ausführung können pulverbeschichtet werden.

### Q-INFO Zinkdruckguss MOD 2700 Oberflächen

	00	17	19
	Roh	Glanzverchromt	Edelstahleffekt
	102700-000-00	102700-000-17	102700-000-19
			102700-0xx-19

### Q-INFO MOD 1062

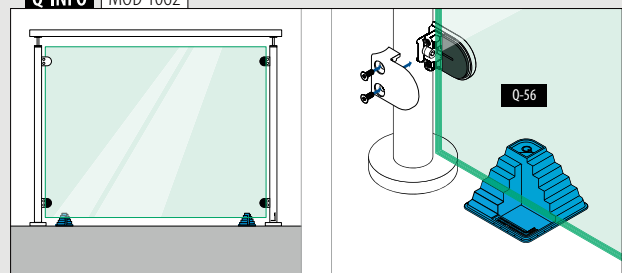

Glasklemmen - MOD 2500

Für flaches Rohr

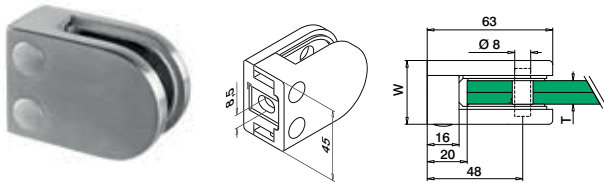

MOD 2500

V2A	304	Gebürstet				
INDOOR		W	T			
132500-000-12	30	Siehe MOD 5025	QS-26		476	4
V4A	316	Gebürstet				
OUTDOOR						
142500-000-12	30	Siehe MOD 5025	QS-27		476	4
V4A	316	Hochglanzpoliert				
OUTDOOR						
142500-000-10	30	Siehe MOD 5025	QS-27		476	4
V4A	316	Black Line				
OUTDOOR						
<b>NEW</b> 142500-000-82	30	Siehe MOD 5025	QS-27		476	4
Zinkdruckguss						
INDOOR						
<b>SELL OUT</b> 102500-000-...	32	Siehe MOD 5025	QS-28		476	4



AbZ nicht für 6 und 6,76 mm Glas.

Für rundes Rohr

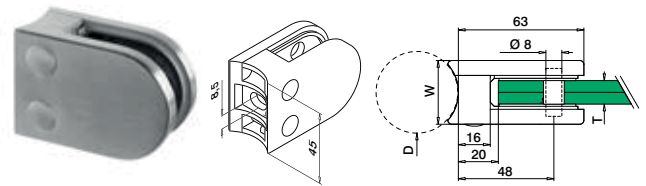

MOD 2500

V2A	304	Gebürstet				
INDOOR		D	W	T		
132500-042-12	42,4	30	Siehe MOD 5025	QS-47		476 4
132500-048-12	48,3	30	Siehe MOD 5025	QS-47		476 4
V4A	316	Gebürstet				
OUTDOOR						
142500-042-12	42,4	30	Siehe MOD 5025	QS-45		476 4
142500-048-12	48,3	30	Siehe MOD 5025	QS-45		476 4
V4A	316	Hochglanzpoliert				
OUTDOOR						
142500-042-10	42,4	30	Siehe MOD 5025	QS-45		476 4
142500-048-10	48,3	30	Siehe MOD 5025	QS-45		476 4
Zinkdruckguss						
INDOOR						
<b>SELL OUT</b> 102500-042-...	42,4	32	Siehe MOD 5025	QS-46		476 4
<b>SELL OUT</b> 102500-048-...	48,3	32	Siehe MOD 5025	QS-46		476 4



Gummieinlagen für MOD 2500



2 Stück pro Glasklemme

MOD 5025

Zubehör		
Für monolithisches Glas	T	
205025-06	6	8
205025-08	8	8
205025-10	10	8
205025-12	12	8
Für laminiertes Glas		
205025-07	6,76	8
205025-09	8,76	8
205025-44	9,52	8
205025-11	10,76	8
205025-54	11,52	8
205025-13	12,76	8

Sicherungsstifte

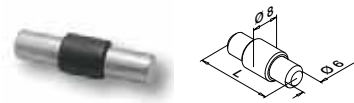

Optional verwendbar für MOD 2500

MOD 5015

Zubehör		
	L	
205015-25	25	4

**SELL OUT** Nur solange der Vorrat reicht.

Q-INFO 316 MOD 2500 Oberflächen

10	12	82 RAL 9005
Hochglanzpoliert	Gebürstet	Pulverbeschichtet
		Schwarz, matt, strukturiert

Q-INFO Zinkdruckguss MOD 2500 Oberflächen

00	17	19	32 RAL 9016	82 RAL 9005	89 RAL 9005
Roh	Glanzverchromt	Edstahleffekt	Indoor Weiß, satiniert, glatt	Schwarz, matt, strukturiert	Schwarz, matt, glatt
	102500-000-00	102500-000-17	102500-000-19	102500-000-32	102500-000-82
	102500-04x-00	102500-04x-19			

Q-INFO MOD 5015 / 2500

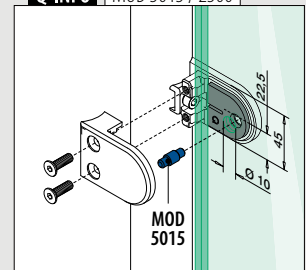



Glasklemmen - MOD 2800

Für flaches Rohr

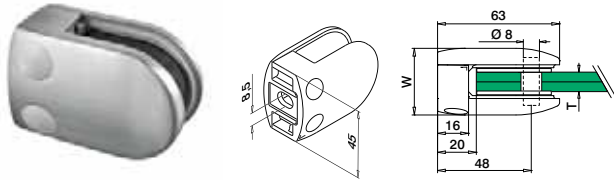

Für rundes Rohr

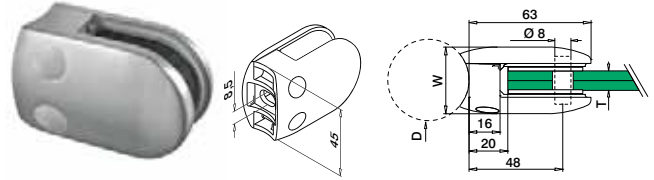

MOD 2800

V2A	304	Gebürstet				
INDOOR		W	T			
132800-000-12	34	Siehe MOD 5028	QS-26		476	4
V2A	304	Hochglanzpoliert				
INDOOR						
132800-000-10	34	Siehe MOD 5028	QS-26		476	4
V4A	316	Gebürstet				
OUTDOOR						
142800-000-12	34	Siehe MOD 5028	QS-27		476	4
V4A	316	Hochglanzpoliert				
OUTDOOR						
142800-000-10	34	Siehe MOD 5028	QS-27		476	4
V4A	316	Black Line				
OUTDOOR						
142800-000-82	34	Siehe MOD 5028	QS-27		476	4
Zinkdruckguss						
INDOOR						
102800-000-...	36	Siehe MOD 5028	QS-28		476	4



Internationaler Geschmacksmusterschutz

MOD 2800

V2A	304	Gebürstet				
INDOOR		D	W	T		
132800-042-12	42,4	34	Siehe MOD 5028	QS-47		476
132800-048-12	48,3	34	Siehe MOD 5028	QS-47		476
V2A	304	Hochglanzpoliert				
INDOOR						
132800-042-10	42,4	34	Siehe MOD 5028	QS-47		476
132800-048-10	48,3	34	Siehe MOD 5028	QS-47		476
V4A	316	Gebürstet				
OUTDOOR						
142800-042-12	42,4	34	Siehe MOD 5028	QS-45		476
142800-048-12	48,3	34	Siehe MOD 5028	QS-45		476
V4A	316	Hochglanzpoliert				
OUTDOOR						
142800-042-10	42,4	34	Siehe MOD 5028	QS-45		476
142800-048-10	42,4	34	Siehe MOD 5028	QS-45		476
Zinkdruckguss						
INDOOR						
102800-042-...	42,4	36	Siehe MOD 5028	QS-46		476
102800-048-...	48,3	36	Siehe MOD 5028	QS-46		476



Internationaler Geschmacksmusterschutz

Gummieinlagen für MOD 2800



2 Stück pro Glasklemme

MOD 5028

Zubehör		
Für monolithisches Glas	T	
205028-06	6	8
205028-08	8	8
205028-10	10	8
205028-12	12	8
Für laminiertes Glas		
205028-09	8,76	8
205028-44	9,52	8
205028-11	10,76	8
205028-54	11,52	8
205028-13	12,76	8

Zubehör

Sicherungsstifte

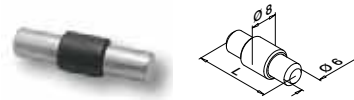

Optional verwendbar für MOD 2800

MOD 5015

Zubehör		
	L	
205015-22	22	4

Q-INFO 304 316 MOD 2800 Oberflächen



Q-INFO Zinkdruckguss MOD 2800 Oberflächen

00	17	19	82 RAL 9005	89 RAL 9005
Roh	Glanzverchromt	Edelstahleffekt	Pulverbeschichtet	Pulverbeschichtet INDOOR
	102800-000-00	102800-000-17	102800-000-19	102800-000-82
	102800-04x-00	102800-04x-19	102800-04x-82	102800-04x-89

Q-INFO MOD 5015 / 2800

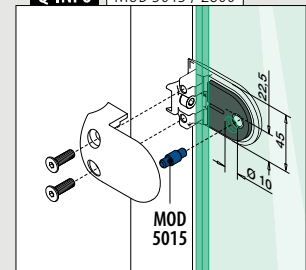

Glasklemmen - MOD 4200

Für flaches Rohr

Inklusive Sicherungsplatte

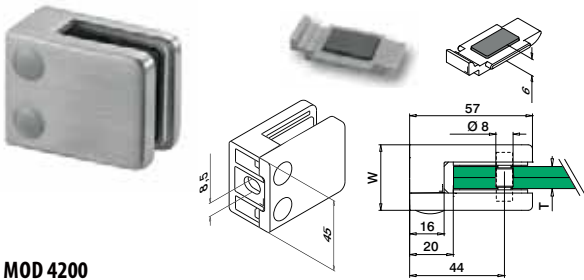

Für rundes Rohr

Inklusive Sicherungsplatte

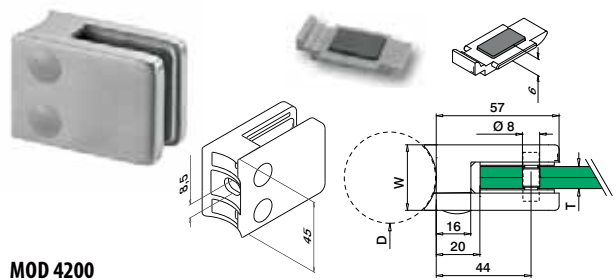

MOD 4200

V2A	304	Gebürstet			
	<b>INDOOR</b>	<b>W</b>	<b>T</b>		
	134200-000-12	28	Siehe MOD 5042	QS-26	476 4
V4A	316	Gebürstet			
	<b>OUTDOOR</b>				
	144200-000-12	28	Siehe MOD 5042	QS-27	476 4
V4A	316	Hochglanzpoliert			
	<b>OUTDOOR</b>				
	144200-000-10	28	Siehe MOD 5042	QS-27	476 4
V4A	316	Black Line			
	<b>OUTDOOR</b>				
<b>NEW</b>	144200-000-82	28	Siehe MOD 5042	QS-27	476 4
	<b>Zinkdruckguss</b>				
	<b>INDOOR</b>				
<b>SELL OUT</b>	104200-000-...	30	Siehe MOD 5042	QS-28	476 4



Internationaler Geschmacksmusterschutz

MOD 4200

V2A	304	Gebürstet			
	<b>INDOOR</b>	<b>D</b>	<b>W</b>	<b>T</b>	
	134200-042-12	42,4	28	Siehe MOD 5042	QS-47 476 4
	134200-048-12	48,3	28	Siehe MOD 5042	QS-47 476 4
V2A	304	Black Line			
	<b>INDOOR</b>				
<b>NEW</b>	134200-042-82	42,4	28	Siehe MOD 5042	QS-47 476 4
V4A	316	Gebürstet			
	<b>OUTDOOR</b>				
	144200-042-12	42,4	28	Siehe MOD 5042	QS-45 476 4
	144200-048-12	48,3	28	Siehe MOD 5042	QS-45 476 4
V4A	316	Hochglanzpoliert			
	<b>OUTDOOR</b>				
	144200-042-10	42,4	28	Siehe MOD 5042	QS-45 476 4
	144200-048-10	48,3	28	Siehe MOD 5042	QS-45 476 4
	<b>Zinkdruckguss</b>				
	<b>INDOOR</b>				
<b>SELL OUT</b>	104200-042-...	42,4	30	Siehe MOD 5042	QS-46 476 4
<b>SELL OUT</b>	104200-048-...	48,3	30	Siehe MOD 5042	QS-46 476 4



Internationaler Geschmacksmusterschutz

Q-INFO 304 316 MOD 4200 Oberflächen

10

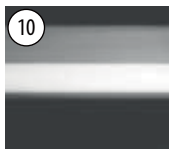

Hochglanzpoliert

12

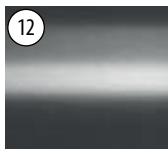

Gebürstet

82 RAL 9005



Schwarz, matt, strukturiert

Q-INFO

00



Artikel mit .00-Ausführung können pulverbeschichtet werden.



Q-INFO



420

MOD 4200 ist auch als Blechadapter erhältlich

Q-INFO Zinkdruckguss MOD 4200 Oberflächen

00



Roh

17



Glanzverchromt

19

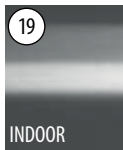

Edelstahleffekt

32 RAL 9016



Weiß, satiniert, glatt

33 RAL 7016



Anthrazitgrau, matt, strukturiert

36 RAL 9006



Weißaluminium, satiniert, glatt

82 RAL 9005



Schwarz, matt, strukturiert

89 RAL 9005



Schwarz, matt, glatt



104200-000-00

104200-000-17

104200-000-19

104200-000-32

104200-000-33

104200-000-36

104200-000-82

104200-000-89



104200-04x-00

104200-04x-19

104200-042-82

104200-042-89

Glasklemmen - MOD 4200

Für flaches Rohr

Inklusive Sicherungsplatte

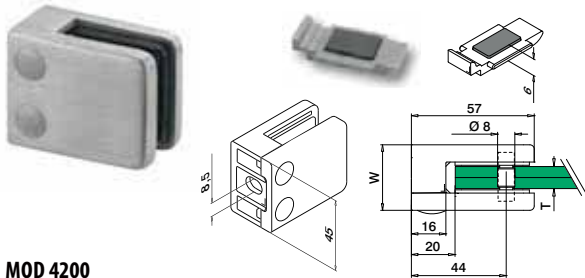

MOD 4200

Aluminium

INDOOR	W	T		
164200-000-...	30	Siehe MOD 5042	QS-26	476 4



Für rundes Rohr

Inklusive Sicherungsplatte

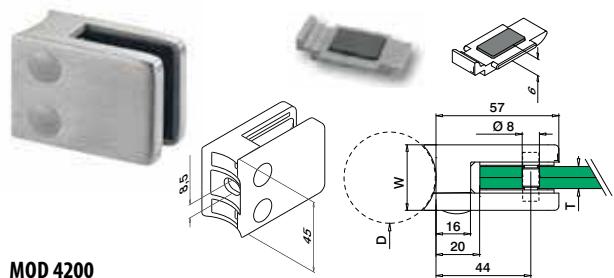

MOD 4200

Aluminium

INDOOR	D	W	T		
164200-042-...	42,4	30	Siehe MOD 5042	QS-47	476 4
164200-048-...	48,3	30	Siehe MOD 5042	QS-47	476 4



Gummieinlagen für MOD 4200



2 Stück pro Glasklemme

MOD 5042

Zubehör

Für monolithisches Glas	T	
205042-06	6	8
205042-08	8	8
205042-10	10	8
205042-12	12	8

Für laminiertes Glas

205042-07	6,76	8
205042-41	8,38	8
205042-09	8,76	8
205042-44	9,52	8
205042-11	10,76	8
205042-54	11,52	8
205042-13	12,76	8

Sicherungsstifte

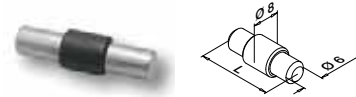

Optional verwendbar für MOD 4200

MOD 5015

Zubehör

	L	
205015-22	22	4

Q-INFO



Verwenden Sie die Sicherungsplatte anstelle des Sicherungsstiftes. Das spart Ihnen Zeit und Kosten, weil Löcher im Glas nicht notwendig sind.

Q-INFO Aluminium MOD 4200 Oberflächen

00	32 RAL 9016	33 RAL 7016	36 RAL 9006	82 RAL 9005	89 RAL 9005
Roh	Pulverbeschichtet INDOOR Weiß, satiniert, glatt	Anthrazitgrau, matt, glatt	Weißaluminium, satiniert, glatt	Pulverbeschichtet Schwarz, matt, strukturiert	Pulverbeschichtet INDOOR Schwarz, matt, glatt
□ 164200-000-00	164200-000-32	164200-000-33	164200-000-36	164200-000-82	164200-000-89
○ 164200-04x-00				164200-04x-82	

Q-INFO MOD 5015 / 4200

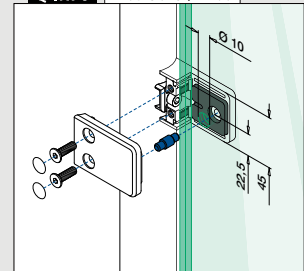

## Glasklemmen - MOD 2100

Für flaches Rohr

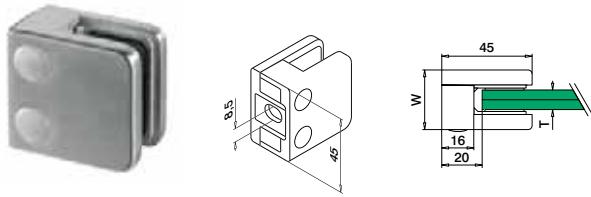

### MOD 2100

V2A	304	Gebürstet			
INDOOR			W	T	
132100-000-12	27	Siehe MOD 5021	QS-26	476	4
V2A	304	Black Line			
INDOOR					
NEW 132100-000-82	27	Siehe MOD 5021	QS-26	476	4
V4A	316	Gebürstet			
OUTDOOR					
142100-000-12	27	Siehe MOD 5021	QS-27	476	4



MOD 2100 getestet für INDOOR, 8 mm

### MOD 2100

#### Zinkdruckguss

INDOOR			W	T	
SELL OUT 102100-000-...	29	Siehe MOD 5021	QS-28	476	4



Für rundes Rohr

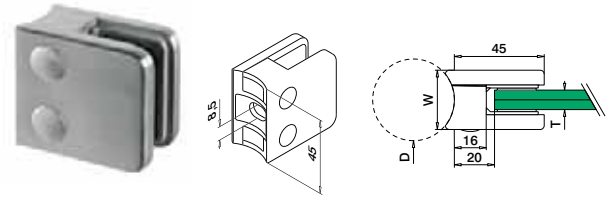

### MOD 2100

V2A	304	Gebürstet			
INDOOR			D	W	T
132100-042-12	42,4	27	Siehe MOD 5021	QS-47	476
V4A	316	Gebürstet			
OUTDOOR					
142100-042-12	42,4	27	Siehe MOD 5021	QS-45	476



MOD 2100 getestet für INDOOR, 8 mm

### MOD 2100

#### Zinkdruckguss

INDOOR			D	W	T
SELL OUT 102100-042-...	42,4	29	Siehe MOD 5021	QS-46	476



## Gummieinlagen für MOD 2100



2 Stück pro Glasklemme

### MOD 5021

#### Zubehör

Für monolithisches Glas			T	
205021-06	6			8
205021-08	8			8
205021-10	10			8
Für laminiertes Glas				
205021-07	6,76			8
205021-09	8,76			8
205021-44	9,52			8

### Q-INFO 304 316 Oberflächen

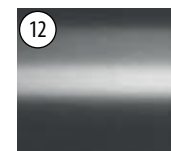

12 Gebürstet



82 RAL 9005  
Pulverbeschichtet

### Q-INFO Zinkdruckguss MOD 2100 Oberflächen



00 Roh



17 Glanzverchromt

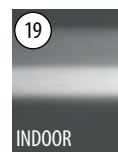

19 Edelfstahleffekt



32 RAL 9016  
Pulverbeschichtet  
INDOOR  
Weiß, satiniert, glatt



82 RAL 9005  
Pulverbeschichtet  
Schwarz, matt, strukturiert



89 RAL 9005  
Pulverbeschichtet  
INDOOR  
Schwarz, matt, glatt

102100-000-00	102100-000-17	102100-000-19	102100-000-32	102100-000-82	102100-000-89
---------------	---------------	---------------	---------------	---------------	---------------

102100-042-00		102100-042-19			
---------------	--	---------------	--	--	--

### Q-INFO

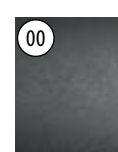

00 Artikel mit .00-Ausführung können pulverbeschichtet werden.



Glasklemmen - MOD 2600

Für flaches Rohr

Inklusive Sicherungsplatte

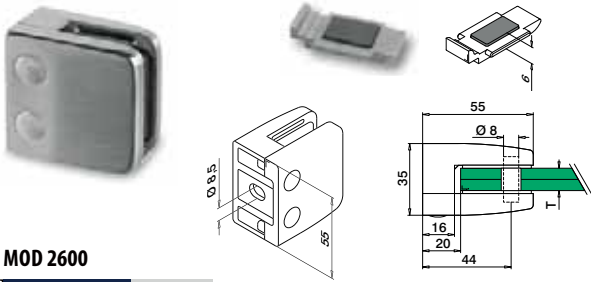

MOD 2600

V2A 304 Gebürstet

SELL OUT	INDOOR	T		
132600-000-12	Siehe MOD 5026	QS-26	476	4

V4A 316 Gebürstet

SELL OUT	OUTDOOR			
142600-000-12	Siehe MOD 5026	QS-27	476	4



Für rundes Rohr

Inklusive Sicherungsplatte

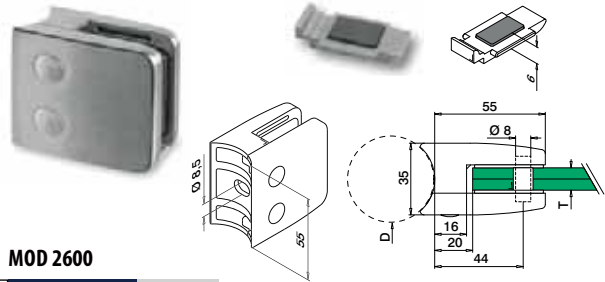

MOD 2600

V2A 304 Gebürstet

SELL OUT	INDOOR	D	T		
132600-042-12*	42,4	Siehe MOD 5026	QS-47	476	4
132600-048-12	48,3	Siehe MOD 5026	QS-47	476	4

V4A 316 Gebürstet

SELL OUT	OUTDOOR				
142600-042-12*	42,4	Siehe MOD 5026	QS-45	476	4
142600-048-12	48,3	Siehe MOD 5026	QS-45	476	4
142600-060-12	60,3	Siehe MOD 5026	QS-45	476	4



Gummieinlagen für MOD 2600



2 Stück pro Glasklemme

MOD 5026

Zubehör

SELL OUT	Für monolithisches Glas	T	
205026-08	8	8	
205026-10	10	8	
205026-12	12	8	

Für laminiertes Glas

SELL OUT			
205026-09	8,76	8	
205026-11	10,76	8	
205026-54	11,52	8	
205026-13	12,76	8	

SELL OUT Nur solange der Vorrat reicht.

Bitte bestellen Sie Befestigungsmaterial separat.

Zubehör

Sicherungsstifte

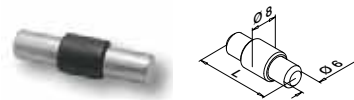

Optional verwendbar für MOD 2600

MOD 5015

Zubehör

SELL OUT		L	
205015-25	25	4	

Q-INFO MOD 5015 / 2600

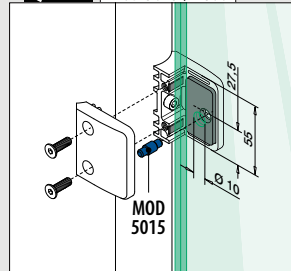

Q-INFO



Q-INFO MOD 2600

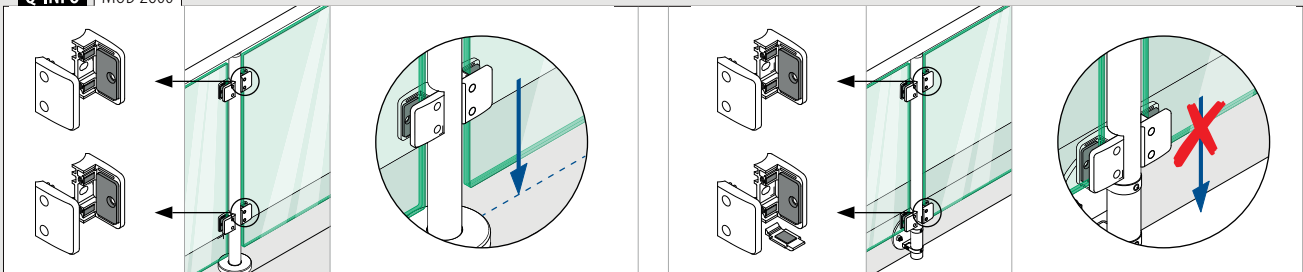



## Glasklemmen - MOD 2400

Für flaches Rohr

Inklusive Sicherungsplatte

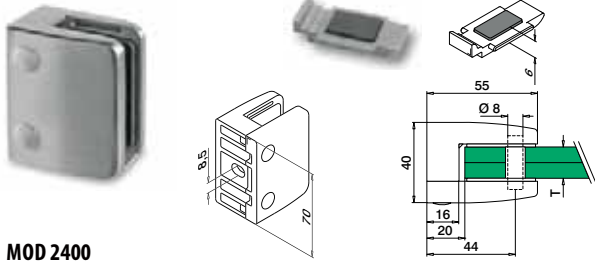

### MOD 2400

V2A	304	Gebürstet		
<b>INDOOR</b>				
SELL OUT	132400-000-12	Siehe T in MOD 5024	QS-26	476 4
V2A	304	Hochglanzpoliert		
<b>INDOOR</b>				
SELL OUT	132400-000-10	Siehe T in MOD 5024	QS-26	476 4
V4A	316	Gebürstet		
<b>OUTDOOR</b>				
SELL OUT	142400-000-12	Siehe T in MOD 5024	QS-27	476 4
V4A	316	Hochglanzpoliert		
<b>OUTDOOR</b>				
SELL OUT	142400-000-10	Siehe T in MOD 5024	QS-27	476 4
<b>Zinkdruckguss</b>				
<b>INDOOR</b>				
SELL OUT	102400-000-...	Siehe T in MOD 5024	QS-28	476 4



Füllungen

## Gummieinlagen für MOD 2400



2 Stück pro Glasklemme

### MOD 5024

#### Zubehör

Für monolithisches Glas		
SELL OUT		
205024-12	12	8
205024-15	15	8
Für laminiertes Glas		
205024-44	9,52	8
205024-54	11,52	8
205024-13	12,76	8
205024-64	13,52	8
205024-17	16,76	8
205024-18	17,52	8

#### Q-INFO Zinkdruckguss Oberflächen

	00	19
	Roh	Edelstahleffekt
□	102400-000-00	102400-000-19
○	102400-048-00	

Für rundes Rohr

Inklusive Sicherungsplatte

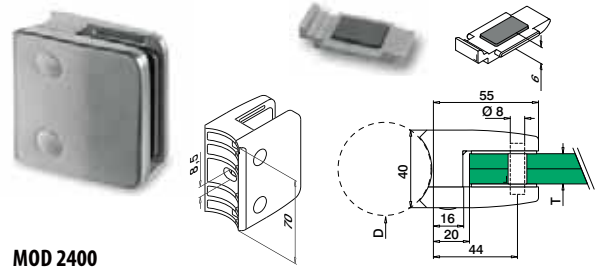

### MOD 2400

V2A	304	Gebürstet		
<b>INDOOR</b>				
SELL OUT	132400-048-12	48,3	Siehe T in MOD 5024	QS-47 476 4
V4A	316	Gebürstet		
<b>OUTDOOR</b>				
SELL OUT	142400-048-12	48,3	Siehe T in MOD 5024	QS-45 476 4
<b>Zinkdruckguss</b>				
<b>INDOOR</b>				
SELL OUT	102400-048-...	48,3	Siehe T in MOD 5024	QS-46 476 4



Zubehör

## Sicherungsstifte

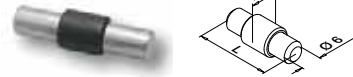

Optional verwendbar für MOD 2400

### MOD 5015

#### Zubehör

	L	
205015-24	30	4

SELL OUT Nur solange der Vorrat reicht.

#### Q-INFO MOD 5015 / 2400

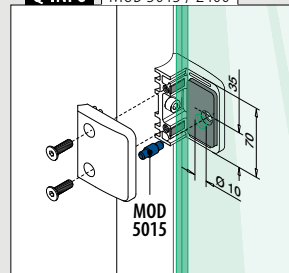

#### Q-INFO



#### Q-INFO 304 316



#### Q-INFO



Glasklemmen - MOD 2300

Für flaches Rohr + Wandmontage

Inklusive Sicherungsplatte

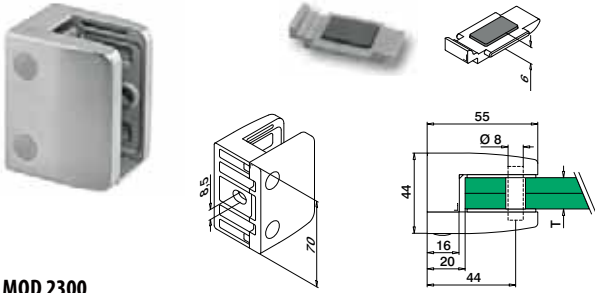

MOD 2300

V2A	304	Gebürstet			
<b>INDOOR</b>		<b>T</b>			
NEW	132300-000-12	Siehe T in MOD 5023	QS-26	476	4
V4A	316	Gebürstet			
<b>OUTDOOR</b>					
142300-000-12	Siehe T in MOD 5023	QS-27	476	4	



Für rundes Rohr

Inklusive Sicherungsplatte

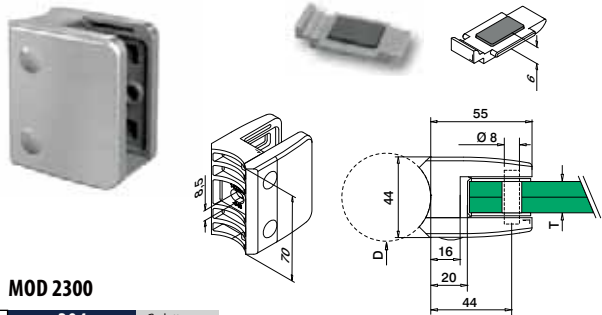

MOD 2300

V2A	304	Gebürstet			
<b>INDOOR</b>		<b>D</b>	<b>T</b>		
132300-048-12	48,3	Siehe T in MOD 5023	QS-47	476	4
V4A	316	Gebürstet			
<b>OUTDOOR</b>					
142300-048-12	48,3	Siehe T in MOD 5023	QS-45	476	4

NEW

Gummieinlagen für MOD 2300



2 Stück pro Glasklemme

MOD 5023

Zubehör

Für monolithisches Glas		<b>T</b>	
NEW	205023-12	12	8
NEW	205023-15	15	8
	205023-19	19	8

Für laminiertes Glas

NEW	205023-44	9,52	8
NEW	205023-54	11,52	8
NEW	205023-13	12,76	8
NEW	205023-64	13,52	8
NEW	205023-17	16,76	8
NEW	205023-18	17,52	8
	205023-21	20,76	8
	205023-22	21,52	8

Bitte bestellen Sie Befestigungsmaterial separat.

Q-INFO

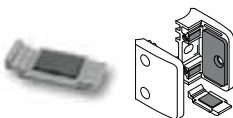

Verwenden Sie die Sicherungsplatte anstelle des Sicherungsstiftes. Das spart Ihnen Zeit und Kosten, weil Löcher im Glas nicht notwendig sind.

Q-INFO MOD 5015 / 2300

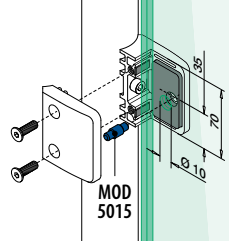

Sicherungsstifte

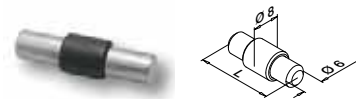

Optional verwendbar für MOD 2300

MOD 5015

Zubehör

	<b>L</b>	
205015-23	34	4

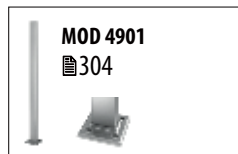

Q-INFO MOD 2300

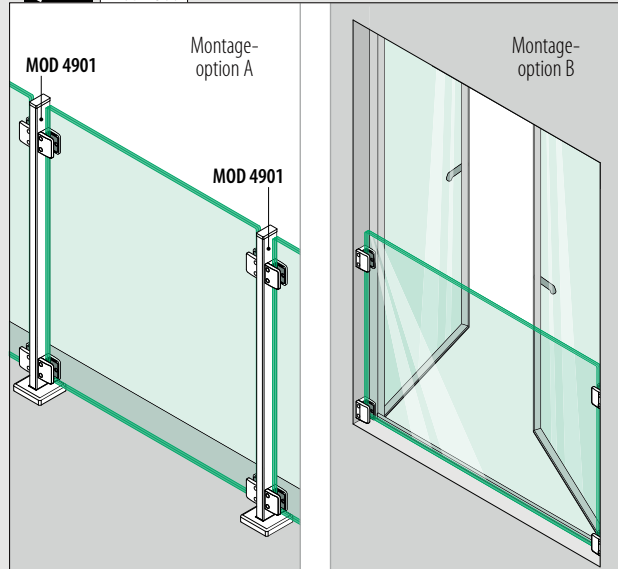

Glasklemmen - MOD 4400 / 4600

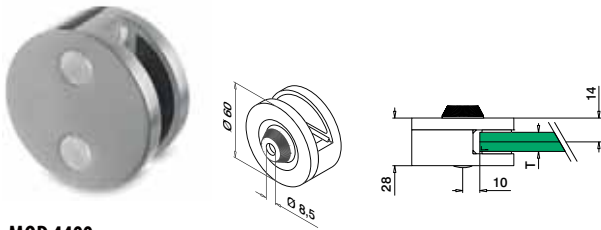

**MOD 4400**

<b>V2A</b>	<b>304</b>	Gebürstet		
<b>INDOOR</b>		<b>T</b>		
134400-12	Siehe T in MOD 5044		QS-47	4
<b>V4A</b>	<b>316</b>	Gebürstet		
<b>OUTDOOR</b>				
144400-12	Siehe T in MOD 5044		QS-45	4
<b>Zinkdruckguss</b>		Edelstahleffekt		
<b>OUTDOOR</b>				
<b>SELL OUT</b>	104400-20	Siehe T in MOD 5044		QS-46

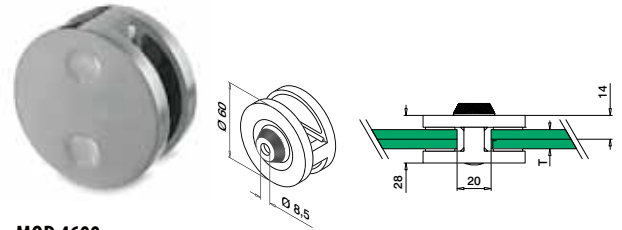

**MOD 4600**

<b>V2A</b>	<b>304</b>	Gebürstet		
<b>INDOOR</b>		<b>T</b>		
134600-12	Siehe T in MOD 5044		QS-47	4
<b>V4A</b>	<b>316</b>	Gebürstet		
<b>OUTDOOR</b>				
144600-12	Siehe T in MOD 5044		QS-45	4
<b>Zinkdruckguss</b>		Edelstahleffekt		
<b>OUTDOOR</b>				
<b>SELL OUT</b>	104600-20	Siehe T in MOD 5044		QS-46



Adapter für MOD 4400 / 4600

Für flaches Rohr



**MOD 0723**

<b>V2A</b>	<b>304</b>	Gebürstet		
<b>INDOOR</b>				
130723-000-12				4
<b>V4A</b>	<b>316</b>	Gebürstet		
<b>OUTDOOR</b>				
140723-000-12				4
<b>Zinkdruckguss</b>		Edelstahleffekt		
<b>OUTDOOR</b>				
<b>SELL OUT</b>	100723-000			4

Für rundes Rohr

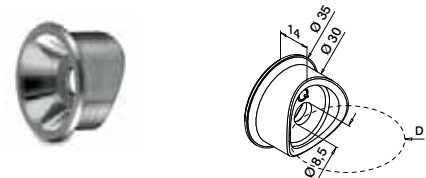

**MOD 0723**

<b>V2A</b>	<b>304</b>	Gebürstet		
<b>INDOOR</b>		<b>D</b>		
130723-042-12	42,4			4
<b>SELL OUT</b>	130723-048-12	48,3		4
<b>V4A</b>	<b>316</b>	Gebürstet		
<b>OUTDOOR</b>				
140723-042-12	42,4			4
140723-048-12	48,3			4
<b>Zinkdruckguss</b>		Edelstahleffekt		
<b>OUTDOOR</b>				
<b>SELL OUT</b>	100723-042	42,4		4

Gummieinlagen für MOD 4400 / 4600



2 Stück für MOD 4400,  
4 Stück für MOD 4600

**MOD 5044**

**Zubehör**

<b>Für monolithisches Glas</b>		<b>T</b>	
205044-08	8		8
205044-10	10		8
205044-12	12		8
<b>Für laminiertes Glas</b>			
205044-09	8,76		8
205044-11	10,76		8
205044-13	12,76		8

**SELL OUT** Nur solange der Vorrat reicht.

**Q-INFO**

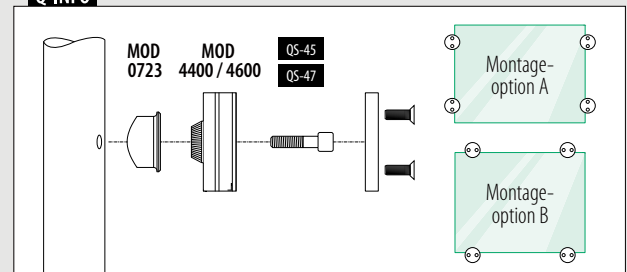

Glasklemmen - MOD 5100 / 5200

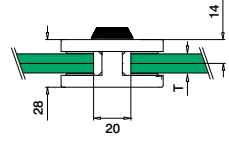
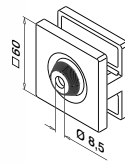
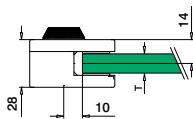
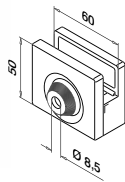

**MOD 5100**

V2A	<b>304</b>	Gebürstet			
	<b>INDOOR</b>	<b>T</b>			
	135100-12	Siehe T in MOD 5051	QS-47	476	4
V4A	<b>316</b>	Gebürstet			
	<b>OUTDOOR</b>				
	145100-12	Siehe T in MOD 5051	QS-45	476	4



**MOD 5200**

V2A	<b>304</b>	Gebürstet			
	<b>INDOOR</b>	<b>T</b>			
	135200-12	Siehe T in MOD 5051	QS-47	476	4
V4A	<b>316</b>	Gebürstet			
	<b>OUTDOOR</b>				
	145200-12	Siehe T in MOD 5051	QS-45	476	4



Adapter für MOD 5100 / 5200

Für flaches Rohr

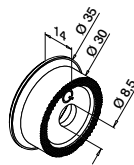

**MOD 0723**

V2A	<b>304</b>	Gebürstet			
	<b>INDOOR</b>				
	130723-000-12			4	
V4A	<b>316</b>	Gebürstet			
	<b>OUTDOOR</b>				
	140723-000-12			4	

Für rundes Rohr

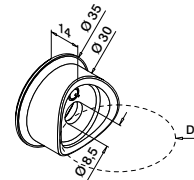

**MOD 0723**

V2A	<b>304</b>	Gebürstet			
	<b>INDOOR</b>	<b>D</b>			
	130723-042-12	42,4		4	
SELL OUT	130723-048-12	48,3		4	
V4A	<b>316</b>	Gebürstet			
	<b>OUTDOOR</b>				
	140723-042-12	42,4		4	
	140723-048-12	48,3		4	

Gummieinlagen für MOD 5100 / 5200



2 Stück für MOD 5100,  
4 Stück für MOD 5200

**MOD 5051**

Zubehör

Für monolithisches Glas	<b>T</b>	
205051-08	8	8
205051-10	10	8
Für laminiertes Glas		
205051-09	8,76	8
205051-11	10,76	8
205051-13	12,76	8

**Q-INFO**

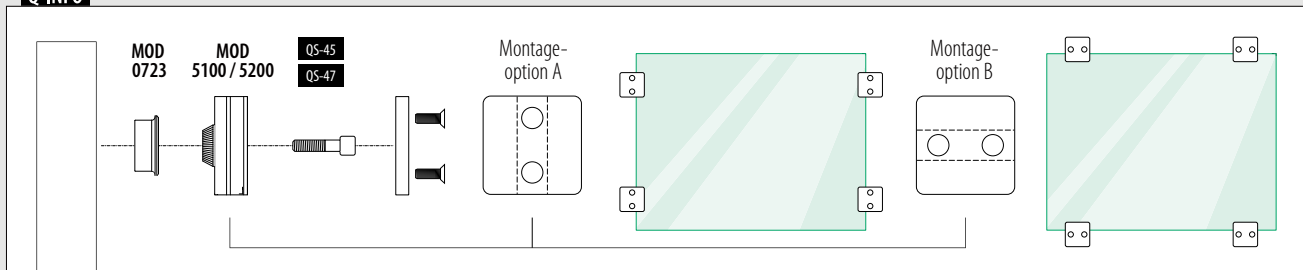

Glasklemmen - MOD 2900

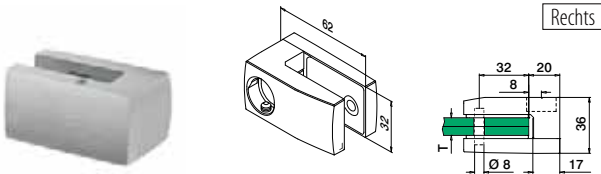

Rechts

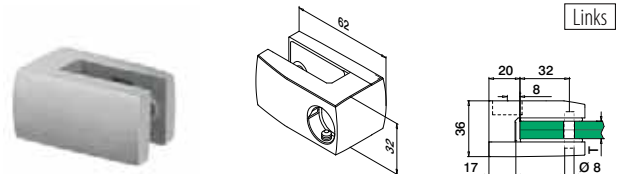

Links

MOD 2900

V4A	316	Gebürstet		
<b>OUTDOOR</b>		<b>T</b>		
SELL OUT	142900-01-12	Siehe T in MOD 5029		2



Internationaler Geschmacksmusterschutz

MOD 2900

V4A	316	Gebürstet		
<b>OUTDOOR</b>		<b>T</b>		
SELL OUT	142900-02-12	Siehe T in MOD 5029		2



Internationaler Geschmacksmusterschutz

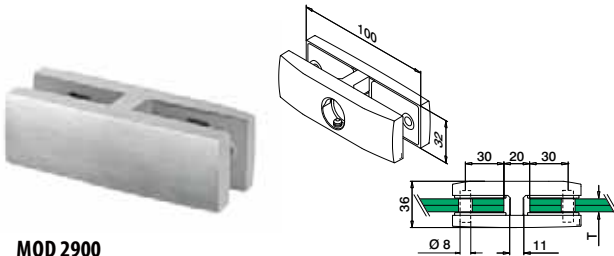

MOD 2900

V4A	316	Gebürstet		
<b>OUTDOOR</b>		<b>T</b>		
SELL OUT	142900-00-12	Siehe T in MOD 5029		2



Internationaler Geschmacksmusterschutz

Zubehör

Sicherungsstifte

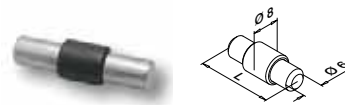

Optional verwendbar für MOD 2900

MOD 5015

<b>Zubehör</b>			
	<b>L</b>		
205015-22	22		4

Adapter für MOD 2900

Für flaches Rohr



MOD 0785

V4A	316	Gebürstet		
<b>OUTDOOR</b>				
140785-000-12	QS-16	474		4



Für rundes Rohr

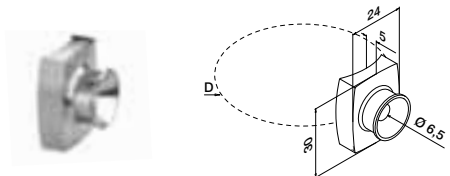

MOD 0785

V4A	316	Gebürstet		
<b>OUTDOOR</b>		<b>D</b>		
140785-042-12	42,4	QS-16	474	4
140785-048-12	48,3	QS-16	474	4



Q-INFO MOD 0785

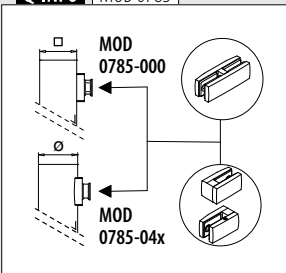

Bitte bestellen Sie Befestigungsmaterial separat.

Nur solange der Vorrat reicht.

Q-INFO MOD 2900

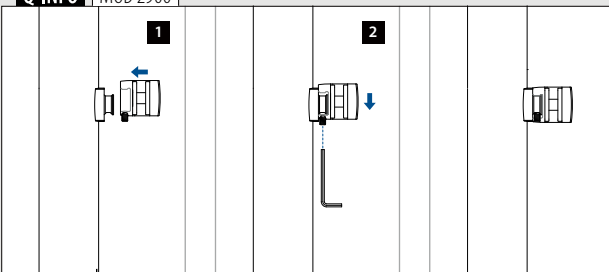

Gummieinlagen für MOD 2900



2 Stück pro Glasklemme,  
4 Stück für MOD 142900-00-12

MOD 5029

<b>Zubehör</b>			
<b>Für monolithisches Glas</b>		<b>T</b>	
SELL OUT	205029-08	8	4
SELL OUT	205029-10	10	4
SELL OUT	205029-12	12	4

<b>Für laminiertes Glas</b>			
SELL OUT	205029-09	8,76	4
SELL OUT	205029-11	10,76	4
SELL OUT	205029-13	12,76	4
SELL OUT	205029-64	13,52	4





MOD 5500

 Q-railing

**Glashalter - MOD 5500**

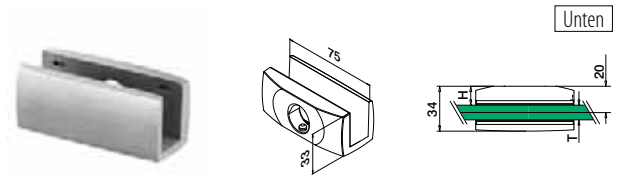
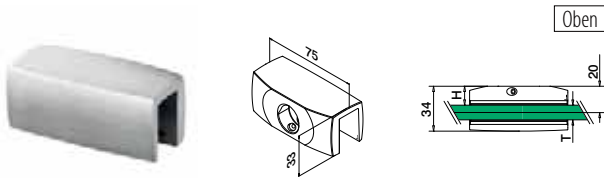

**MOD 5500**

V4A	<b>316</b>	Gebürstet		
	<b>OUTDOOR</b>		<b>T</b>	<b>H</b>
145500-01-12			Siehe T in MOD 5055	Siehe H in MOD 5055
				2



Internationaler Geschmacksmusterschutz

**MOD 5500**

V4A	<b>316</b>	Gebürstet		
	<b>OUTDOOR</b>		<b>T</b>	<b>H</b>
145500-02-12			Siehe T in MOD 5055	Siehe H in MOD 5055
				2



Internationaler Geschmacksmusterschutz

**Adapter für MOD 5500**

Für flaches Rohr

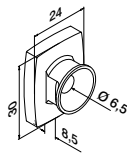

Für rundes Rohr

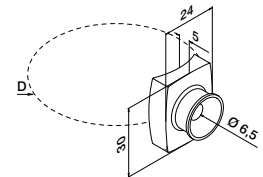

**MOD 0785**

V4A	<b>316</b>	Gebürstet		
	<b>OUTDOOR</b>			
140785-000-12		QS-16 474		4



**MOD 0785**

V4A	<b>316</b>	Gebürstet		
	<b>OUTDOOR</b>		<b>D</b>	
140785-042-12		QS-16 474	42,4	4
140785-048-12		QS-16 474	48,3	4



**Gummieinlagen**



1 Stück pro Glasklemme

**MOD 5055**

**Zubehör**

Für monolithisches Glas	<b>T</b>	<b>H</b>	
205055-08	8	15,5	2
205055-10	10	14,5	2
205055-12	12	13,5	2

Für laminiertes Glas

205055-08	8,76	15	2
205055-10	10,76	14,5	2
205055-54	11,52	14	2
205055-12	12,76	13,5	2
205055-64	13,52	13	2

**Q-INFO** MOD 0785

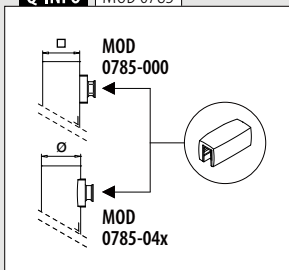

**Q-INFO** MOD 5500-02

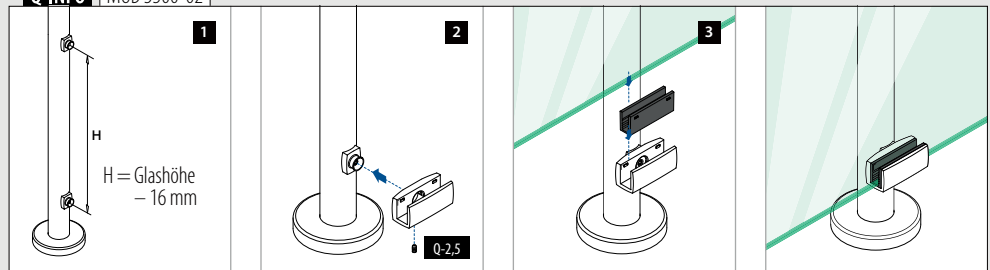

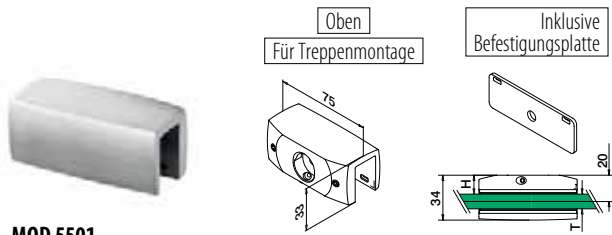

MOD 5501

V4A	316	Gebürstet		
<b>OUTDOOR</b>		<b>T</b>	<b>H</b>	
145501-01-12	Siehe T in MOD 5055		Siehe H in MOD 5055	2



Internationaler Geschmacksmusterschutz

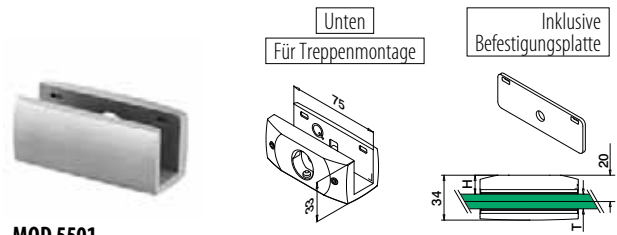

MOD 5501

V4A	316	Gebürstet		
<b>OUTDOOR</b>		<b>T</b>	<b>H</b>	
145501-02-12	Siehe T in MOD 5055		Siehe H in MOD 5055	2



Internationaler Geschmacksmusterschutz



MOD 0786

V4A	316	Gebürstet		
<b>OUTDOOR</b>				
140786-000-12	QS-16	474		2

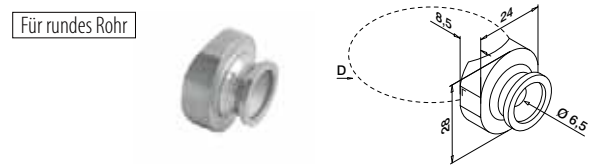

MOD 0786

V4A	316	Gebürstet		
<b>OUTDOOR</b>		<b>D</b>		
140786-042-12	42,4	QS-16	474	2
140786-048-12	48,3	QS-16	474	2

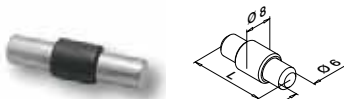

MOD 5015

<b>Zubehör</b>			
	<b>L</b>		
205015-25	25		4

Q-INFO MOD 5501

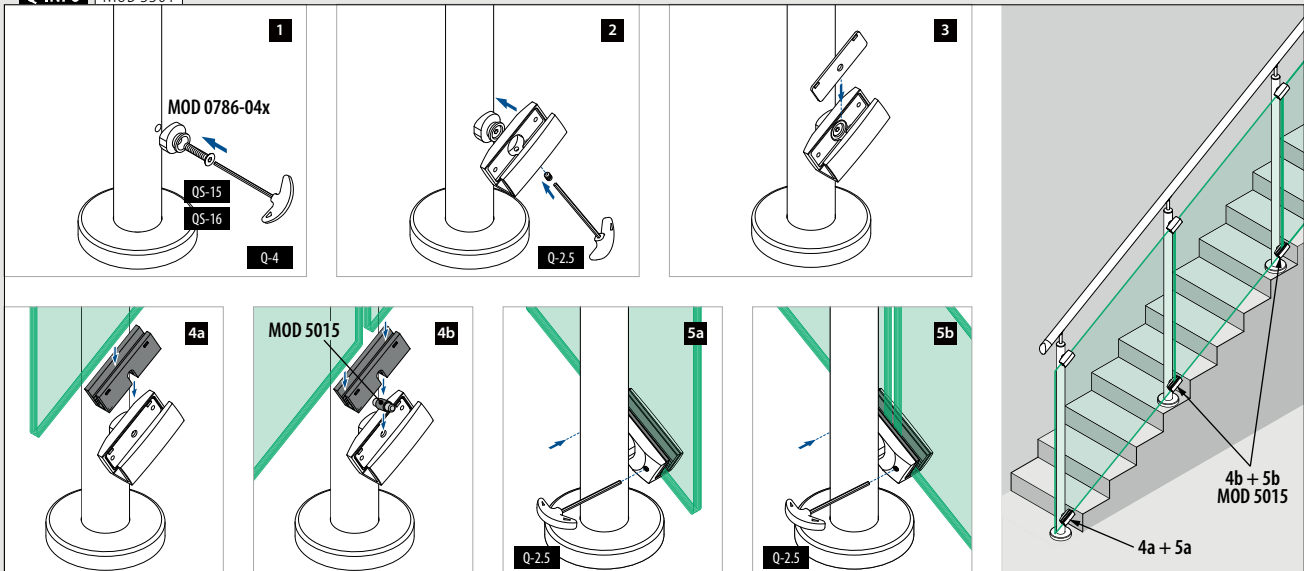

Glasverbinder - MOD 2870 / 2880 / 2890

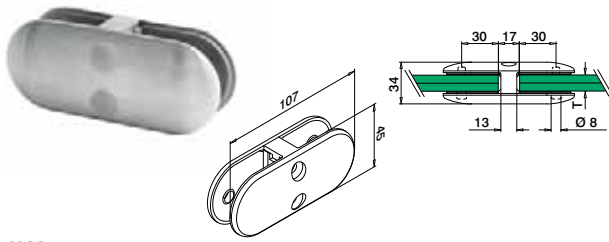

**MOD 2870**

V2A	<b>304</b>	Gebürstet		
	<b>INDOOR</b>	<b>T</b>		
	132870-13-12	Siehe T in MOD 5028	2	
V4A	<b>316</b>	Gebürstet		
	<b>OUTDOOR</b>			
	142870-13-12	Siehe T in MOD 5028	2	



Internationaler Geschmacksmusterschutz

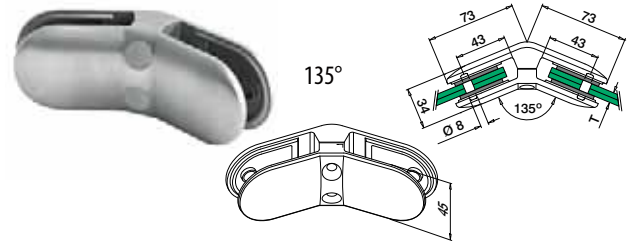

**MOD 2880**

V4A	<b>316</b>	Gebürstet		
	<b>OUTDOOR</b>	<b>T</b>		
	142880-13-12	Siehe T in MOD 5028	2	



Internationaler Geschmacksmusterschutz

Gummieinlagen für MOD 2870 / 2880 / 2890

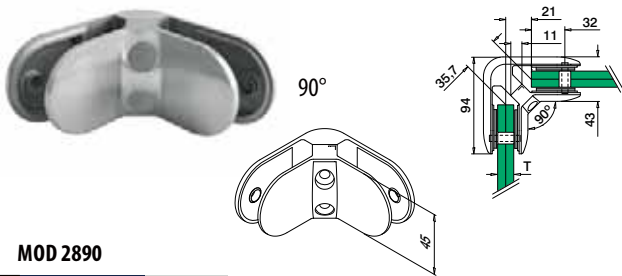

**MOD 2890**

V2A	<b>304</b>	Gebürstet		
	<b>INDOOR</b>	<b>T</b>		
	132890-13-12	Siehe T in MOD 5028	2	
V4A	<b>316</b>	Gebürstet		
	<b>OUTDOOR</b>			
	142890-13-12	Siehe T in MOD 5028	2	



Internationaler Geschmacksmusterschutz



4 Stück pro Glasverbinder

**MOD 5028**

**Zubehör**

<b>Für monolithisches Glas</b>		<b>T</b>	
205028-06	6	8	
205028-08	8	8	
205028-10	10	8	
205028-12	12	8	

**Für laminiertes Glas**

205028-09	8,76	8
205028-44	9,52	8
205028-11	10,76	8
205028-54	11,52	8
205028-13	12,76	8

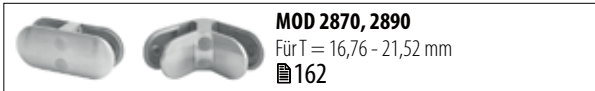

**Sicherungsstifte**

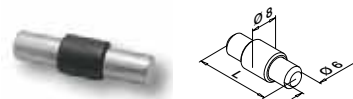

Optional verwendbar für MOD 2870 / 2880 / 2890

**MOD 5015**

**Zubehör**

	<b>L</b>	
205015-22	22	4

**Q-INFO** MOD 2870

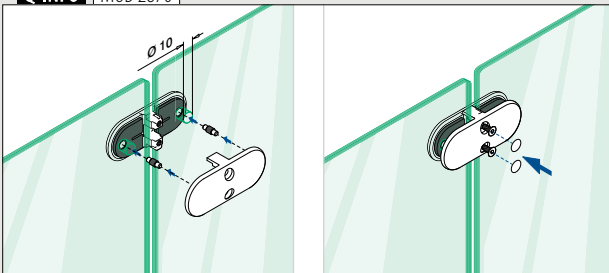

**Q-INFO** MOD 2880

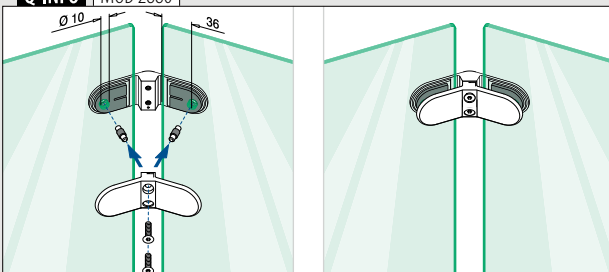

**Q-INFO** MOD 2890

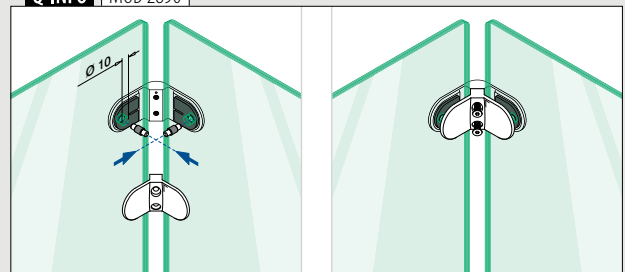

Glasverbinder - MOD 4270 / 4280 / 4290

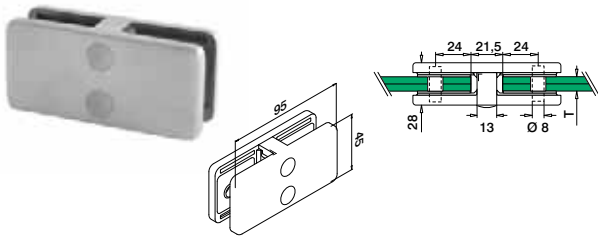

**MOD 4270**

V2A	<b>304</b>	Gebürstet		
	<b>INDOOR</b>	<b>T</b>		
	134270-13-12	Siehe T in MOD 5042		2

V4A	<b>316</b>	Gebürstet		
	<b>OUTDOOR</b>			
	144270-13-12	Siehe T in MOD 5042		2



Internationaler Geschmacksmusterschutz

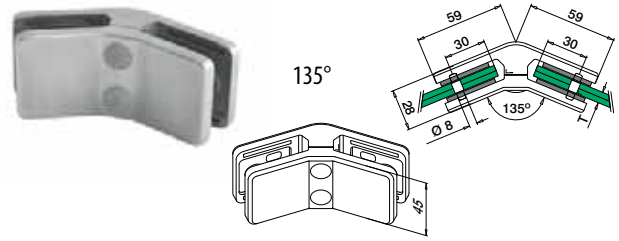

**MOD 4280**

V4A	<b>316</b>	Gebürstet		
	<b>OUTDOOR</b>	<b>T</b>		
	144280-13-12	Siehe T in MOD 5042		2



Internationaler Geschmacksmusterschutz

Gummieinlagen für MOD 4270 / 4280 / 4290

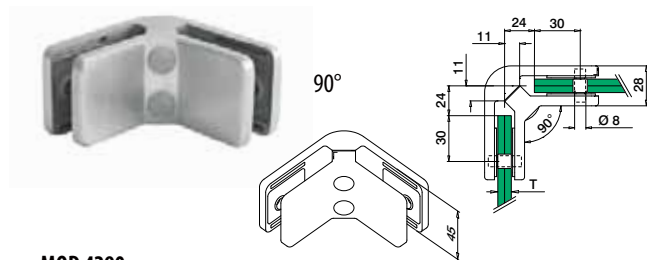

**MOD 4290**

V2A	<b>304</b>	Gebürstet		
	<b>INDOOR</b>	<b>T</b>		
	134290-13-12	Siehe T in MOD 5042		2

V4A	<b>316</b>	Gebürstet		
	<b>OUTDOOR</b>			
	144290-13-12	Siehe T in MOD 5042		2



4 Stück pro Glasverbinder

**MOD 5042**

Zubehör

Für monolithisches Glas	T	
205042-06	6	8
205042-08	8	8
205042-10	10	8
205042-12	12	8

Für laminiertes Glas

205042-07	6,76	8
205042-41	8,38	8
205042-09	8,76	8
205042-44	9,52	8
205042-11	10,76	8
205042-54	11,52	8
205042-13	12,76	8

Zubehör

Sicherungsstifte

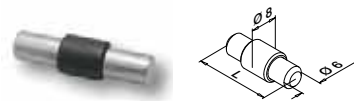

Optional verwendbar für MOD 4270 / 4280 / 4290

**MOD 5015**

Zubehör

	L	
205015-22	22	4

**Q-INFO** MOD 4270

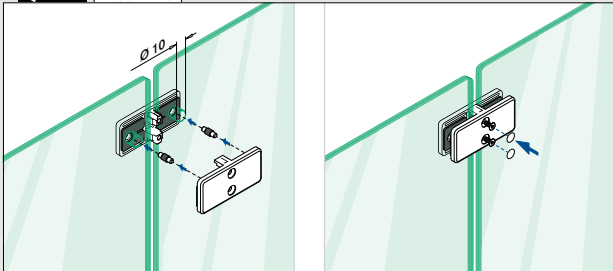

**Q-INFO** MOD 4280

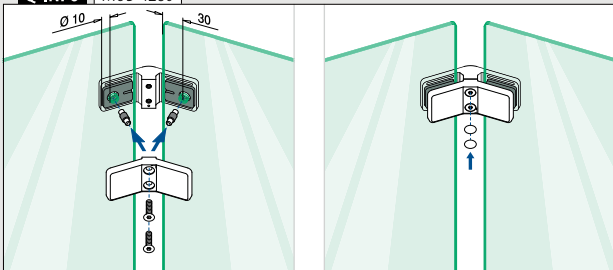

**Q-INFO** MOD 4290

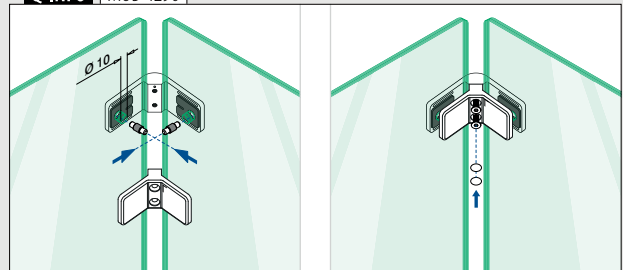



Glas - Glas

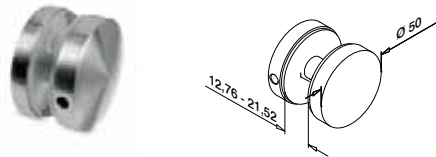

**MOD 0742**

<b>V2A</b>	<b>304</b>	Gebürstet
<b>INDOOR</b>		
130742-12		2
<b>V4A</b>	<b>316</b>	Gebürstet
<b>OUTDOOR</b>		
140742-12		2
<b>V4A</b>	<b>316</b>	Hochglanzpoliert
<b>OUTDOOR</b>		
140742-10		2



Türriegel

Für flaches Rohr

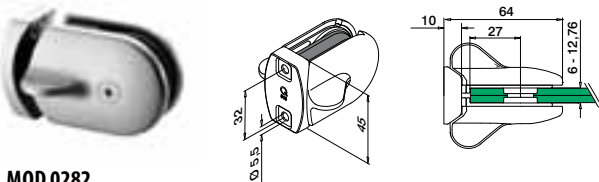

**MOD 0282**

<b>V4A</b>	<b>316</b>	Gebürstet
<b>OUTDOOR</b>		
140282-000	QS-13 474	1



Internationaler Geschmacksmusterschutz

Für rundes Rohr

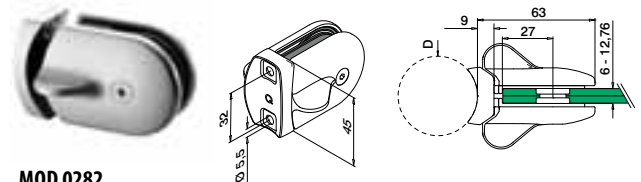

**MOD 0282**

<b>V4A</b>	<b>316</b>	Gebürstet	<b>D</b>
<b>OUTDOOR</b>			
140282-042	42,4	QS-13 474	1
140282-048	48,3	QS-13 474	1



Internationaler Geschmacksmusterschutz

Glas - Glas

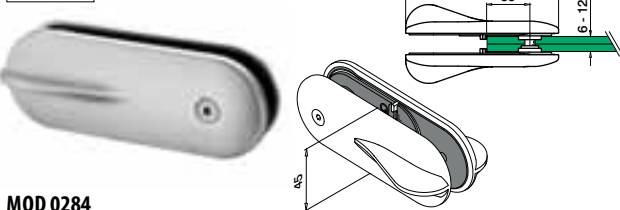

**MOD 0284**

<b>V4A</b>	<b>316</b>	Gebürstet
<b>OUTDOOR</b>		
140284		1



Internationaler Geschmacksmusterschutz

Bitte bestellen Sie Befestigungsmaterial separat.

**Q-INFO** 304 316

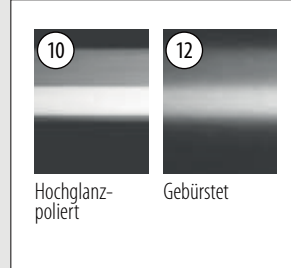

**Q-INFO** MOD 0742

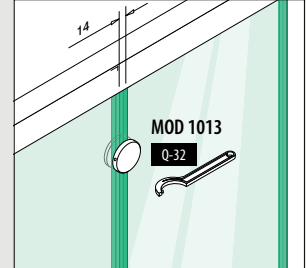

**Q-INFO** MOD 0284

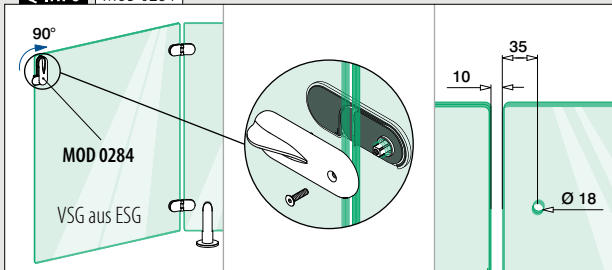

**Q-INFO** MOD 0282

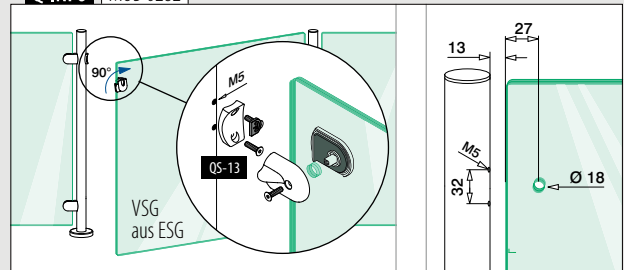

Scharniere

Für flaches Rohr

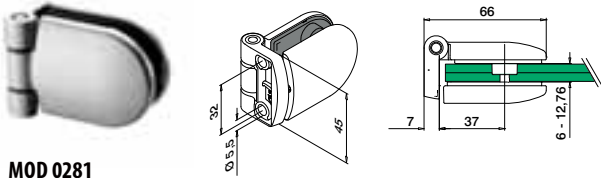

MOD 0281

Für rundes Rohr

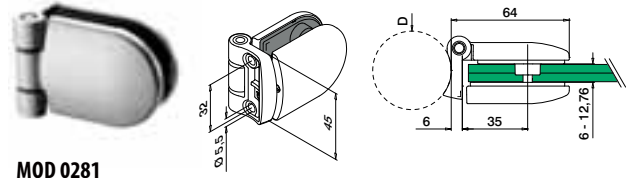

MOD 0281

V4A	316	Gebürstet	
<b>OUTDOOR</b>			
140281-000	QS-13	474	2



Internationaler Geschmacksmusterschutz

V4A	316	Gebürstet	
<b>OUTDOOR</b>			
140281-042	D	QS-13	474
140281-048	48,3	QS-13	474



Internationaler Geschmacksmusterschutz

Glas - Glas

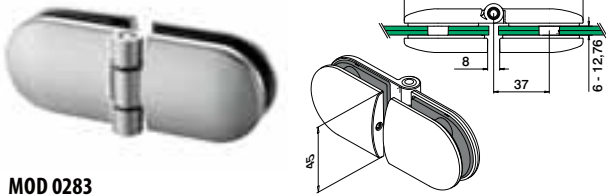

MOD 0283

V4A	316	Gebürstet	
<b>OUTDOOR</b>			
140283			2



Internationaler Geschmacksmusterschutz

V4A Q-INFO MOD 0283

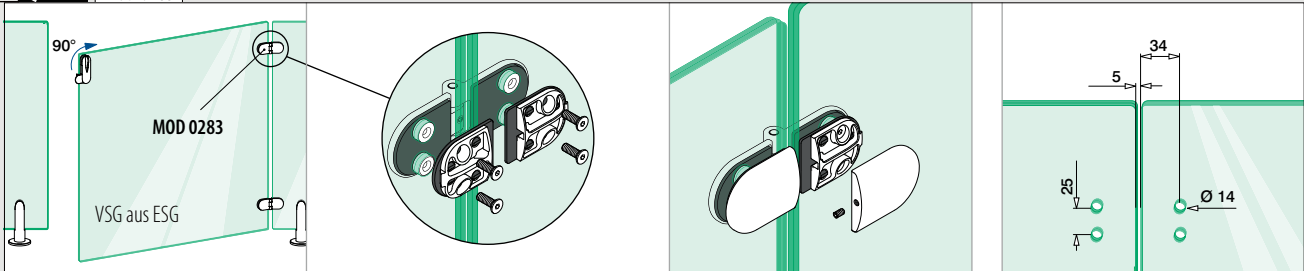

Q-INFO MOD 0281

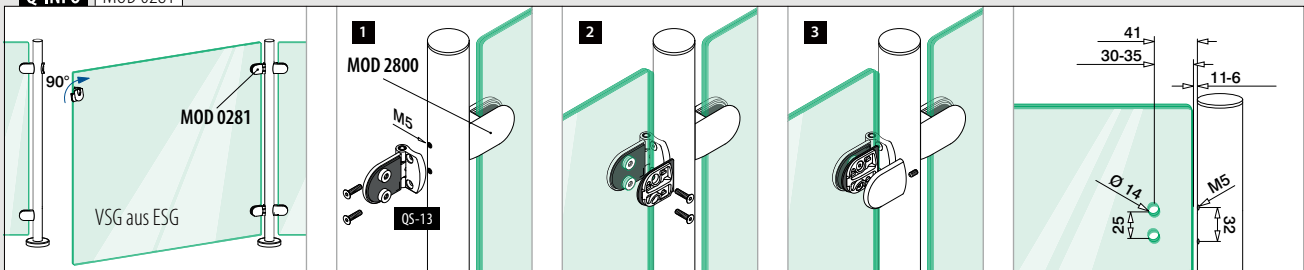



MOD 0754

Für flaches Rohr

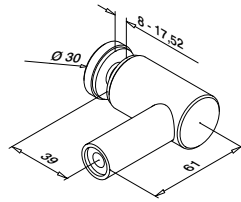

MOD 0754

V4A	316	Gebürstet		
<b>OUTDOOR</b>				
140754-000-12	QS-30	474	4	



Internationaler Geschmacksmusterschutz

Für rundes Rohr

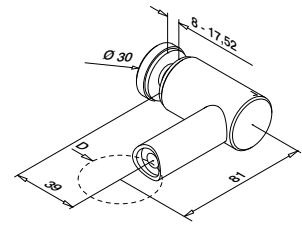

MOD 0754

V4A	316	Gebürstet		
<b>OUTDOOR</b>		<b>D</b>		
140754-042-12	42,4	QS-30	474	4
140754-048-12	48,3	QS-30	474	4



Internationaler Geschmacksmusterschutz

Bitte bestellen Sie Befestigungsmaterial separat.

Q-INFO

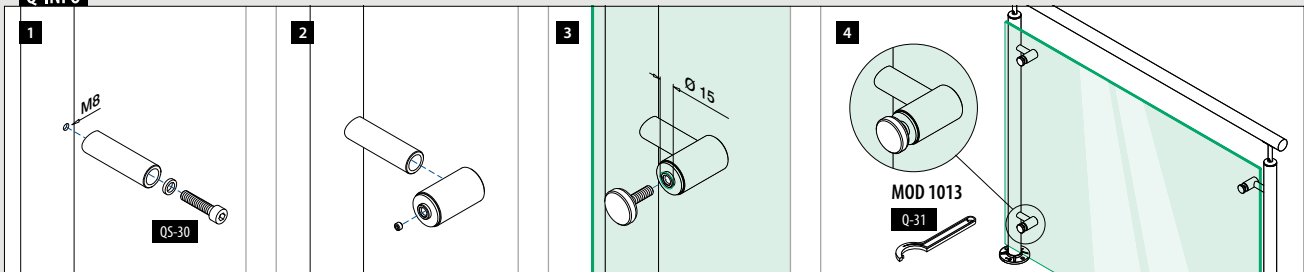

Für flaches Rohr



**MOD 0746**

V2A	304	Gebürstet	INDOOR	H	L	L1	
			130746-015-12	15	50	10 - 22	4
			130746-020-12	20	60	14 - 26	4
			130746-030-12	30	70	14 - 26	4
			130746-040-12	40	80	14 - 26	4
			130746-050-12	50	90	14 - 26	4

V4A	316	Gebürstet	OUTDOOR	H	L	L1	
			140746-015-12	15	50	10 - 22	4

V4A	316	Hochglanzpoliert	OUTDOOR	H	L	L1	
SELL OUT			140746-015-10	15	50	10 - 22	4

**Zinkdruckguss**  
INDOOR

SELL OUT	100746-...		15	50	10 - 22	4	
----------	------------	--	----	----	---------	---	--



Für rundes Rohr



**MOD 0746**

V2A	304	Gebürstet	INDOOR	D	L1	
SELL OUT			130746-033-12	33,7	10 - 22	4
SELL OUT			130746-042-12	42,4	10 - 22	4
SELL OUT			130746-048-12	48,3	10 - 22	4

V4A	316	Gebürstet	OUTDOOR	D	L1	
SELL OUT			140746-033-12	33,7	10 - 22	4
SELL OUT			140746-042-12	42,4	10 - 22	4
SELL OUT			140746-048-12	48,3	10 - 22	4
SELL OUT			140746-060-12	60,3	10 - 22	4



**MOD 0740**

V2A	304	Gebürstet	INDOOR	
SELL OUT			130740-12	4

V4A	316	Gebürstet	OUTDOOR	
			140740-12	4

V4A	316	Hochglanzpoliert	OUTDOOR	
SELL OUT			140740-10	4



**MOD 0755**

V2A	304	Gebürstet	INDOOR	Ø	
SELL OUT			130755-16	16	4

V4A	316	Gebürstet	OUTDOOR	Ø	
SELL OUT			140755-12	12	4



**Q-INFO** 316

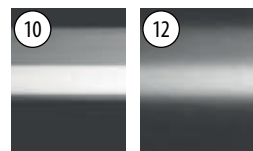

Hochglanzpoliert Gebürstet

**Q-INFO** MOD 0746

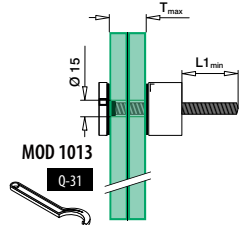

MOD 1013 Q-31

**Q-INFO** MOD 0755

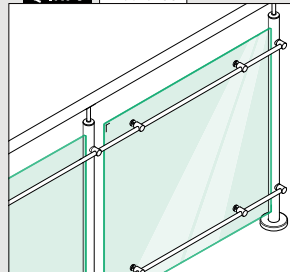

**Q-INFO** MOD 0755

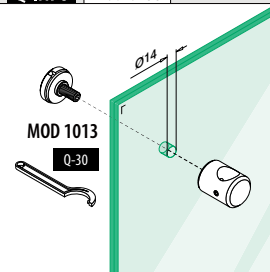

MOD 1013 Q-30

**Q-INFO** Zinkdruckguss MOD 0746 Oberflächen

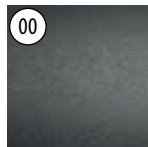

00 Roh

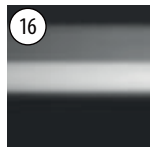

16 Mattverchromt



19 INDOOR Edelstahleffekt



32 RAL 9016 Pulverbeschichtet INDOOR Weiß, satiniert, glatt



89 RAL 9005 Pulverbeschichtet INDOOR Schwarz, matt, glatt

**Q-INFO**



**MOD 5030** 477  
Zusätzliche Gummieinlagen für Glasadapter



Für flaches Rohr

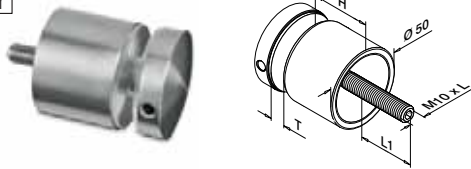

**MOD 0747**

V2A	304	Gebürstet	INDOOR	H	T	L	L1	
			130747-010-12	10	8 - 17,52	50	11 - 22	2
			130747-020-12	20	8 - 25,52	70	13 - 31	2
			130747-030-12	30	8 - 25,52	80	13 - 31	2
			130747-040-12	40	8 - 17,52	80	11 - 22	2
			130747-050-12	50	8 - 17,52	90	11 - 22	2

V2A	304	Black Line	INDOOR	H	T	L	L1	
NEW			130747-010-82	10	8 - 17,52	50	11 - 22	2
NEW			130747-030-82	30	8 - 25,52	80	13 - 31	2

V4A	316	Gebürstet	OUTDOOR	H	T	L	L1	
			140747-010-12	10	8 - 17,52	50	11 - 22	2
			140747-020-12	20	8 - 25,52	70	13 - 31	2
			140747-030-12	30	8 - 25,52	80	13 - 31	2
			140747-040-12	40	8 - 17,52	80	11 - 21	2
			140747-050-12	50	8 - 17,52	90	11 - 21	2

V4A	316	Hochglanzpoliert	OUTDOOR	H	T	L	L1	
			140747-030-10	30	8 - 25,52	80	13 - 31	2

Zinkdruckguss	Roh	INDOOR	H	T	L	L1		
SELL OUT			100747-00	10	8 - 17,52	50	11 - 22	2

Zinkdruckguss	Edelstahleffekt	OUTDOOR	H	T	L	L1		
SELL OUT			100747-20	10	8 - 17,52	50	11 - 22	2



Für rundes Rohr

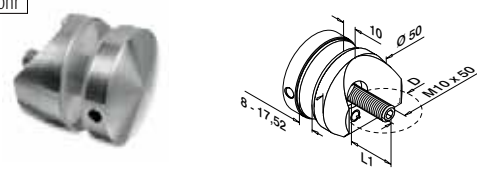

**MOD 1747**

V2A	304	Gebürstet	INDOOR	D	L1	
SELL OUT			131747-010-42-12	42,4	10 - 20	2
			131747-010-48-12	48,3	10 - 20	2

V4A	316	Gebürstet	OUTDOOR	D	L1	
			141747-010-42-12	42,4	10 - 20	2



**Q-INFO** Zinkdruckguss

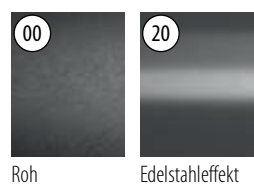

Roh Edelstahleffekt

**Q-INFO**



Artikel mit .00-Ausführung können pulverbeschichtet werden.

**Q-INFO** 304 316



Hochglanzpoliert Gebürstet Pulverbeschichtet Schwarz, matt, strukturiert

SELL OUT Nur solange der Vorrat reicht.

**Q-INFO** MOD 0747

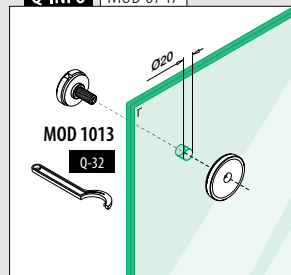

**Q-INFO** MOD 1747

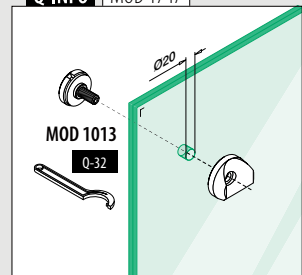







# 6

# ZUBEHÖR

Übersicht Q-Schrauben / Q-Anker .....	458
Finden Sie den richtigen Anker .....	459 - 465
Anker .....	466 - 469
Schrauben .....	470 - 474
Befestigungsmaterial .....	475 - 476
Ersatzmaterial für Glasklemmen/Glasadapter .....	477
Bohren und Gewindeschneiden .....	478 - 479
Montagezubehör .....	480 - 483
Pflege und Reinigung .....	484
Werkzeug .....	485 - 487
Symbolverzeichnis .....	489

Schrauben schneller bestellen. Eine Zusammenfassung der Seiten 466 - 482.

QS	#		
QS-1	230205-050	50	473
QS-2	240205-050	50	473
QS-3	230200-760	50	473
QS-4	240200-760	50	473
QS-5	230210-025	50	473
QS-6	240210-025	50	473
QS-7	230210-038	50	473
QS-8	230230-025	50	473
QS-9	240230-025	50	473
QS-10	230690-516	50	474
QS-11	240690-516	50	474
QS-12	230670-520	50	474
QS-13	240670-520	50	474
QS-14	230670-620	50	474
QS-15	230670-625	50	474
QS-16	240670-625	50	474
QS-17	230670-630	50	474
QS-18	240670-630	50	474
QS-19	230670-825	50	474
QS-20	240670-825	50	474
QS-21	230670-840	50	474
QS-22	240670-840	50	474
QS-23	230680-620	50	474
QS-24	230680-635	50	474
QS-25	230680-660	50	474
QS-26	230680-820	50	474
QS-27	240680-820	50	474
QS-28	250680-820	50	474
QS-29	230680-835	50	474
QS-30	240680-835	50	474
QS-32	244010-212	10	466
QS-33	254010-212	10	466
QS-34	244110-875	10	469
QS-35	254110-875	10	469
QS-36	254210-212	25	469
QS-38	230800-616	50	476
QS-39	230800-817	50	476
QS-40	230800-121	50	476
QS-41	240670-616	50	477
QS-42	240670-620	50	477
QS-43	250670-616	50	477
QS-44	250670-620	50	477
QS-45	240681	50	476
QS-46	250681	50	476
QS-47	230681	50	476
QS-48	230670-612	50	474
QS-49	230211-340	50	473
QS-50	240210-038	50	473
QS-51	200842	50	482
QS-53	240680-620	50	474
QS-54	230680-645	50	474
QS-55	200851-827	50	472
QS-56	230230-038	50	473
QS-57	240230-038	50	473
QS-58	244110-190	10	469
QS-59	254110-190	10	469
QS-60	244010-217	10	466
QS-62	244010-880	10	466
QS-63	254010-880	10	466
QS-64	244010-185	10	466
QS-65	254010-185	10	466
QS-66	250803-120	50	480
QS-67	230680-140	50	474
QS-69	230803-818	50	480
QS-70	240680-645	50	474
QS-71	240680-660	50	474
QS-72	240680-140	50	474
QS-74	240670-240	50	474
QS-80	240800-616	50	476
QS-81	240800-817	50	476
QS-82	240800-121	50	476
QS-83	230690-616	50	474
QS-84	240690-616	50	474
QS-85	230205-090	50	473
QS-86	240205-090	50	473
QS-87	200841-635	100	472
QS-89	240670-612	50	474
QS-90	240400-505	50	474
QS-91	230400-505	50	474
QS-92	240400-610	50	474
QS-93	240490-506	50	474
QS-94	230490-506	50	474
QS-200	230240-412	50	473
QS-202	230690-510	50	474
QS-203	240690-510	50	474

QS	#		
QS-205	240670-608	50	474
QS-207	244510-290	10	467
QS-208	254510-290	10	467
QS-211	244510-212	10	467
QS-212	254510-212	10	467
QS-213	244260-180	50	470
QS-214	244250-180	50	470
QS-215	240663-224	50	475
QS-216	250663-224	50	475
QS-217	240664-220	50	475
QS-219	240661-235	50	475
QS-221	240662-230	50	475
QS-222	250662-230	50	475
QS-223	240661-230	50	475
QS-224	250661-230	50	475
QS-225	240661-245	50	475
QS-250	250260-008	50	471
QS-251	250260-012	50	471
QS-255	250250-808	50	471
QS-256	250250-812	50	471
QS-258	250250-012	50	471
QS-261	240690-608	50	474
QS-264	230250-608	50	471
QS-265	230250-610	50	471
QS-266	240915-550	50	471
QS-267	240212-438	50	473
QS-268	240212-413	50	473
QS-270	254410-811	10	466
QS-271	244410-811	10	466
QS-272	254410-113	10	466
QS-273	244410-113	10	466
QS-274	254410-215	10	466
QS-275	244410-215	10	466
QS-276	254410-217	10	466
QS-277	244410-217	10	466
QS-281	254410-820	10	466
QS-282	244410-820	10	466
QS-284	254410-226	10	466
QS-285	244410-226	10	466
QS-286	240665-232	50	470
QS-287	240666-816	50	475
QS-288	230491-850	50	472
QS-289	240651-208	50	475
QS-290	250251-010	25	471
QS-503	230210-060	50	473
QS-504	240210-060	50	473
QS-505	254510-210	10	467
QS-507	254010-217	10	466
QS-512	200203	50	480
QS-513	240650-865	50	475
QS-514	230650-865	50	475
QS-515	240650-108	50	475
QS-516	240650-210	50	475
QS-517	230650-108	50	475
QS-518	230650-210	50	475
QS-519	244210-212	25	469
QS-520	244510-180	10	467
QS-521	254510-180	10	467
QS-528	254510-875	10	467
QS-529	244510-875	10	467
QS-530	240670-135	50	474
QS-531	230670-135	50	474
QS-532	230670-130	50	474
QS-533	240670-130	50	474
QS-549	244010-213	10	466
QS-551	230680-240	50	474
QS-555	200841-160	50	472
QS-556	240200-890	50	473
QS-557	244519-290	10	467
QS-558	254519-290	10	467
QS-559	244519-210	10	467
QS-560	244220-285	25	469
QS-561	254220-285	25	469
QS-562	244220-211	25	469
QS-563	254220-211	25	469
QS-570	200843-008	25	472
QS-571	254300-110	50	470
QS-572	244300-110	50	470
QS-573	244300-112	50	470
QS-574	254310-110	50	470
QS-575	244310-110	50	470
QS-576	254310-112	50	470
QS-577	244310-112	50	470
QS-578	244310-870	50	470
QS-579	230805-665	2	471

# FINDEN SIE DEN RICHTIGEN ANKER FÜR IHR PROJEKT

Bitte prüfen Sie vor dem Kauf die entsprechenden lokalen Normen bezüglich der Verwendung von Anker.













Finden Sie alle Informationen zu Q-pac online:



<https://q-ne.ws/QPac23>









Die Anker in dieser Übersicht sind NICHT berechnet oder getestet, sondern lediglich eine Empfehlung basierend auf dem Q-railing Sortiment. Andere Anker und Optionen sind möglich. Unsere Services, wie Q-pac und Ankertabellen, helfen Ihnen bei der Wahl der richtigen Anker für Ihre Projekte. Bei Fragen kontaktieren Sie gerne auch Ihren Verkaufsberater.

## EASY GLASS® SMART / SMART+ / PRIME













Montage	t (mm)	Anker	QS	Typ	Verwendung	Schraube / Bolzen	QS	Typ	Verwendung			
 <b>MOD 8210 / 8410</b> <b>MOD 8310</b>	7 / 8,5	Chemisch	<b>FÜR BETON</b>				<b>FÜR STAHL</b>					
			QS-276	QVMU-A M12x175	INDOOR		466	QS-224	M12 x 30	INDOOR	475	
			QS-277	QVMU-A M12x175 A4	OUTDOOR		466	+ QS-216	Für M12	INDOOR	475	
			QS-207	QVMZ-IG 90 M12 A4	OUTDOOR		467	QS-223	M12 x 30	OUTDOOR	475	
			+ QS-225	M12 x 45	OUTDOOR		475	+ QS-215	Für M12	OUTDOOR	475	
		+ QS-215	Für M12	OUTDOOR	475		QS-225	M12 x 45	OUTDOOR	475		
		Mechanisch	<b>FÜR STAHL</b>					<b>FÜR HOLZ</b>				
			QS-574	QBSZ SU 10x100	INDOOR			470	QS-258	10 x 120	INDOOR	471
			QS-575	QBSZ SU 10x100 A4	OUTDOOR			470	QS-290	10 x 100	OUTDOOR	471
			QS-576	QBSZ SU 10x120	INDOOR			470				
			QS-577	QBSZ SU 10x120 A4	OUTDOOR			470				
			QS-560	QSZ 12/10 A4	OUTDOOR			469				
			QS-561	QSZ-S 12/10	INDOOR			469				
			QS-562	QSZ 12/30 A4	OUTDOOR			469				
			QS-563	QSZ-S 12/30	INDOOR			469				
 <b>MOD 8220 / 8420</b>	15 / 20		Chemisch	<b>FÜR BETON</b>					<b>FÜR STAHL</b>			
		QS-276		QVMU-A M12x175	INDOOR	466	QS-225		M12 x 45	OUTDOOR	475	
		QS-277		QVMU-A M12x175 A4	OUTDOOR	466	+ QS-215		Für M12	OUTDOOR	475	
		QS-207		QVMZ-IG 90 M12 A4	OUTDOOR	467						
		+ QS-225		M12 x 45	OUTDOOR	475	<b>FÜR HOLZ</b>					
		+ QS-215	Für M12	OUTDOOR	475	QS-258	10 x 120		INDOOR	471		
		Mechanisch	QS-290	10 x 100	OUTDOOR	471						
			QS-562	QSZ 12/30 A4	OUTDOOR	469						
			QS-563	QSZ-S 12/30	INDOOR	469						
			QS-576	QBSZ SU 10x120	INDOOR	470						
QS-577	QBSZ SU 10x120 A4		OUTDOOR	470								
 <b>MOD 8230 / 8430</b> <b>MOD 8330</b>	4 / 5	Chemisch	<b>FÜR BETON</b>				<b>FÜR STAHL</b>					
			QS-207	QVMZ-IG 90 M12 A4	OUTDOOR		467	QS-224	M12 x 30	INDOOR	475	
			+ QS-225	M12 x 45	OUTDOOR		475	+ QS-216	Für M12	INDOOR	475	
			+ QS-215	Für M12	OUTDOOR		475	QS-223	M12 x 30	OUTDOOR	475	
								+ QS-215	Für M12	OUTDOOR	475	
		Mechanisch	<b>FÜR STAHL</b>					<b>FÜR HOLZ</b>				
			QS-571	QBSZ SK 10x100	INDOOR			470	QS-225	M12 x 45	OUTDOOR	475
			+ QS-286	Für QBSZ SK 10	INDOOR			470	+ QS-215	Für M12	OUTDOOR	475
			QS-572	QBSZ SK 10x100 A4	OUTDOOR			470				
			+ QS-286	Für QBSZ SK 10	OUTDOOR			470	QS-258	10 x 120	INDOOR	471
			QS-573	QBSZ SK 10x120 A4	OUTDOOR			470	QS-290	10 x 100	OUTDOOR	471
			+ QS-286	Für QBSZ SK 10	OUTDOOR			470				
			QS-560	QSZ 12/10 A4	OUTDOOR			469				
			QS-561	QSZ-S 12/10	INDOOR			469				
			QS-562	QSZ 12/30 A4	OUTDOOR			469				
QS-563	QSZ-S 12/30	INDOOR	469									
 <b>MOD 8240 / 8440</b>	5 / 5	Chemisch	<b>FÜR BETON</b>				<b>FÜR STAHL</b>					
			QS-276	QVMU-A M12x175	INDOOR		466	QS-224	M12 x 30	INDOOR	475	
			QS-277	QVMU-A M12x175 A4	OUTDOOR		466	+ QS-216	Für M12	INDOOR	475	
			QS-207	QVMZ-IG 90 M12 A4	OUTDOOR		467	QS-223	M12 x 30	OUTDOOR	475	
			+ QS-225	M12 x 45	OUTDOOR		475	+ QS-215	Für M12	OUTDOOR	475	
		+ QS-215	Für M12	OUTDOOR	475		QS-225	M12 x 45	OUTDOOR	475		
		Mechanisch	<b>FÜR STAHL</b>					<b>FÜR HOLZ</b>				
			QS-574	QBSZ SU 10x100	INDOOR			470	QS-258	10 x 120	INDOOR	471
			QS-575	QBSZ SU 10x100 A4	OUTDOOR			470	QS-290	10 x 100	OUTDOOR	471
			QS-576	QBSZ SU 10x120	INDOOR			470				
			QS-577	QBSZ SU 10x120 A4	OUTDOOR			470				
			QS-560	QSZ 12/10 A4	OUTDOOR			469				
			QS-561	QSZ-S 12/10	INDOOR			469				







## EASY GLASS® SLIM

Montage	t (mm)	Anker	QS	Typ	Verwendung	Schraube / Bolzen	QS	Typ	Verwendung		
 <b>MOD 8010</b>	12,5		FÜR BETON				FÜR STAHL				
			QS-36	Q SZ-SK 12/50	INDOOR		469	QS-531	M10 x 35	INDOOR	474
			QS-519	Q SZ-SK 12/50 A4	OUTDOOR		469	QS-530	M10 x 35	OUTDOOR	474
			QS-571	Q BSZ SK 10x100	INDOOR		470	FÜR HOLZ			
			QS-572	Q BSZ SK 10x100 A4	OUTDOOR		470	QS-251	10 x 120	INDOOR	471
QS-573	Q BSZ SK 10x120 A4	OUTDOOR	470								
 <b>MOD 8020</b>	10,5		FÜR BETON				FÜR STAHL				
			QS-276	Q VMU-A M12x175	INDOOR		466	QS-223	M12 x 30	OUTDOOR	475
			QS-277	Q VMU-A M12x175 A4	OUTDOOR		466	+ QS-215	Für M12	OUTDOOR	475
			QS-207	Q VMZ-IG 90 M12 A4	OUTDOOR		467	QS-225	M12 x 45	OUTDOOR	475
			+ QS-225	M12 x 45	OUTDOOR		475	+ QS-215	Für M12	OUTDOOR	475
		+ QS-215	Für M12	OUTDOOR	475	FÜR HOLZ					
		QS-562	Q SZ 12/30 A4	OUTDOOR	469	QS-258	10 x 120	INDOOR	471		
		QS-563	Q SZ-S 12/30	INDOOR	469	QS-290	10 x 100	OUTDOOR	471		
		QS-576	Q BSZ SU 10x120	INDOOR	470						
		QS-577	Q BSZ SU 10x120 A4	OUTDOOR	470						
 <b>MOD 8030</b>	7		FÜR BETON				FÜR STAHL				
			QS-36	Q SZ-SK 12/50	INDOOR		469	QS-74	M12 x 40	OUTDOOR	474
			QS-519	Q SZ-SK 12/50 A4	OUTDOOR		469	FÜR HOLZ			
			QS-571	Q BSZ SK 10x100	INDOOR		470	QS-250	10 x 80	INDOOR	471
			QS-572	Q BSZ SK 10x100 A4	OUTDOOR		470	QS-251	10 x 120	INDOOR	471
QS-573	Q BSZ SK 10x120 A4	OUTDOOR	470								



## EASY GLASS® PRO

Montage	t (mm)	Anker	QS	Typ	Verwendung	Schraube / Bolzen	QS	Typ	Verwendung		
 <b>MOD 8110</b>	7,5		FÜR BETON				FÜR STAHL				
			QS-558	Q VMZ-IG 90 M12	INDOOR		467	QS-222	M12 x 30	INDOOR	475
			QS-557	Q VMZ-IG 90 M12 A4	OUTDOOR		470	+ QS-217	Für M12	INDOOR	475
			QS-574	Q BSZ SU 10x100	INDOOR		470	QS-221	M12 x 30	OUTDOOR	475
			QS-575	Q BSZ SU 10x100 A4	OUTDOOR		470	+ QS-217	Für M12	OUTDOOR	475
		QS-576	Q BSZ SU 10x120	INDOOR	470	FÜR HOLZ					
		QS-577	Q BSZ SU 10x120 A4	OUTDOOR	470	QS-258	10 x 120	INDOOR	471		
		QS-560	Q SZ 12/10 A4	OUTDOOR	469	QS-290	10 x 100	OUTDOOR	471		
		QS-561	Q SZ-S 12/10	INDOOR	469						
		 <b>MOD 8120</b>	12		FÜR BETON				FÜR STAHL		
QS-276	Q VMU-A M12x175				INDOOR	466	QS-219		M12 x 35	OUTDOOR	475
QS-277	Q VMU-A M12x175 A4				OUTDOOR	466	+ QS-215		Für M12	OUTDOOR	475
QS-207	Q VMZ-IG 90 M12 A4				OUTDOOR	467	QS-225		M12 x 45	OUTDOOR	475
+ QS-225	M12 x 45				OUTDOOR	475	+ QS-215		Für M12	OUTDOOR	475
+ QS-215	Für M12			OUTDOOR	475	FÜR HOLZ					
QS-562	Q SZ 12/30 A4			OUTDOOR	469	QS-258	10 x 120	INDOOR	471		
QS-563	Q SZ-S 12/30			INDOOR	469	QS-290	10 x 100	OUTDOOR	471		
QS-576	Q BSZ SU 10x120			INDOOR	470						
QS-577	Q BSZ SU 10x120 A4			OUTDOOR	470						
 <b>MOD 8130 / 8150</b>	5,5 / 5,5		FÜR BETON				FÜR STAHL				
			QS-558	Q VMZ-IG 90 M12	INDOOR		467	QS-222	M12 x 30	INDOOR	475
			QS-557	Q VMZ-IG 90 M12 A4	OUTDOOR		470	+ QS-217	Für M12	INDOOR	475
			QS-560	Q SZ 12/10 A4	OUTDOOR		469	QS-221	M12 x 30	OUTDOOR	475
			QS-561	Q SZ-S 12/10	INDOOR		469	+ QS-217	Für M12	OUTDOOR	475
				FÜR HOLZ							
QS-258	10 x 120	INDOOR	471	QS-290	10 x 100	OUTDOOR	471				
 <b>MOD 8140</b>	4,5		FÜR BETON				FÜR STAHL				
			QS-558	Q VMZ-IG 90 M12	INDOOR		467	QS-222	M12 x 30	INDOOR	475
			QS-557	Q VMZ-IG 90 M12 A4	OUTDOOR		470	+ QS-217	Für M12	INDOOR	475
			QS-574	Q BSZ SU 10x100	INDOOR		470	QS-551	M12 x 40	INDOOR	474
			QS-575	Q BSZ SU 10x100 A4	OUTDOOR		470	+ QS-217	Für M12	INDOOR	475
		QS-576	Q BSZ SU 10x120	INDOOR	470	QS-221	M12 x 30	OUTDOOR	475		
		QS-577	Q BSZ SU 10x120 A4	OUTDOOR	470	+ QS-217	Für M12	OUTDOOR	475		
		QS-560	Q SZ 12/10 A4	OUTDOOR	469	FÜR HOLZ					
		QS-561	Q SZ-S 12/10	INDOOR	469	QS-258	10 x 120	INDOOR	471		
						QS-290	10 x 100	OUTDOOR	471		



## EASY GLASS® MAX / STRONG

Montage	t (mm)	Anker	QS	Typ	Verwendung	Schraube / Bolzen	QS	Typ	Verwendung	
 <b>MOD 8510</b> <b>MOD 8610</b>	9,5	Chemisch	FÜR BETON					FÜR STAHL		
			QS-208	Q VMZ-IG 90 M12	INDOOR			467	QS-224	M12 x 30
			+ QS-224	M12 x 30	INDOOR	475	+ QS-216	Für M12	INDOOR	475
			+ QS-216	Für M12	INDOOR	475	QS-223	M12 x 30	OUTDOOR	475
			QS-207	Q VMZ-IG 90 M12 A4	OUTDOOR	467	+ QS-215	Für M12	OUTDOOR	475
			+ QS-219	M12 x 35	OUTDOOR	475	QS-225	M12 x 45	OUTDOOR	475
			+ QS-215	Für M12	OUTDOOR	475	+ QS-215	Für M12	OUTDOOR	475
 <b>MOD 8520</b>	9,5	Chemisch	FÜR BETON					FÜR STAHL		
			QS-276	Q VMU-A M12x175	INDOOR			466	QS-225	M12 x 45
			QS-277	Q VMU-A M12x175 A4	OUTDOOR	466	+ QS-215	Für M12	OUTDOOR	475
			QS-207	Q VMZ-IG 90 M12 A4	OUTDOOR	467				
			+ QS-225	M12 x 45	OUTDOOR	475				
			+ QS-215	Für M12	OUTDOOR	475				
 <b>MOD 8530</b> <b>MOD 8630</b>	26,5	Chemisch	FÜR BETON					FÜR STAHL		
			QS-208	Q VMZ-IG 90 M12	INDOOR			467	QS-224	M12 x 30
			+ QS-224	M12 x 30	INDOOR	475	+ QS-216	Für M12	INDOOR	475
			+ QS-216	Für M12	INDOOR	475	QS-223	M12 x 30	OUTDOOR	475
			QS-207	Q VMZ-IG 90 M12 A4	OUTDOOR	467	+ QS-215	Für M12	OUTDOOR	475
			+ QS-219	M12 x 35	OUTDOOR	475	QS-225	M12 x 45	OUTDOOR	475
			+ QS-215	Für M12	OUTDOOR	475	+ QS-215	Für M12	OUTDOOR	475
 <b>MOD 8540</b>	8	Chemisch	FÜR BETON					FÜR STAHL		
			QS-276	Q VMU-A M12x175	INDOOR			466	QS-224	M12 x 30
			QS-277	Q VMU-A M12x175 A4	OUTDOOR	466	+ QS-216	Für M12	INDOOR	475
			QS-207	Q VMZ-IG 90 M12 A4	OUTDOOR	467	QS-219	M12 x 35	OUTDOOR	475
			+ QS-219	M12 x 35	OUTDOOR	475	+ QS-215	Für M12	OUTDOOR	475
			+ QS-215	Für M12	OUTDOOR	475	QS-225	M12 x 45	OUTDOOR	475
							+ QS-215	Für M12	OUTDOOR	475

## EASY GLASS® UP





Montage	t (mm)	Anker	QS	Typ	Verwendung	Schraube / Bolzen	QS	Typ	Verwendung	
 <b>MOD 6610</b>	5,5	Chemisch	FÜR BETON					FÜR STAHL		
			QS-558	Q VMZ-IG 90 M12	INDOOR			467	QS-221	M12 x 30
			QS-557	Q VMZ-IG 90 M12 A4	OUTDOOR	467	+ QS-217	Für M12	OUTDOOR	475
		Mechanisch	QS-560	Q SZ 12/10 A4	OUTDOOR	469				
			QS-561	Q SZ-S 12/10	INDOOR	469				
 <b>MOD 6620</b>	4,5	Chemisch	FÜR BETON					FÜR STAHL		
			QS-558	Q VMZ-IG 90 M12	INDOOR			467	QS-221	M12 x 30
			QS-557	Q VMZ-IG 90 M12 A4	OUTDOOR	467	+ QS-217	Für M12	OUTDOOR	475
		Mechanisch	QS-560	Q SZ 12/10 A4	OUTDOOR	469				
			QS-561	Q SZ-S 12/10	INDOOR	469				

## EASY GLASS® BODENGLASKLEMMEN





Montage	t (mm)	Anker	QS	Typ	Verwendung	Schraube / Bolzen	QS	Typ	Verwendung	
 <b>MOD 6000</b>	12	Chemisch	FÜR BETON					FÜR STAHL		
			QS-276	Q VMU-A M12x175	INDOOR			466	QS-551	M12 x 40
			QS-277	Q VMU-A M12x175 A4	OUTDOOR	466	+ QS-217	Für M12	INDOOR	475
			QS-507	Q VMU-A M12x175	INDOOR	466	QS-221	M12 x 30	OUTDOOR	475
			QS-60	Q VMU-A M12x175 A4	OUTDOOR	466	+ QS-217	Für M12	OUTDOOR	475
 <b>MOD 6400</b>	11,5	Chemisch	FÜR BETON					FÜR STAHL		
			QS-507	Q VMU-A M12x175	INDOOR			466	QS-551	M12 x 40
			QS-60	Q VMU-A M12x175 A4	OUTDOOR	466	+ QS-217	Für M12	INDOOR	475
			QS-276	Q VMU-A M12x175	INDOOR	466	QS-221	M12 x 30	OUTDOOR	475
			QS-277	Q VMU-A M12x175 A4	OUTDOOR	466	+ QS-217	Für M12	OUTDOOR	475
			QS-559	Q VMZ-IG 105 M12 A4	OUTDOOR	467	QS-225	M12 x 45	OUTDOOR	475
							+ QS-215	Für M12	OUTDOOR	475
 <b>MOD 6100 / 6200</b>	8 / 8	Chemisch	FÜR BETON					FÜR HOLZ		
			QS-207	Q VMZ-IG 90 M12 A4	OUTDOOR			467	QS-250	10 x 80
			+ QS-74	M12 x 40	OUTDOOR	474	QS-251	10 x 120	INDOOR	471
		Mechanisch	QS-36	Q SZ-SK 12/50	INDOOR	469				
			QS-519	Q SZ-SK 12/50 A4	OUTDOOR	469				









## EASY GLASS® FRANZÖSISCHE BALKONE - EASY GLASS® VIEW

Montage	t (mm)	Anker	QS	Typ	Verwendung	Schraube / Bolzen	QS	Typ	Verwendung			
 <b>MOD 6839 / 6830</b> <b>MOD 6849</b>	4,5	 Chemisch	FÜR BETON		OUTDOOR		FÜR STAHL					
			QS-529	Q VMZ-IG 75 M8			467	QS-27	M8 x 20	OUTDOOR	474	
			+ QS-27	M8 x 20			474	QS-30	M8 x 35	OUTDOOR	474	
									FÜR HOLZ			
				 Andere	QS-266	5,5 x 50	471		QS-264	6 x 80	OUTDOOR	471
					QS-579	M16 x 65	471					

## EASY GLASS® FRANZÖSISCHE BALKONE - MOD 6507-6508













Montage	t (mm)	Anker	QS	Typ	Verwendung	Schraube / Bolzen	QS	Typ	Verwendung	
 <b>MOD 6507 / 6508</b>	4	 Chemisch	FÜR BETON		OUTDOOR		FÜR STAHL			
			QS-64	Q VMZ-A 60 M10-10/85 A4			466	QS-72	M10 x 45	OUTDOOR
				QS-273	Q VMU-A M10x130 A4	466				
				 Mechanisch	QS-58	Q BZ 10 10-30/90 A4	469			

## EASY GLASS® FRANZÖSISCHE BALKONE MIT GLASADAPTERN







Montage	t (mm)	Anker	QS	Typ	Verwendung	Schraube / Bolzen	QS	Typ	Verwendung		
 <b>MOD 0749</b>	5,5	 Chemisch	FÜR BETON		OUTDOOR		FÜR STAHL				
			QS-520	Q VMZ-IG 80 M10 A4			467	QS-533	M10 x 30	OUTDOOR	474
			+ QS-533	M10 x 30mm			474	QS-530	M10 x 35	OUTDOOR	474
 <b>MOD 0763</b>	9	 Chemisch	FÜR BETON		OUTDOOR		FÜR STAHL				
			QS-277	Q VMU-A M12x175 A4			466	QS-221	M12 x 30	OUTDOOR	475
				QS-60	Q VMU-A M12x175 A4	466	+ QS-217	Für M12	OUTDOOR	475	
				 Mechanisch	QS-560	Q SZ 12/10 A4	469				
					QS-34*	Q BZ 8 10-21/75 A4	469				

\*Optional



## ABSTURZSTANGEN

Montage	t (mm)	Anker	QS	Typ	Verwendung	Schraube / Bolzen	QS	Typ	Verwendung		
 <b>MOD 4828</b>	7	 Chemisch	FÜR BETON		OUTDOOR		FÜR STAHL				
			QS-529	Q VMZ-IG 75 M8			467	QS-20	M8 x 25	OUTDOOR	474
 <b>MOD 0842</b> <b>MOD 0843</b>	14,5	 Chemisch	FÜR BETON		OUTDOOR		FÜR STAHL				
			QS-529	Q VMZ-IG 75 M8			467	QS-22	M8 x 40	OUTDOOR	474
 <b>MOD 6517</b>	4	 Chemisch	FÜR BETON		OUTDOOR		FÜR STAHL				
			QS-529	Q VMZ-IG 75 M8			467	QS-27	M8 x 20	OUTDOOR	474
 <b>MOD 6518</b>	4	 Chemisch	FÜR BETON		OUTDOOR		FÜR STAHL				
			QS-529	Q VMZ-IG 75 M8			467	QS-27	M8 x 20	OUTDOOR	474



## EASY ALU

Montage	t (mm)	Anker	QS	Typ	Verwendung	Schraube/ Bolzen	QS	Typ	Verwendung	
<b>Boden</b>  <b>MOD 9026</b>	26	Chemisch	FÜR BETON					FÜR HOLZ		
			QS-284	Q VMU-A M12 x 265	INDOOR			466	QS-255	8 x 80
			QS-285	Q VMU-A M12 x 265	OUTDOOR	466				
<b>Seiten</b>  <b>MOD 9028-120-00</b>  <b>MOD 9028-120-90</b>	8	Chemisch	FÜR BETON					FÜR HOLZ		
			QS-276	Q VMU-A M12x175	INDOOR			466	QS-255	8 x 80
				QS-277	Q VMU-A M12x175 A4	OUTDOOR	466			
	20	Mechanisch		QS-574	Q BSZ SU 10x100	INDOOR	470			
				QS-575	Q BSZ SU 10x100 A4	OUTDOOR	470			
				QS-576	Q BSZ SU 10x120	INDOOR	470			
QS-577				Q BSZ SU 10x120 A4	OUTDOOR	470				

## SQUARE LINE® 40x40















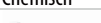

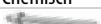

Für	t (mm)	Anker	QS	Typ	Verwendung	
<b>Boden</b>  <b>MOD 4921 / 4972</b>  <b>MOD 4942 / 4940</b>	8	Chemisch	FÜR BETON			
			QS-65	Q VMZ-A 60 M10-10/85	INDOOR	466
			QS-64	Q VMZ-A 60 M10-10/85 A4	OUTDOOR	466
		Mechanisch	QS-59	Q BZ 10 10-30/90	INDOOR	469
			QS-58	Q BZ 10 10-30/90 A4	OUTDOOR	469

## SQUARE LINE® 60x30

Für	t (mm)	Anker	QS	Typ	Verwendung	
<b>Boden</b>  <b>MOD 4901 / 3503</b>	11	Chemisch	FÜR BETON			
			QS-559	Q VMZ-IG 105 M12 A4	OUTDOOR	467
		Mechanisch	QS-577	Q BSZ SU 10x120 A4	OUTDOOR	470
<b>Seiten</b>  <b>MOD 4558</b>	11	Chemisch	FÜR BETON			
			QS-63	Q VMZ-A 50 M8-15/80	INDOOR	466
			QS-62	Q VMZ-A 50 M8-15/80 A4	OUTDOOR	466



Q-LINE

Montage	t (mm)	Anker	QS	Typ	Verwendung	Schraube / Bolzen	QS	Typ	Verwendung		
 <b>MOD 3504</b>	10	Chemisch	<b>FÜR BETON</b>		OUTDOOR						
			QS-273	Q VMU-A M10 x 130						466	
		Mechanisch									
			QS-58	Q BZ 10 10-30/90	OUTDOOR				469		
			QS-578	Q BSZ SU 8 x 70 A4	OUTDOOR				470		
 <b>MOD 0948</b> <b>MOD 0949</b>	12		<b>FÜR STAHL</b>		OUTDOOR						
			QS-223	M12 x 30						475	
			+ QS-217	Für M12	OUTDOOR				475		
			QS-219	M12 x 35	OUTDOOR				475		
			+ QS-217	Für M12	OUTDOOR				475		
			QS-225	M12 x 40	OUTDOOR				475		
			+ QS-217	Für M12	OUTDOOR				475		
 <b>MOD 0921 / 9921</b>	8	Chemisch	<b>FÜR BETON</b>		INDOOR						
			QS-65	Q VMZ-A 60 M10-10/85						466	
			QS-64	Q VMZ-A 60 M10-10/85 A4						466	
		Mechanisch									
			QS-59	Q BZ 10 10-30/90	INDOOR				469		
			QS-58	Q BZ 10 10-30/90 A4	OUTDOOR				469		
 <b>MOD 0962 / 0940</b>											
 <b>MOD 0912 / 3502</b>	8	Chemisch	<b>FÜR BETON</b>		INDOOR						
			QS-63	VMZ-A 50 M8-15/80						466	
			QS-62	Q VMZ-A 50 M8-15/80 A4						466	
		Mechanisch									
			QS-35	Q BZ 8 10-21/75	INDOOR				469		
			QS-34	Q BZ 8 10-21/75 A4	OUTDOOR				469		
 <b>MOD 0916 / 0917 / 3505</b>	13,5	Chemisch	<b>FÜR BETON</b>		INDOOR						
			QS-272	Q VMU-A M10 x 130						466	
			QS-273	Q VMU-A M10 x 130	OUTDOOR				466		
 <b>MOD 3508</b>	10	Chemisch	<b>FÜR BETON</b>		OUTDOOR						
			QS-275	Q VMU-A M12 x 155						466	
		Mechanisch									
			QS-560	Q SZ 12/10 A4						OUTDOOR	469
			QS-562	Q SZ 12/30 A4	OUTDOOR				469		
 <b>MOD 0557</b>	11	Chemisch	<b>FÜR BETON</b>		INDOOR						
			QS-33	Q VMZ-A 75 M12-25/120						466	
			QS-32	Q VMZ-A 75 M12-25/120 A4	OUTDOOR				466		
 <b>MOD 0555</b> <b>0551 / 0552</b>											
 <b>MOD 0558</b>	10,5	Chemisch	<b>FÜR BETON</b>		INDOOR						
			QS-33	Q VMZ-A 75 M12-25/120						466	
			QS-275	Q VMU-A M12x155						OUTDOOR	466
 <b>MOD 0556</b>	20	Chemisch	<b>FÜR BETON</b>		INDOOR						
			QS-505	Q VMZ-IG 105 M12						467	
			+ QS-551	M12 x 40						INDOOR	474
			+ QS-217	Für M12						INDOOR	475
			<b>FÜR STAHL</b>		INDOOR						
		QS-551	M12 x 40	474							



**MOD 4410**

Stahl, verzinkt

INDOOR	QS	Typ	d		L	
254410-811	QS-270	QVMU-A M8x110	M8	Ø 10	110	10
254410-820	QS-281	QVMU-A M8x205	M8	Ø 10	205	10
254410-113	QS-272	QVMU-A M10x130	M10	Ø 12	130	10
254410-215	QS-274	QVMU-A M12x155	M12	Ø 14	155	10
254410-217	QS-276	QVMU-A M12x175	M12	Ø 14	175	10
254410-226	QS-284	QVMU-A M12x265	M12	Ø 14	265	10

**V4A 316**

OUTDOOR

244410-811	QS-271	QVMU-A M8x110	M8	Ø 10	110	10
244410-820	QS-282	QVMU-A M8x205	M8	Ø 10	205	10
244410-113	QS-273	QVMU-A M10x130	M10	Ø 12	130	10
244410-215	QS-275	QVMU-A M12x155	M12	Ø 14	155	10
244410-217	QS-277	QVMU-A M12x175	M12	Ø 14	175	10
244410-226	QS-285	QVMU-A M12x265	M12	Ø 14	265	10



**Q-INFO** MOD 4410

Montage-Informationen Q-Anker VMU-A

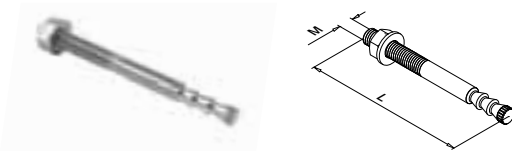
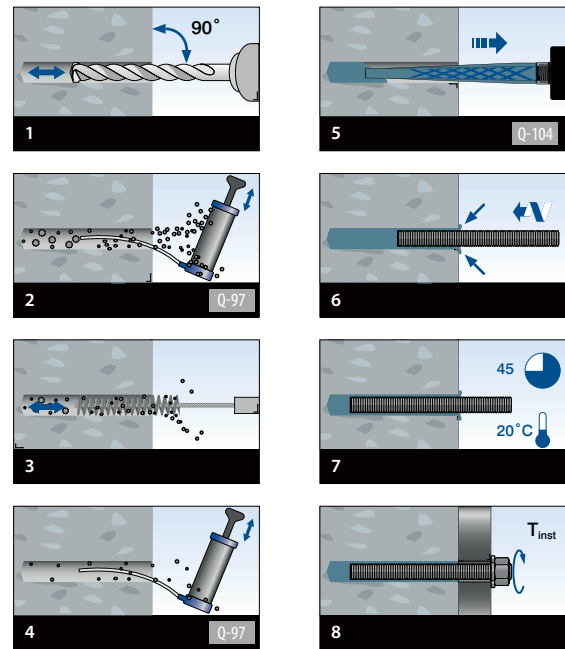

**MOD 4010**

Stahl, verzinkt

INDOOR	QS	Typ		L	
254010-880	QS-63	QVMZ-A 50 M8-15/80	Ø 10	80	10
254010-185	QS-65	QVMZ-A 60 M10-10/85	Ø 12	85	10
254010-212	QS-33	QVMZ-A 75 M12-25/120	Ø 14	120	10
254010-217	QS-507	QVMZ-A 125 M12-25/170	Ø 14	170	10

**V4A 316**

OUTDOOR

244010-880	QS-62	QVMZ-A 50 M8-15/80 A4	Ø 10	80	10
244010-185	QS-64	QVMZ-A 60 M10-10/85 A4	Ø 12	85	10
244010-212	QS-32	QVMZ-A 75 M12-25/120 A4	Ø 14	120	10
244010-213	QS-549	QVMZ-A75 M12-40/135 A4	Ø 14	135	10
244010-217	QS-60	QVMZ-A 125 M12-25/170 A4	Ø 14	170	10



**Q-INFO** MOD 4010

Montage-Informationen Q-Anker VMZ-A

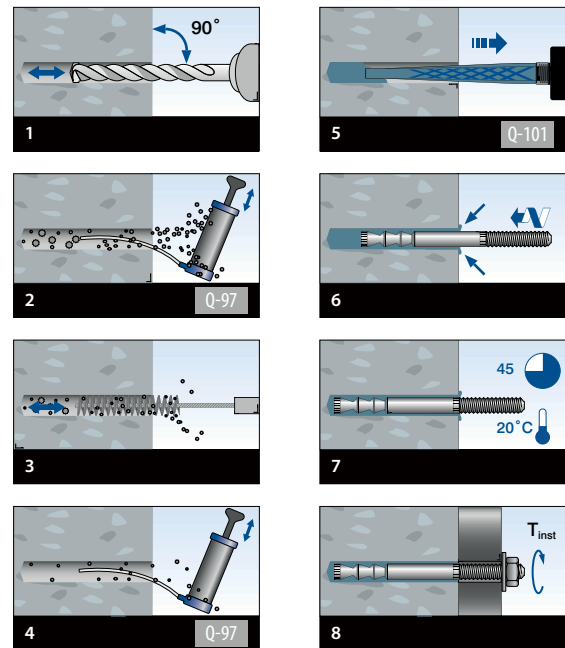

Chemische Betonanker



MOD 4510

Stahl, verzinkt

INDOOR	QS	Typ	d		L	
254510-875	QS-528	QVMZ-IG 75 M8	M8	Ø 12	78	10
254510-180	QS-521	QVMZ-IG 80 M10	M10	Ø 14	84	10
254510-290	QS-208	QVMZ-IG 90 M12	M12	Ø 18	94	10
254510-210	QS-505	QVMZ-IG 105 M12	M12	Ø 18	109	10
254510-212	QS-212	QVMZ-IG 125 M12	M12	Ø 18	130	10

V4A 316

OUTDOOR

244510-875	QS-529	QVMZ-IG 75 M8	M8	Ø 12	78	10
244510-180	QS-520	QVMZ-IG 80 M10 A4	M10	Ø 14	84	10
244510-290	QS-207	QVMZ-IG 90 M12 A4	M12	Ø 18	94	10
244510-212	QS-211	QVMZ-IG 125 M12 A4	M12	Ø 18	130	10

Q-INFO MOD 4510

Montage-Informationen Q-Anker VMZ-IG

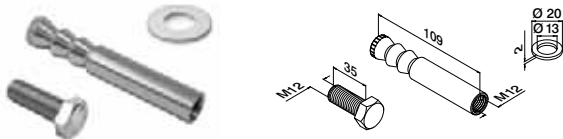
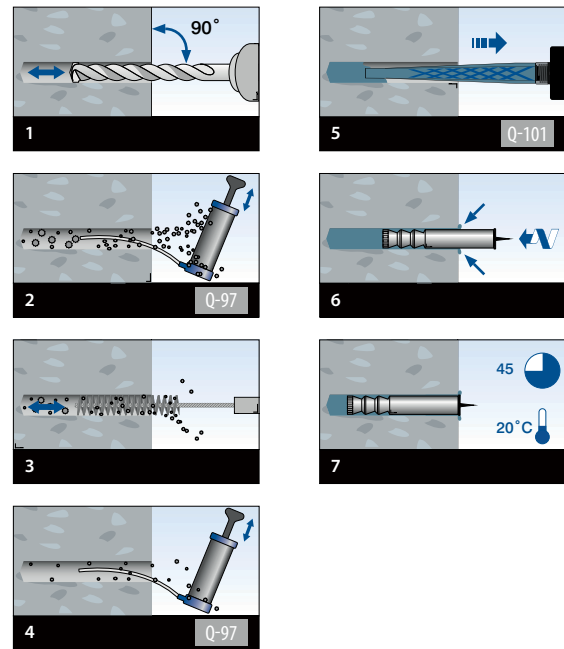

MOD 4519

V4A 316

OUTDOOR

244519-210	QS-559	QVMZ-IG 105 M12 A4	Ø 18	10
------------	--------	--------------------	------	----

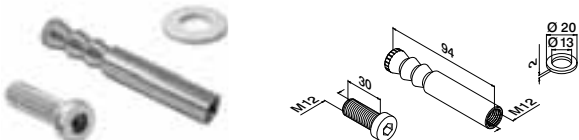

MOD 4519

Stahl, verzinkt

INDOOR	QS	Typ		
254519-290	QS-558	QVMZ-IG 90 M12	Ø 18	10

V4A 316

OUTDOOR

244519-290	QS-557	QVMZ-IG 90 M12 A4	Ø 18	10
------------	--------	-------------------	------	----



Q-INFO MOD 4519

Montage-Informationen Q-Anker VMZ-IG

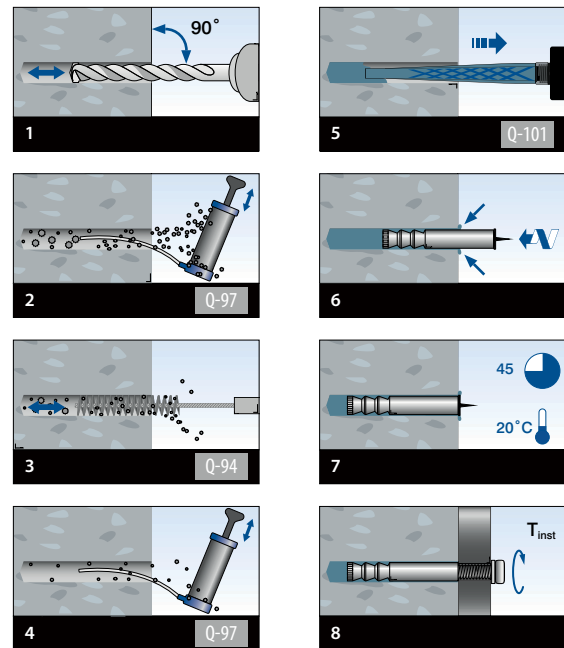

Zubehör für chemische Betonanker



Injektionsmörtel

**MOD 4089 / 4090**

Zubehör				
	Q	e		
204089-28	Q-104	280 ml	Q-VMU-A	1
<b>NEW</b> 204089-30	Q-104	300 ml	Q-VMU-A	1
204090-28	Q-101	280 ml	Q-VMZ	1
<b>NEW</b> 204090-30	Q-101	300 ml	Q-VMZ	1



Statikmischer für Injektionsmörtel

**MOD 4091**

Zubehör		
	Q	
204091	Q-103	1



Verlängerung für Statikmischer für Injektionsmörtel VMZ 280/300, 200 mm

**MOD 4096**

Zubehör		
	Q	
204096	Q-88	1



Auspresspistole für Injektionsmörtel

**MOD 4095**

Zubehör		
	Q	
204095	Q-102	1



Ausbläser für Bohrlöcher

**MOD 4092**

Zubehör		
	Q	
204092	Q-97	1



Reinigungsbürste für Bohrlöcher

**MOD 4093**

Zubehör			
	Q		
204093-010	Q-91	Ø 10	1
204093-012	Q-92	Ø 12	1
204093-014	Q-93	Ø 14	1
204093-018	Q-94	Ø 18	1
204093-020	Q-95	Ø 20	1



Verlängerung für Reinigungsbürste mit M6 Anschlussgewinde, 150 mm

**MOD 4094**

Zubehör		
	Q	
204094	Q-89	1

**Q-INFO** | MOD 4089 / 4090

Anzahl Bohrlochfüllungen pro Injektionskartusche

VMZ-A	QS-32	QS-33	QS-60	QS-62	QS-63	QS-64	QS-65	QS-507	QS-549	Q-101 / Q-104 280 ml 204090-28 204089-28
Q-101 (280 ml)	34	34	24	58	58	39	39	24	34	
Q-101 (300 ml)	36	36	25	62	62	41	41	25	36	

VMZ-IG	QS-207	QS-208	QS-211	QS-212	QS-505	QS-520	QS-521	QS-528	QS-557	QS-558	QS-559	Q-101 / Q-104 300 ml 204090-30 204089-30
Q-101 (280 ml)	21	21	16	16	19	27	27	34	21	21	19	
Q-101 (300 ml)	22	22	17	17	20	29	29	36	22	22	20	

VMU-A	QS-270	QS-271	QS-281	QS-282	QS-272	QS-273	QS-274	QS-275	QS-276	QS-277	QS-284	QS-285
Q-104 (280 ml)	46	46	40	40	32	32	22	22	22	22	19	19
Q-104 (300 ml)	50	50	42	42	34	34	23	23	23	23	20	20



## Mechanische Betonanker



## MOD 4110

Stahl, verzinkt

INDOOR	QS	Typ	d	Ø	L	Ø
254110-875	QS-35	Q BZ 8 10-21/75	M8	Ø 8	75	10
254110-190	QS-59	Q BZ 10 10-30/90	M10	Ø 10	90	10

V4A 316

OUTDOOR

244110-875	QS-34	Q BZ 8 10-21/75 A4	M8	Ø 8	75	10
244110-190	QS-58	Q BZ 10 10-30/90 A4	M10	Ø 10	90	10



## MOD 4210

Stahl, verzinkt

INDOOR	QS	Typ	Ø	Ø	L	Ø
254210-212	QS-36	Q SZ-SK 12/50	12	Ø 12	120	25

V4A 316

OUTDOOR

244210-212	QS-519	Q SZ-SK 12/50 A4	12	Ø 12	120	25
------------	--------	------------------	----	------	-----	----



## MOD 4220

Stahl, verzinkt

INDOOR	QS	Typ	Ø	Ø	L	Ø
254220-285	QS-561	Q SZ-S 12/10	12	Ø 12	85	25
254220-211	QS-563	Q SZ-S 12/30	12	Ø 12	105	25

V4A 316

OUTDOOR

244220-285	QS-560	Q SZ-S 12/10 A4	12	Ø 12	85	25
244220-211	QS-562	Q SZ-S 12/30 A4	12	Ø 12	105	25



## Q-INFO MOD 4110

Montage-Informationen Q-Anker BZ Plus 8 &amp; BZ Plus 10

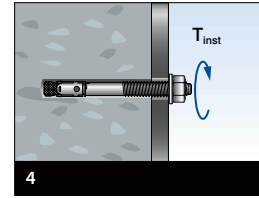
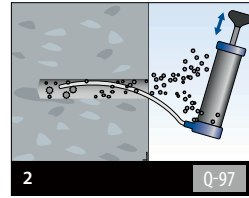
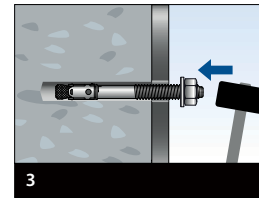
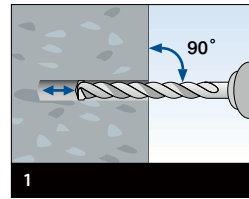

## Q-INFO MOD 4210

Montage-Informationen Q-Anker SZ-SK 12/50

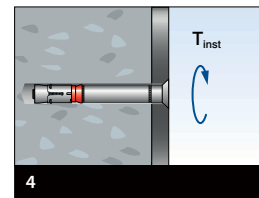
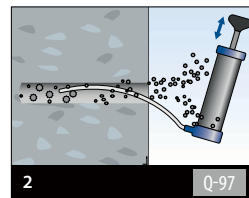
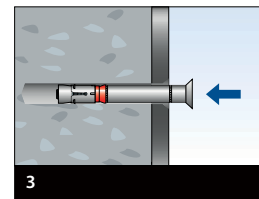
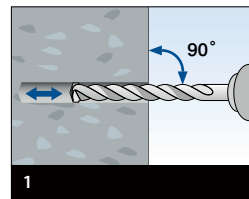

## Q-INFO MOD 4220

Montage-Informationen Q-Anker SZ-S 12/10-30

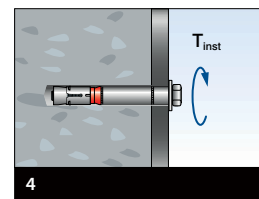
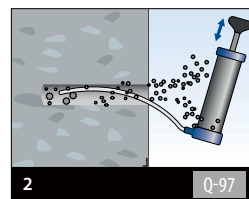
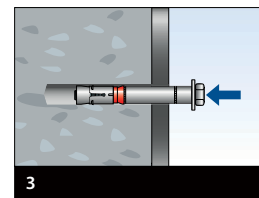
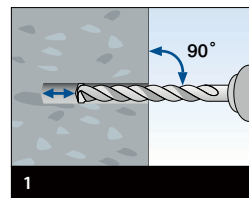



Betonschrauben



MOD 4310

Stahl, verzinkt

INDOOR	QS	Typ	Ø	L	50	
254310-110	QS-574	Q BSZ SU 10x100	10	Ø 10	100	50
254310-112	QS-576	Q BSZ SU 10x120	10	Ø 10	120	50

V4A 316

OUTDOOR

244310-110	QS-575	Q BSZ SU 10x100 A4	10	Ø 10	100	50
244310-112	QS-577	Q BSZ SU 10x120 A4	10	Ø 10	120	50
NEW 244310-870	QS-578	Q-BSZ SU 8x70 A4	8	Ø 8	70	50



MOD 4300

Stahl, verzinkt

INDOOR	QS	Typ	Q	Ø	L	50	
254300-110	QS-571	Q BSZ SK 10x100	114	10	Ø 10	100	50

V4A 316

OUTDOOR

244300-110	QS-572	Q BSZ SK 10x100 A4	114	10	Ø 10	100	50
244300-112	QS-573	Q BSZ SK 10x120 A4	114	10	Ø 10	120	50



MOD 0665

V4A 316

OUTDOOR

QS	Für d	50	
240665-232	QS-286	M12	25

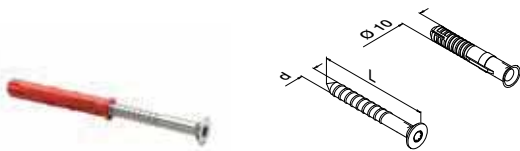

MOD 4250

V4A 316

OUTDOOR

SELL OUT	QS	d	Ø	L	50
244250-180	QS-214	7	Ø 10	80	50



Q-INFO MOD 4310

Montage-Informationen Q-Anker Q BSZ SU 10x100 + 10x120 (A4)

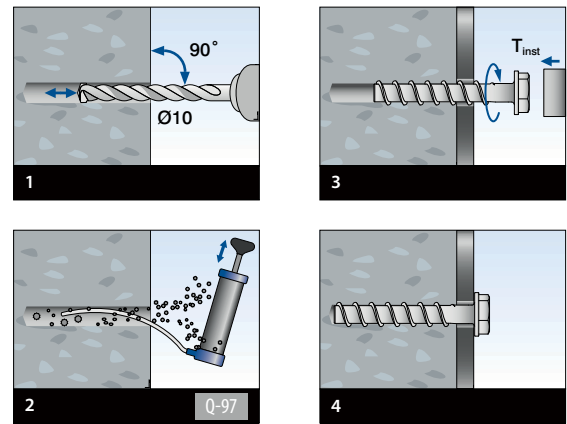

Q-INFO MOD 4300

Montage-Informationen Q-Anker Q BSZ SK 10x100 + 10x120 (A4)

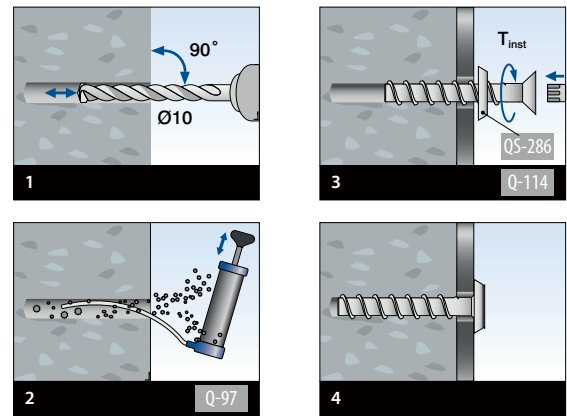

MOD 4260

V4A 316

OUTDOOR

SELL OUT	QS	d	Ø	L	50
244260-180	QS-213	7	Ø 10	80	50



Schrauben

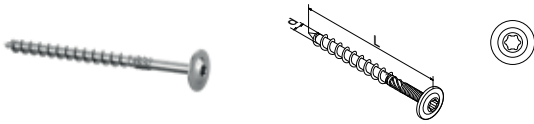

MOD 0250

Stahl, verzinkt

INDOOR	QS	Q	d	L	☐
250250-808	QS-255	Q-113	8	80	50
250250-812	QS-256	Q-113	8	120	50
250250-012	QS-258	Q-114	10	120	50

V2A 304

INDOOR

230250-608	QS-264	Q-115	6	80	50
230250-610	QS-265	Q-115	6	100	50



Q-INFO MOD 0250

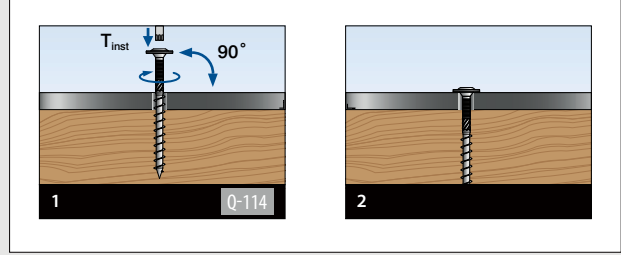

MOD 0805

V4A 316

OUTDOOR

OUTDOOR	QS	Q	d	Ø	L	☐
230805-665	QS-579	Q-8	M8	M16	65	2

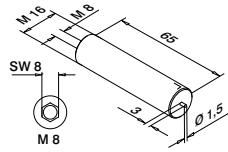

Q-INFO MOD 0805

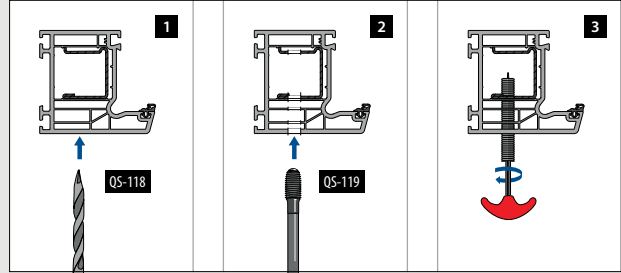

MOD 0260

Stahl, verzinkt

INDOOR	QS	Q	d	L	☐
250260-008	QS-250	Q-113	10	80	50
250260-012	QS-251	Q-113	10	120	50

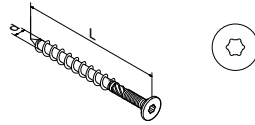

MOD 0915

V4A 316

OUTDOOR

OUTDOOR	QS	☐
240915-550	QS-266	50



MOD 0251

Stahl, verzinkt C4

OUTDOOR	QS	d	L	☐
250251-010	QS-290	10	100	25



MOD 1016

Zubehör

Zubehör	Q	Ø	AW	L	☐
201016-230	Q-115	1/4"	30	25	1
201016-240	Q-113	1/4"	40	26	1
201016-550	Q-114	5/16"	50	50	1



Bit 1/4", 5/16" Antrieb

Q-INFO MOD 0915

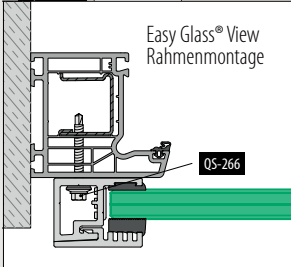

Q-INFO MOD 0805

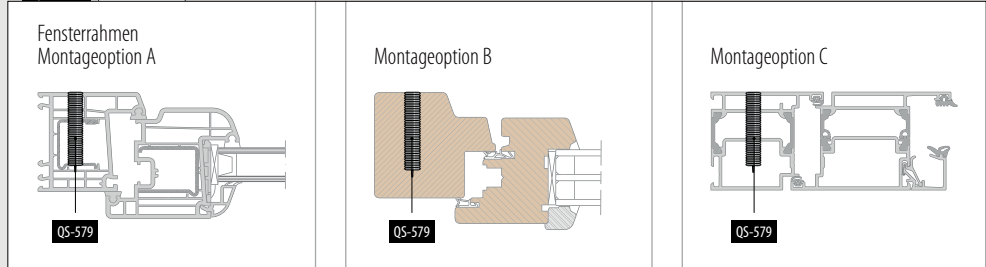

Dübel



MOD 0841

Zubehör		QS	Ø	L	
200841-635	QS-87	6	35	100	
200841-160	QS-555	10	60	50	

SELL OUT



MOD 0843

Stahl, verzinkt		QS	Für	
IN/OUTDOOR				
200843-008	QS-570	M8	25	



MOD 0491 - DIN 914 / ISO 4027

V2A	304	QS	Q	d	L	
INDOOR						
230491-850	QS-288	4	M8	50	50	



MOD 0851

Messing		QS	
IN/OUTDOOR			
200851-827	QS-55	50	

Q-INFO | MOD 0841

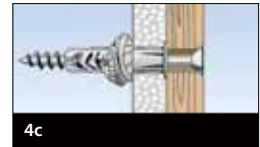

Q-INFO | MOD 0843 / 0491

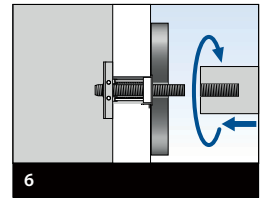
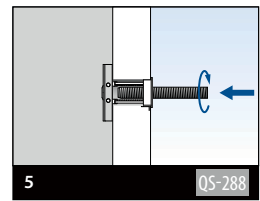
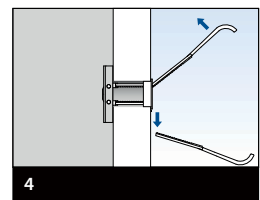
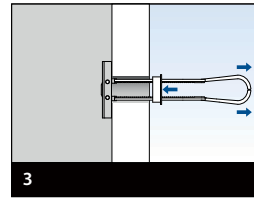
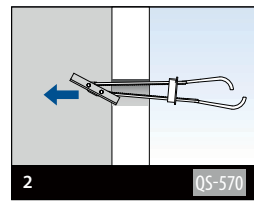
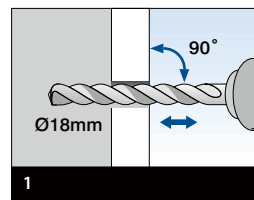

Q-INFO | MOD 0851

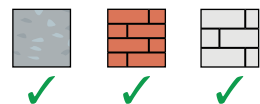
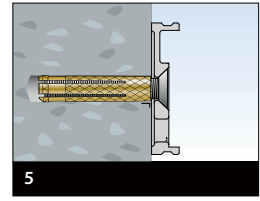
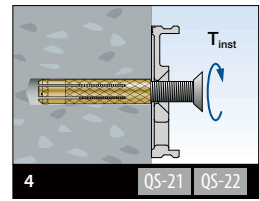
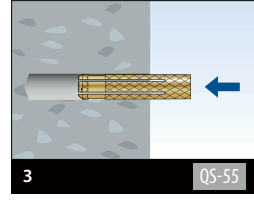
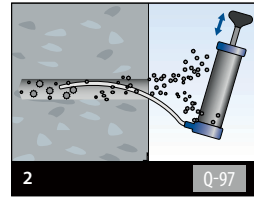
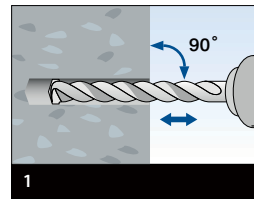

## Schrauben

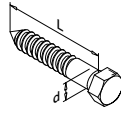

## MOD 0200 - DIN 571

V2A	304				
INDOOR		QS	d	L	
230200-760	QS-3	7	60	50	

V4A	316				
OUTDOOR					
240200-760	QS-4	7	60	50	
240200-890	QS-556	8	90	50	

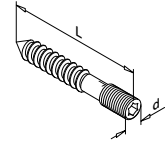

## MOD 0205

V2A	304					
INDOOR		QS	Q	d	L	
230205-050	QS-1	Q-4	M8 x 12	50	50	
230205-090	QS-85	Q-4	M8 x 33	90	50	

V4A	316					
OUTDOOR						
240205-050	QS-2	Q-4	M8 x 12	50	50	
240205-090	QS-86	Q-4	M8 x 33	90	50	

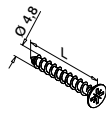

## MOD 0210 - DIN 7982 C-H

V2A	304			
INDOOR		QS	L	
230210-025	QS-5	25	50	
230210-038	QS-7	38	50	
230210-060	QS-503	60	50	

  

V4A	316			
OUTDOOR				
240210-025	QS-6	25	50	
240210-038	QS-50	38	50	
240210-060	QS-504	60	50	

SELL  
OUT

## MOD 0240

V2A	304			
INDOOR		QS	L	
230240-412	QS-200	12	50	

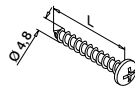

## MOD 0230 - DIN 7981 C-H

V2A	304			
INDOOR		QS	L	
230230-025	QS-8	25	50	
230230-038	QS-56	38	50	

  

V4A	316			
OUTDOOR				
240230-025	QS-9	25	50	
240230-038	QS-57	38	50	

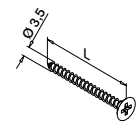

## MOD 0211 - DIN 7997

V2A	304			
INDOOR		QS	L	
230211-340	QS-49	40	50	

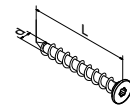

## MOD 0212 - ISO 14586

V4A	316				
OUTDOOR		QS	d	L	
240212-413	QS-268	4,2	13	50	
240212-438	QS-267	4,2	38	50	



## Schrauben

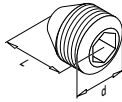

## MOD 0400 - DIN 916 / ISO 4029

V2A	304					
INDOOR		QS	Q	d	L	☐
230400-505	QS-91	Q-2,5	M5	5	50	

V4A	316					
OUTDOOR						
240400-505	QS-90	Q-2,5	M5	5	50	
240400-610	QS-92	Q-3	M6	10	50	

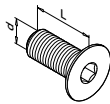

## MOD 0670 - DIN 7991

V2A	304					
INDOOR		QS	Q	d	L	☐
230670-520	QS-12	Q-3	M5	20	50	
230670-612	QS-48	Q-4	M6	12	50	
230670-620	QS-14	Q-4	M6	20	50	
230670-625	QS-15	Q-4	M6	25	50	
230670-630	QS-17	Q-4	M6	30	50	
230670-825	QS-19	Q-5	M8	25	50	
230670-840	QS-21	Q-5	M8	40	50	
230670-130	QS-532	Q-6	M10	30	50	
230670-135	QS-531	Q-6	M10	35	50	

V4A	316					
OUTDOOR						
240670-520	QS-13	Q-3	M5	20	50	
240670-608	QS-205	Q-4	M6	8	50	
240670-612	QS-89	Q-4	M6	12	50	
240670-625	QS-16	Q-4	M6	25	50	
240670-630	QS-18	Q-4	M6	30	50	
240670-825	QS-20	Q-5	M8	25	50	
240670-840	QS-22	Q-5	M8	40	50	
240670-130	QS-533	Q-6	M10	30	50	
240670-135	QS-530	Q-6	M10	35	50	
240670-240	QS-74	Q-8	M12	40	50	

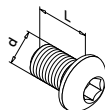

## MOD 0690 - ISO 7380

V2A	304					
INDOOR		QS	Q	d	L	☐
230690-510	QS-202	Q-3	M5	10	50	
230690-516	QS-10	Q-3	M5	16	50	
230690-616	QS-83	Q-4	M6	16	50	

V4A	316					
OUTDOOR						
240690-510	QS-203	Q-3	M5	10	50	
240690-516	QS-11	Q-3	M5	16	50	
240690-608	QS-261	Q-4	M6	8	50	
240690-616	QS-84	Q-4	M6	16	50	

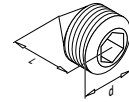

## MOD 0490 - DIN 914 / ISO 4027

V2A	304					
INDOOR		QS	Q	d	L	☐
230490-506	QS-94	Q-2,5	M5	6	50	

V4A	316					
OUTDOOR						
240490-506	QS-93	Q-2,5	M5	6	50	

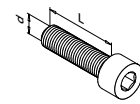

## MOD 0680 - DIN 912 / ISO 4762

## Stahl, verzinkt

INDOOR		QS	Q	d	L	☐
250680-820	QS-28	Q-6	M8	20	50	

V2A	304					
INDOOR		QS	Q	d	L	☐
230680-620	QS-23	Q-5	M6	20	50	
230680-635	QS-24	Q-5	M6	35	50	
230680-645	QS-54	Q-5	M6	45	50	
230680-660	QS-25	Q-5	M6	60	50	
230680-820	QS-26	Q-6	M8	20	50	
230680-835	QS-29	Q-6	M8	35	50	
230680-140	QS-67	Q-8	M10	40	50	
230680-240	QS-551	-	M12	40	50	

V4A	316					
OUTDOOR						
240680-620	QS-53	Q-5	M6	20	50	
240680-645	QS-70	Q-5	M6	45	50	
240680-660	QS-71	Q-5	M6	60	50	
240680-820	QS-27	Q-6	M8	20	50	
240680-835	QS-30	Q-6	M8	35	50	
240680-140	QS-72	Q-8	M10	45	50	

SELB  
OUT



## Bolzen

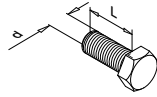

## MOD 0661 - DIN 933

Stahl, verzinkt

INDOOR	QS	d	L	
250661-230	QS-224	M12	30	50

V4A 316

OUTDOOR

240661-230	QS-223	M12	30	50
240661-235	QS-219	M12	35	50
240661-245	QS-225	M12	45	50

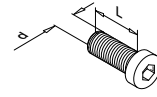

## MOD 0662 - DIN 7984

Stahl, verzinkt

INDOOR	QS	Q	d	L	
250662-230	QS-222	Q-8	M12	30	50

V4A 316

OUTDOOR

240662-230	QS-221	Q-8	M12	30	50
------------	--------	-----	-----	----	----



## Unterlegscheiben

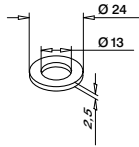

## MOD 0663 - DIN 125A / ISO 7089

Stahl, verzinkt

INDOOR	QS	Für d	
250663-224	QS-216	M12	50

V4A 316

OUTDOOR

240663-224	QS-215	M12	50
------------	--------	-----	----

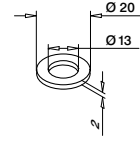

## MOD 0664 - DIN 433 / ISO 7092

V4A 316

INDOOR	QS	Für d	
240664-220	QS-217	M12	50

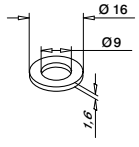

## MOD 0666 - DIN 125A / ISO 7089

V4A 316

OUTDOOR

INDOOR	QS	Für d	
240666-816	QS-287	M8	50

## (Hut-)Muttern

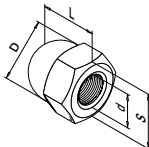

## MOD 0650 - DIN 1587

V2A 304

INDOOR	QS	S	d	D	L	
230650-865	QS-514	13	M8	12,5	15	50
230650-108	QS-517	17	M10	16	18	50
230650-210	QS-518	19	M12	18	22	50

V4A 316

OUTDOOR

240650-865	QS-513	13	M8	12,5	15	50
240650-108	QS-515	17	M10	16	18	50
240650-210	QS-516	19	M12	18	22	50

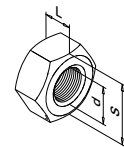

## MOD 0651 - DIN 934

V4A 316

INDOOR	QS	S	d	L	
240651-208	QS-289	19	M12	10	50

SELL  
OUT

Befestigungsmaterial für Glasklemmen

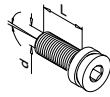

Justierbare Schraube  
+/- 5°

**MOD 0681**

Für alle Modelle in Zinkdruckguss

Stahl, verzinkt						
INDOOR	QS	Q	d	L		
250681	QS-46	Q-5	M8	20	50	

Für alle Modelle in V2A

V2A	304					
INDOOR	QS	Q	d	L		
230681	QS-47	Q-5	M8	20	50	

Für alle Modelle in V4A

V4A	316					
OUTDOOR	QS	Q	d	L		
240681	QS-45	Q-5	M8	20	50	

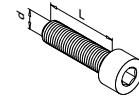

Zylinderschraube mit Innensechskant

**MOD 0680 - DIN 912 / ISO 4762**

Für alle Modelle in Zinkdruckguss

Stahl, verzinkt						
INDOOR	QS	Q	d	L		
250680-820	QS-28	Q-6	M8	20	50	

Für alle Modelle in V2A

V2A	304					
INDOOR	QS	Q	d	L		
230680-820	QS-26	Q-6	M8	20	50	

Für alle Modelle in V4A

V4A	316					
OUTDOOR	QS	Q	d	L		
240680-820	QS-27	Q-6	M8	20	50	

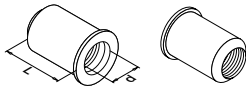

Blindnietmutter mit Flachkopf

**MOD 0800**

V2A	304						
INDOOR	QS	Q	d	Ø	L		
230800-616	QS-38	Q-29	M6	Ø 9,0	16	50	
230800-817	QS-39	Q-29	M8	Ø 11,0	17	50	
230800-121	QS-40	Q-29	M10	Ø 12,0	21	50	

V4A	316						
OUTDOOR	QS	Q	d	Ø	L		
240800-616	QS-80	Q-29	M6	Ø 9,0	16	50	
240800-817	QS-81	Q-29	M8	Ø 11,0	17	50	
240800-121	QS-82	Q-29	M10	Ø 12,0	21	50	

SELL OUT

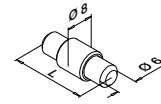

Sicherungsstifte für Glasklemmen und Blechadapter

**MOD 5015**

Zubehör	Für MOD	L	
205015-22	2800, 4200	22	4
205015-25	2500, 2600	25	4
205015-24	2400, 6000	30	4
205015-23	2300	34	4

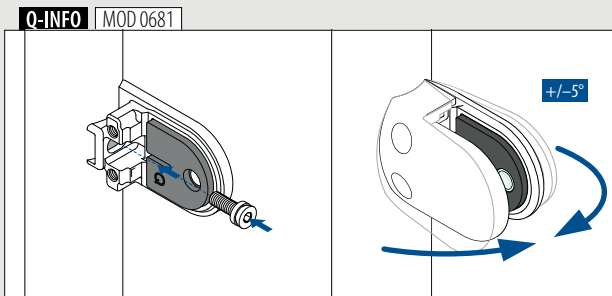
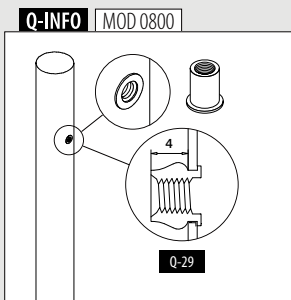

SELL OUT Nur solange der Vorrat reicht.

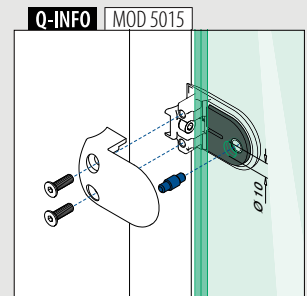
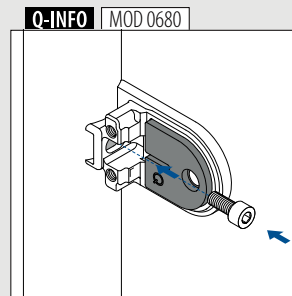

Ersatzmaterial für Glasklemmen

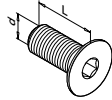

Senkkopfschraube mit Innensechskant

**MOD 0670 - DIN 7991**

Für MOD 2100, 2500, 2700, 2800, 4200, 4400, 4600 in Zinkdruckguss

Stahl, verzinkt					
INDOOR	QS	Q	d	L	
250670-616	QS-43	Q-4	M6	16	50

Für MOD 2400 in Zinkdruckguss

Stahl, verzinkt					
INDOOR	QS	Q	d	L	
250670-620	QS-44	Q-4	M6	20	50

Für MOD 2100, 2500, 2700, 2800, 4200, 4400, 4600, 5100, 5200 in V2A und V4A

V4A 316					
OUTDOOR	QS	Q	d	L	
240670-616	QS-41	Q-4	M6	16	50

Für MOD 2300, 2400, 2600 in V2A und V4A

V4A 316					
OUTDOOR	QS	Q	d	L	
240670-620	QS-42	Q-4	M6	20	50



Kunststoff-Abdeckkappen für seitliche Schrauben (2 Stück pro Glasklemme)

**MOD 5010**

Zubehör		Farbe	Für MOD	
205010-00-00		Roh (grau)		8
205010-00-17		Glanzverchromt	2100, 2300, 2400, 2500,	8
205010-00-19		Edelstahleffekt	2600, 2700,	8
205010-00-31		Schwarz RAL 9005	4200, 4400,	8
205010-00-32		Weiß RAL 9016	4600, 5100, 5200	8
205010-00-33		Anthrazitgrau RAL 7016		8
205010-28-00		Roh (grau)		8
205010-28-17		Glanzverchromt	2800	8
205010-28-19		Edelstahleffekt		8
205010-28-31		Schwarz RAL 9005		8

Einlagen für Glasadapter

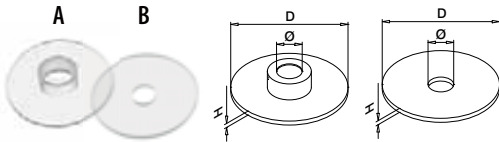

**MOD 5031 / 5032 / 5034 / 5035 / 5039 / 5038 / 5030**

Zubehör		Für MOD	D	Ø	H	Stück pro Glasadapter	
205032-47	A	0747 + 0750 + 0751 (Ø 50mm)	48	10	2	1	8
205031-47	B		48	10	2	1	8
205034-030	A	0746 + 0740 + 0754 (Ø 30 mm)	28	8	2	2	8
205034-025	A	0755 (Ø 25 mm)	24	6	1	1	8
205035	B		24	6	1	1	8
205034-050	A	0148 + 0117 + 9350 (Ø 50 mm)	48	8	2	2	8
205039	A	0752 + 0753	38	8	2	1	8
205038	B		38	8	2	1	8
<b>NEW</b> 205030-150-01-03	A	0749	45	19	3	1	8
<b>NEW</b> 205030-150-02-03	B		46	13	3	1	8

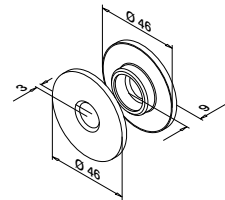

**MOD 5030**

Zubehör		Für MOD	
205030-150-99-80		0749	4

**NEW**

**Q-INFO** MOD 0670

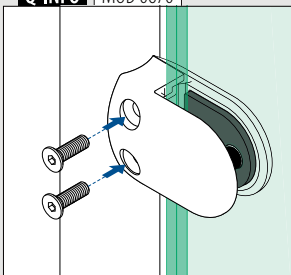

## Bohren und Gewindeschneiden



14-teiliges Bohrer- und Gewindeschneideset für Edelstahl

## MOD 1025

Zubehör			
	Q	M	
201025	Q-61	M3 - M12	1



Bohrschablone

## MOD 1020

Zubehör				
	Q	Für Rohr Ø	M	
201020-042	Q-74	42,4	M5, M6, M8, M10	1
201020-048	Q-75	48,3	M5, M6, M8, M10	1



Gewindeschneider für MOD 0805

## MOD 1029

Zubehör		
	Q	
201029	Q-119	1

NEW



Bohrer für MOD 0805

## MOD 1028

Zubehör		
	Q	
201028	Q-118	1

NEW

## Komplettes Set



Bohrschablone, 2-fach mit Führung

## MOD 1021

Zubehör				
	Q	Für Rohr Ø	M	
201021-042	Q-76	42,4	M5, M6, M8, M10	1
201021-048	Q-77	48,3	M5, M6, M8, M10	1

SELL OUT

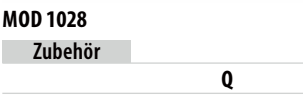

Bohrer für MOD 0805

## MOD 1028

Zubehör		
	Q	
201028	Q-118	1

NEW

Bohr- und Schneidöl  
Konzentriert, ohne Treibgas

## MOD 1027

Zubehör			
	Q	e	
201027	Q-64	300 ml	1

## Q-INFO | MOD 1021

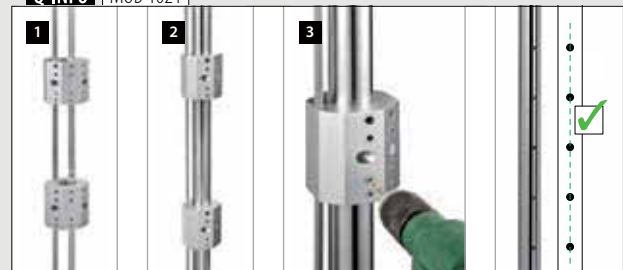

Bohren und Gewindeschneiden

Bohrschablone für Easy Alu Geländerpfosten

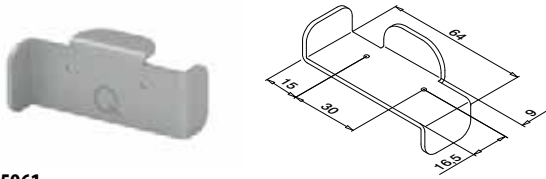

**MOD 5961**

Zubehör		
	Q	
205961	Q-85	1



Bohrschablone für Glas-Stopp

**MOD 1041**

Zubehör		
	Q	
201041	Q-117	1

NEW

Bohrschablonen für Glasleistenrohre, Set

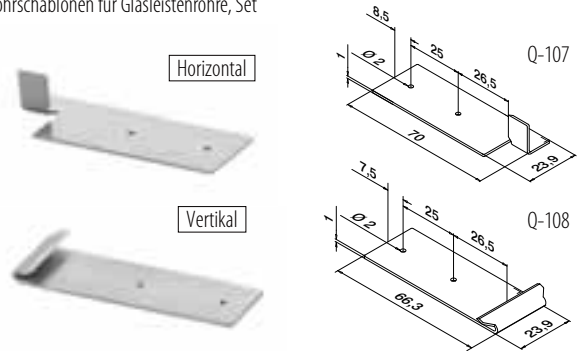

**MOD 1022**

Zubehör		
	Q	
201022	Q-107/Q-108	1

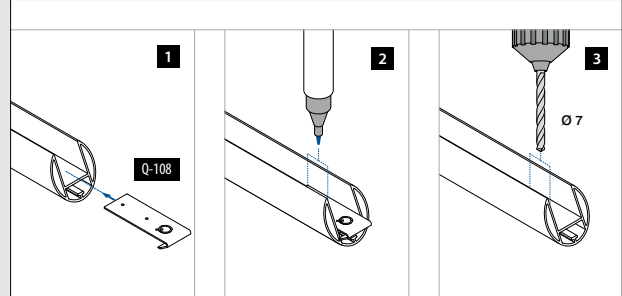
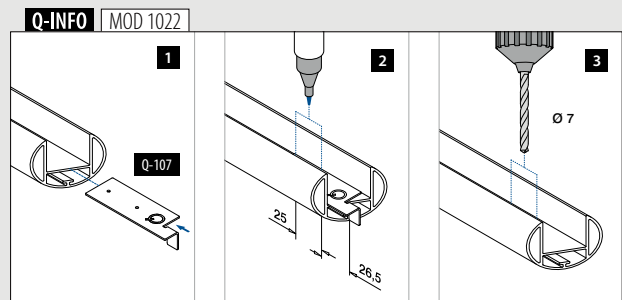
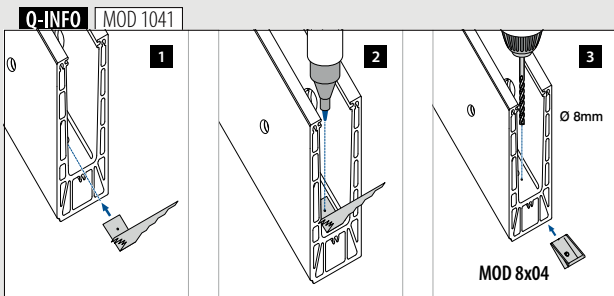
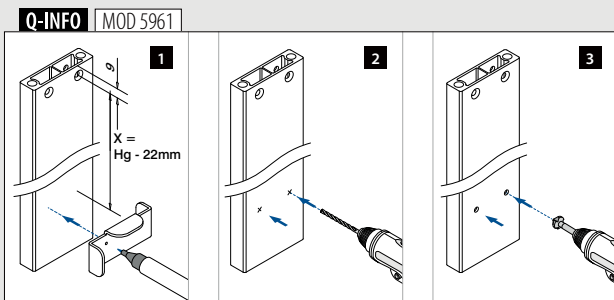



Q-82

Q-20

Bohrschablone



**MOD 1023**

Zubehör			
	Q	Für Ø	
201023	Q-82	42,0 + 48,0	1

**MOD 1024**

Zubehör			
	Q	Für Ø	
201024-042	Q-20	42,0	1



Holzleim

PVAC Leim zur Verbindung von Holzbauteilen

**MOD 1335**

Zubehör			
	Q	e	
201335	Q-73	250 ml	1

Verbindungsstifte

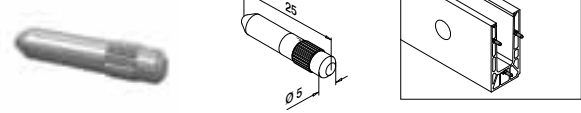

**MOD 3005**

V4A	316	Roh	
<b>OUTDOOR</b>			
143005			6



Bohrer mit Stopper für Holz



**MOD 1026**

Zubehör			
	Q	D	
201026	Q-80	15	1

Dübel



**MOD 0203**

Holz		
INDOOR		
	QS	
200203	QS-512	50



**MOD 0803 - DIN 7965**

Stahl, verzinkt						
INDOOR						
	QS	d		L		
250803-120	QS-66	M10	Ø 17	20	50	
V2A 304						
INDOOR						
230803-818	QS-69	M8	Ø 14,5	18	50	



Kabelbinder



**MOD 1050**

Zubehör			
	Q	L	
201050	Q-50	300	100

MONTAGEZUBEHÖR

ZUBEHÖR

**Q-INFO** | MOD 1024

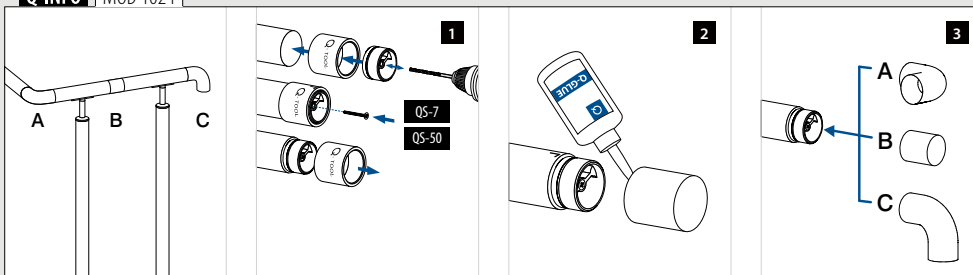

**Q-INFO** | MOD 1023 / 1024

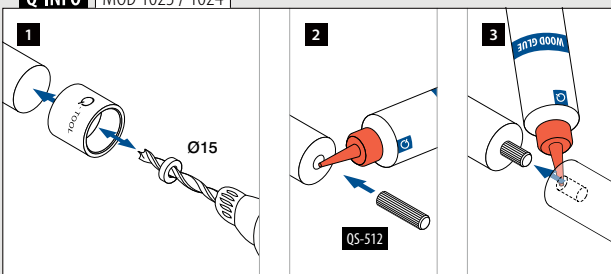

**Q-INFO** | MOD 0803

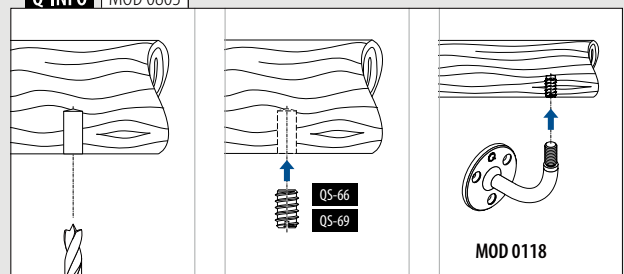

Montagezubehör



Q-glue®  
Spezialkleber für Edelstahl.  
Verbrauch pro Verbindung ca. 1 ml

MOD 1331

Zubehör			
	Q	e	
201331	Q-21	50 ml	1

Klebeverbindungen pro Flasche (50 ml)

Ø 16 mm	Ø 42,4 mm	Ø 48,3 mm	Ø 60,3 mm
150	60	50	40



Acrylat-Klebeband

MOD 1360

Zubehör				
	Q	W	L	
201360	Q-53	9	33 m (für 11 m Blendleiste)	1



Transparentes Acrylat-Klebeband

MOD 1362

Zubehör				
	Q	W	L	
201362-012	Q-122	12	33 m	1

NEW



Q-spray, transparent  
Für die reibungslose Montage

MOD 0620

Zubehör			
	Q	e	
200620	Q-65	1000 ml	1



Q-seal  
Glas-Silikon, Farbe schwarz,  
mit beigelegten Düsen

MOD 1340

Zubehör			
	Q	e	
201340	Q-24	310 ml = ca. 11,40 m	1



Doppelseitiges Klebeband, geschäumt

MOD 1361

Zubehör				
	Q	W	L	
201361-012	Q-111	12,7	33 m	1
201361-016	Q-98	16	33 m	1
201361-020	Q-99	20	33 m	1
201361-025	Q-112	25,4	33 m	1



Applikationswerkzeug für Klebebänder

MOD 1040

Zubehör	
201040	1

NEW

Q-INFO | MOD 1360 / 1361 / 1362

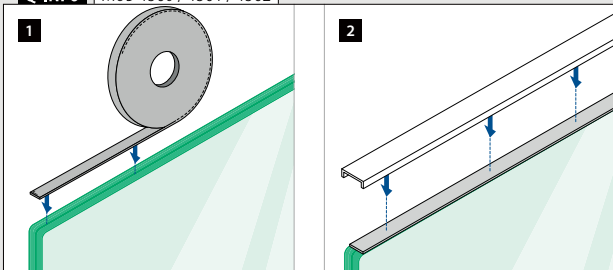

Q-INFO | MOD 0620

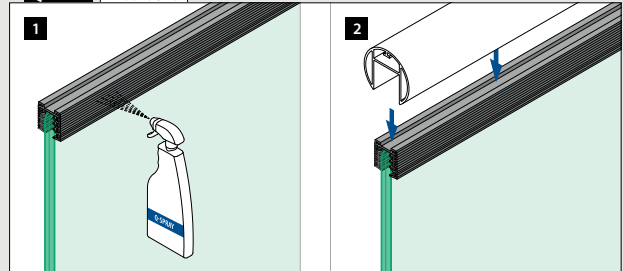

Q-INFO | MOD 1040

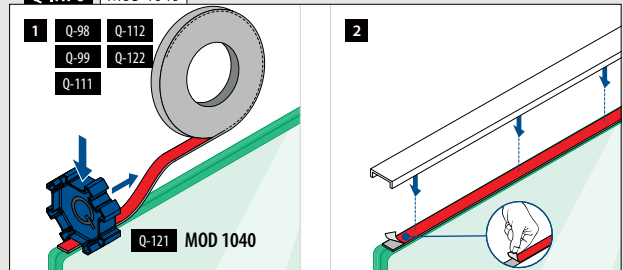



Montagezubehör

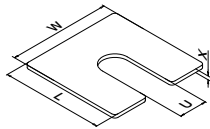

Unterlegscheiben zur Bodenmontage

**MOD 8216** - Easy Glass® Smart

	Aluminium		Roh		
	W	L	U	X	
168216-001	58	58	16	1	100
168216-002	58	58	16	2	100
168216-003	58	58	16	3	100

**MOD 8416** - Easy Glass® Prime

	Aluminium		Roh		
	W	L	U	X	
168416-001	69	69	24	1	100
168416-002	69	69	24	2	100
168416-003	69	69	24	3	100

**MOD 8516** - Easy Glass® Max

	Aluminium		Roh		
	W	L	U	X	
168516-001	78	78	24	1	100
168516-002	78	78	24	2	100
168516-003	78	78	24	3	100

**MOD 8616** - Easy Glass® Strong

	Aluminium		Roh		
	W	L	U	X	
<b>NEW</b> 168616-001	93	93	24	1	100
<b>NEW</b> 168616-002	93	93	24	2	100
<b>NEW</b> 168616-003	93	93	24	3	100

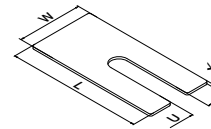

Unterlegscheiben zur Seitenmontage

**MOD 8236** - Easy Glass® Smart

	Aluminium		Roh		
	W	L	U	X	
168236-001	58	120	16	1	100
168236-002	58	120	16	2	100
168236-003	58	120	16	3	100

**MOD 8336** - Easy Glass® Smart+

	Aluminium		Roh		
	W	L	U	X	
<b>NEW</b> 168336-001	58	122	16	1	100
<b>NEW</b> 168336-002	58	122	16	2	100
<b>NEW</b> 168336-003	58	122	16	3	100

**MOD 8436** - Easy Glass® Prime

	Aluminium		Roh		
	W	L	U	X	
168436-001	58	135	16	1	100
168436-002	58	135	16	2	100
168436-003	58	135	16	3	100

**MOD 8636** - Easy Glass® Strong

	Aluminium		Roh		
	W	L	U	X	
<b>NEW</b> 168636-001	58	144	16	1	100
<b>NEW</b> 168636-002	58	144	16	2	100
<b>NEW</b> 168636-003	58	144	16	3	100

**MOD 6636** - Easy Glass® Up

	Aluminium		Roh		
	W	L	U	X	
166636-001	58	89	16	1	100
166636-002	58	89	16	2	100
166636-003	58	89	16	3	100

Nivellierblock für Easy Alu

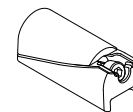

**MOD 9027**

	Aluminium		Roh	
	OUTDOOR	Q		
169027		Q-4	1	



Montageplatten für Easy Glass®

**MOD 1006**

	Zubehör		Stärken	
	Q			
201006	Q-62		1, 2, 3, 4, 5 mm	520

**Q-INFO** MOD 1006

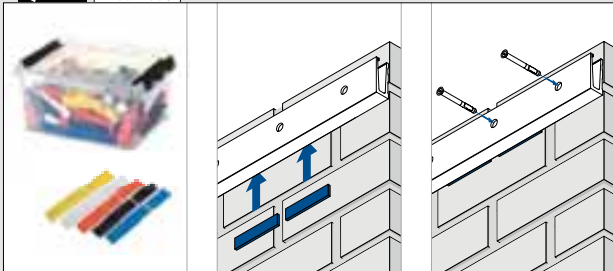

**Q-INFO** MOD 8x16

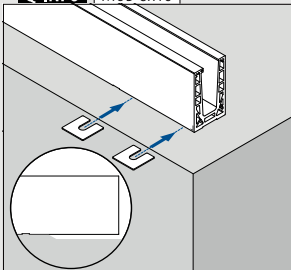

**Q-INFO** MOD 8x36 / 6636

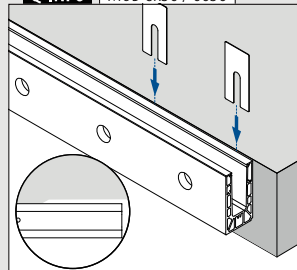

**Q-INFO** MOD 9027

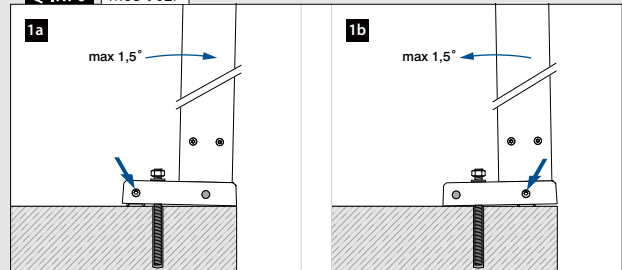

Pflege und Reinigung



Q-cleaner  
Edelstahl-Reinigungsspray,  
konzentriert, ohne Freibgas

MOD 0601

Zubehör			
	Q	e	
200601	Q-23	300 ml	1



Q-ultra-clean  
Chemischer Passivator und Edelstahl-  
reiniger (zur Starkschmutz- und  
Rostentfernung).

MOD 0610

Zubehör			
	Q	e	
200610	Q-22	500 ml	1



Q-protector  
Schützt Aluminium- und Edelstahl-  
komponenten direkt nach der Montage

MOD 0602

Zubehör			
	Q	e	
200602	Q-63	500 ml	1



Scotch®-Brite  
Sehr feine Handschleifpads  
Zum Entfernen von Kratzern auf  
Edelstahlprodukten

MOD 0640

Zubehör		
	Q	
200640	Q-25	10



Q-glass tex  
Glas-Reinigungstücher,  
100% Viskose, 33x37cm

MOD 0660

Zubehör		
	Q	
200660	Q-27	20



Lackstift zur Ausbesserung von Kratzern

MOD 0802

Zubehör		Farbe	e	
	200802-31	Schwarz, RAL 9005	12 ml	1
	200802-33	Anthrazitgrau, RAL 7016	12 ml	1
	200802-34	Telegrau 4, RAL 7047	12 ml	1

Q-INFO | MOD 0640 / 0610

<p>Q-25</p>	<p>MOD 0610 Q-21 Q-ultra-clean</p>
-------------	--

Q-INFO

<p>Reinigung und Pflege- informationen  9</p>
---



Werkzeuge



Sechskant-Schraubendreher-Satz,  
7-teilig

**MOD 1010**

Zubehör

SELL OUT	201010	Q-2	Q-2,5	Q-3	Q-4	Q-5	Q-6	Q-8	Q (□)	1
----------	--------	-----	-------	-----	-----	-----	-----	-----	-------	---



Sechskant-Schraubendreher

**MOD 1008**

Zubehör

SELL OUT	201008-10	Q-10	Q (□)	1
----------	-----------	------	-------	---



Zange für Blindnietmutter

**MOD 1031**

Zubehör

SELL OUT	201031	Q-29	Ø	M6, M8, M10	Q (□)	1
----------	--------	------	---	-------------	-------	---



Kunststoffhammer

**MOD 1030**

Zubehör

201030	Q-45	Q	1
--------	------	---	---



Multiwasserwaage für Rohr, rund und eckig

**MOD 1034**

Zubehör

201034	Q-46	Q	1
--------	------	---	---



Hakenschlüssel

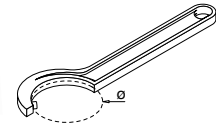

**MOD 1013**

Zubehör

	Q	Ø	1
201013-025	Q-30	25 - 28	1
201013-030	Q-31	30 - 32	1
201013-050	Q-32	45 - 50	1
201013-060	Q-33	58 - 62	1
201013-070	Q-51	68 - 75	1



Zweilochmutterdreher für Ø 3 mm  
Löcher, Pin 2,9 mm, Abstand 15 mm

**MOD 1032**

Zubehör

	Q	1
201032	Q-78	1



Zange für Zweilochmuttern, für Ø 2 mm  
Löcher, Pin 4,0 mm, Abstand 28 mm

**MOD 1033**

Zubehör

	Q	1
201033	Q-110	1



Multiwasserwaage für □ 40, Ø 42,4,  
Ø 48,3 mm

**MOD 1035**

Zubehör

	Q	1
201035	Q-72	1

**SELL OUT** Nur solange der Vorrat reicht.

**Q-INFO** MOD 1034



**Q-INFO** MOD 1035



**Q-INFO** MOD 1035



Werkzeuge



Q-disc®- und Inlay-Werkzeug

MOD 1000

Zubehör		
	Q	
201000	Q-84	1



Easy Glass® Multitool

MOD 1001

Zubehör		
	Q	
201001	Q-71	1



Q-glass Saugheber, 2-Kopf, Tragkraft/Tragrichtung: 60 kg / parallel

MOD 1060

Zubehör		
	Q	
201060	Q-28	1



Glasmontagehilfe

MOD 1062

Zubehör		
	Q	
201062	Q-56	2



Plattentragehilfe  
Spannweiten bis 80 mm  
Maximallast pro Stück: 100 kg

MOD 1061

Zubehör		
	Q	
201061	Q-55	2

SELL  
OUT

WERKZEUG

ZUBEHÖR

**Q-INFO** MOD 1000

- 1 Fixieren und Ausrichtung prüfen
- 2 Drehen
- 3 Ausrichten
- 4 Fixieren
- 5 Prüfen Sie die Montageanleitung zum Einstellen des Drehmomentschlüssels
- 6 Q-spray 200620

**Q-INFO** MOD 1001

- 1
- 2
- 3

**Q-INFO** MOD 1061

- 1
- 2
- 3

**Q-INFO** MOD 1062

- 1
- 2

## Werkzeuge



Fast Fix Entriegelungswerkzeug

## MOD 7802

V4A	316	Gebürstet		
OUTDOOR		Für Kabel Ø		
207802-003		3,2		1
207802-004		4,0		1



Drahtseil-Schere

## MOD 7800

Zubehör				
	Q	Für Kabel Ø		
207800	Q-39	1,5 - 4,0		1

Edelstahl sollte mit einer geeigneten Säge geschnitten werden, um effizientes Arbeiten und ein optimales Ergebnis zu ermöglichen. Um dies zu gewährleisten hat die Edelstahlsäge einen extra starken aber langsam drehenden Motor. Das geringe Gewicht macht diese Säge zum professionellen Begleiter auf der Baustelle.

201070-23  
Q-34

Montagesäge

Motor 0,8 kW - 230 V, 60 rpm, Kühlautomatik, 17 kg, Maße 490x425x600 (LxBxH), exklusive Sägeblatt, für gerade Zuschnitte

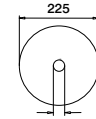
201071  
Q-35Untergestell für  
Montagesäge201072  
Q-36Sägeblatt für  
MontagesägeHSS, 225 x 2,2 x 32,  
168 Z201074  
Q-38Höhenverstellbare  
Materialauflage mit  
Kugelführung für Rohre  
mit Ø26-168 mm201073  
Q-44Außen-/Innen-  
Rohrentgrater,  
für Rohre mit  
Ø10-54 mm

## MOD 1070 / 1071 / 1072 / 1073 / 1074

## Zubehör

	Q	
201070-23	Q-34	1
<small>SELL OUT</small> 201071	Q-35	1
201072	Q-36	1
201073	Q-44	1
<small>SELL OUT</small> 201074	Q-38	1

























































## SUCHEN SIE NACH Q-RAILING PROMOTIONARTIKEL?

Dann erkundigen Sie sich bei uns nach Displays, Mustersets und anderen Möglichkeiten.



Q-railing

# SYMBOLVERZEICHNIS

<b>V2A</b>	<b>304</b>	304 Edelstahl (V2A)	<b>(Verbund-)Sicherheitsglas</b>	Monolithisch	Glas
<b>V4A</b>	<b>316</b>	316 Edelstahl (V4A)	<b>(Verbund-)Sicherheitsglas</b>	ESG/VSG	
	<b>Aluminium</b>	Aluminium	<b>Buche</b>	<b>Eiche</b>	Holz
	<b>Kunststoff</b>	Kunststoff	<b>Kambala</b>	<b>Holz</b>	
	<b>Stahl</b>	Stahl	Gebürstet	Hochglanzpoliert	Materialoberfläche
	<b>Zinkdruckguss</b>	Zinkdruckguss	<b>INDOOR</b>		Für Innenanwendung
	<b>Stahl, verzinkt</b>	Stahl, verzinkt	<b>OUTDOOR</b>		Für Außenanwendung
	<b>Messing</b>	Messing			
 /  /  / $\emptyset$		Form/Größe des Rohrs/Glasleistenrohrs			Größe des Bohrkopfes
		Extra Produktinformation	 QS-36  469 / QS-36		Diese Q-Anker benutzen, siehe Seite 469
<b>T</b>		Glasstärke	 QS-53  474 / QS-53		Diese Q-Schraube benutzen, siehe Seite 474
		Verpackungseinheit	Q-22		Dieses Werkzeug benutzen
<b>NEW</b>		Neues Produkt			CE-Kennzeichnung
<b>SELL OUT</b>		Ausverkaufartikel (nur verfügbar solange der Vorrat reicht)	<b>EXTRA STRONG</b>		Extra stark
<b>PREFIX</b>		Prefix-Optionen verfügbar			
 		Versand per Spedition			AVIS Technique-Label
		Produkt wird geschraubt (Sechskant-Schraubendreher)			Geprüft von CSTB
		Drehmomentschlüssel	 		SIA 358:2010 / SIA 261:2014
		Produkt wird geschraubt (Schlüssel)	 		Geprüft gemäß EN 1991 / EN 1990
		Hakenschlüssel			Geprüft gemäß NEN 2608 (Eurocodes 1990-1999:2011)
		Schraubendreher			LGA Typen geprüft-Label
		Vielzahn-Schraubendreher			Statische Berechnung gemäß DIN 18008
		Produkt wird eingeschlagen (Easy Hit®)			CTE-Label
		Produkt wird geklebt			Geprüft von Applus
		Produkt wird geschnitten			Geprüft gemäß NTC UNI 11678-2017
		Produkt wird gesägt			Geprüft gemäß DIN 18008
		Produkt wird geschweißt			Geprüft von WTCB.be & CSTC.be
		AW-Antrieb			Geprüft gemäß NBN B03-004
		90° Ecke nicht möglich			Geprüft gemäß Miami Dade County
		Wandabstand 85 mm			Geprüft von International ICC Evaluation Service
		AbP-Label (Allgemeines bauaufsichtliches Prüfzeugnis)			IK-Code (Stoßfestigkeitswert)
		ETB-Label			Farbwiedergabe-Index
		AbZ-Label (Allgemeine bauaufsichtliche Zulassung)			Dali Lighting Control
		Gemäß DIN/EN 12600 geprüft			Minimaler Biegeradius
		Gemäß British Standard 6180 geprüft			Installation durch eine zugelassene Elektrofachkraft
		Verrotec-Label			





© 2023 Q-railing  
Emmerich am Rhein, Deutschland

**Urheberrecht / Copyright**

Die Gestaltung, das Layout dieses Kataloges, Texte, Textteile, Tabellen, Bilder, Marken, Warenzeichen, Logos, Grafiken und andere Inhalte dieses Kataloges stehen entweder im Eigentum der Q-railing Europe GmbH & Co. KG, Deutschland oder werden mit Einwilligung des Eigentümers verwendet. Sie unterliegen weltweitem Urheberrecht. Soweit nicht anders angegeben sind alle in diesem Katalog verwendeten Marken und Warenzeichen sowie Kennzeichenrechte, Geschmacksmuster und Gebrauchsmuster Eigentum der Q-railing Europe GmbH & Co. KG, Deutschland oder unserer Geschäftspartner. In Deutschland und in vielen anderen Ländern ist sowohl eine strafrechtliche als auch eine zivilrechtliche Verfolgung von Verstößen gegen das Urheberrecht, Markenrecht und weiterer Schutzrechte möglich. Sollten Sie einzelne Inhalte oder komplette Seiten verwenden, kopieren, reproduzieren, im weitesten Sinne verändern, übersetzen und oder an Dritte weiterreichen oder weiterreichen wollen, so benötigen Sie unsere Einwilligung, welche wir nur schriftlich im Voraus erteilen. Fragen Sie uns also bitte vorab. Anderenfalls behalten wir uns rechtliche Schritte gegen Sie vor.



## BITTE BEACHTEN

Fertigungstechnische Änderungen sowie Maßabweichungen bleiben vorbehalten. Die Originalprodukte können sich von den Fotodarstellungen geringfügig unterscheiden. Ein Reklamationsanspruch entsteht hieraus nicht. Druckfehler vorbehalten. Eine Haftung von Q-railing, gleich aus welchen Rechtsgründen, ist ausgeschlossen, sofern nicht rechtlich zwingend gehaftet wird. Hier begrenzt sich die Haftungssumme auf den reinen Warenwert des Auftrages, eine darüber hinaus gehende Haftungssumme ist ausgeschlossen. Bitte beachten Sie die gesetzlichen Vorgaben, die von Land zu Land unterschiedlich sein können. Q-railing haftet nicht für Auflagen und Bestimmungen, die für den jeweiligen Montageort Gültigkeit haben.

**Es gelten unsere allgemeinen Geschäftsbedingungen. Diese finden Sie auf [www.q-railing.com](http://www.q-railing.com).**





# THE PREMIUM BRAND IN RAILING SYSTEMS

**Q-railing Central Europe GmbH**  
**Niederlassung Emmerich**  
Marie-Curie-Straße 8-14  
46446 Emmerich am Rhein  
Deutschland

T. +49 2822 915 69 0  
F. +49 2822 915 69 70  
WhatsApp +49 152 0865 1286  
sales.de@q-railing.com

**Q-railing Central Europe GmbH**  
**Niederlassung München**  
Hanns-Schwindt-Straße 8  
81829 München  
Deutschland

T. +49 89 24887 460  
F. +49 89 24887 469 9  
WhatsApp +49 152 0865 1286  
sales.de@q-railing.com



Q-RAILING CATALOGUE 2023, CE-DE • LANGUAGE DE • NO CURRENCY • 911002-011-02-00